



**Fernbedienungsschema
Remote Control Pattern
Schéma de Télécommande**



Fernbedienungschema

HDS 9/14 ST Eco, HDS 12/14 ST Eco
 HDS 9/16 ST GAS, HDS 9/16 ST GAS LPG
 HDS 12/14 ST GAS, HDS 12/14 ST GAS LPG
 Reinigungsmittelspeisung ueber die Pumpe
 Reinigungsmittel ueber Fernbedienung
 waelhbar bei ABS-RM

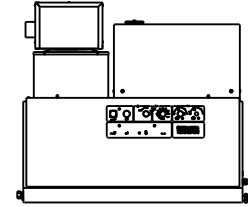
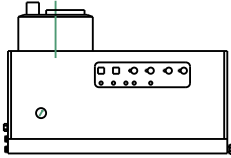

Anzahl Fernbedienungen

1 FB

max. 2 FB

1-6 FB
+ 1 Muenzfernbedienung

Not-Aus

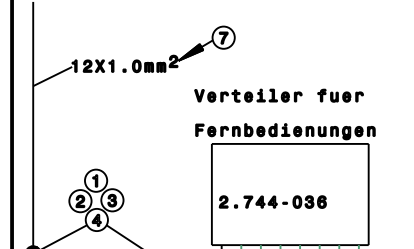
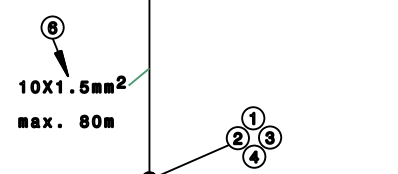
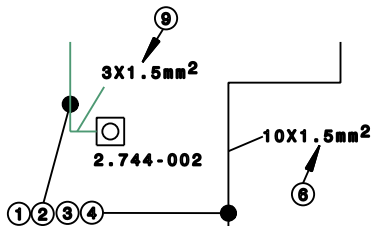

Prioritaetschalter/ Steuer-elektronik

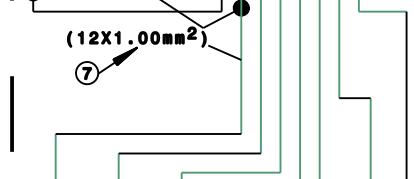
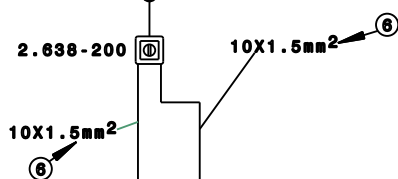
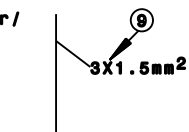

Fernent-riegelung

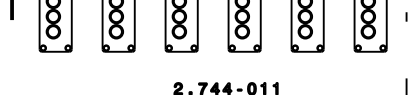

Fernbe-dienung/ Muenzfern-bedienung

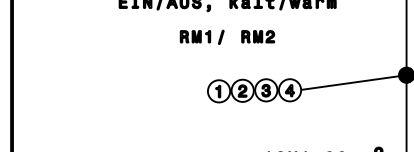
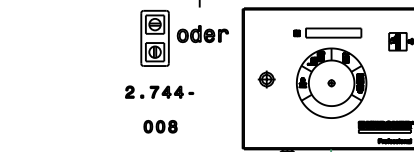
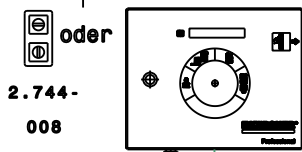

Klarspuelen

Klarspuelen

RM1/ Klarspuelen/ RM2

RM1

RM1

RM2

RM2

2.642-422

2.642-422

2.642-422

ABS Reinigungsmittel

1x RM
2x RM

2.637-779
2.637-717

INFO = Alle Muenzfernbedienungen werden ohne Muenzpruefer ausgeliefert.

Fernbedienungschema

HD 6/16 ST-H
 HD 9/16 ST-H
 HD 13/12 ST-H
 Reinigungsmittleinspeisung ueber die Pumpe
 Reinigungsmittel ueber Fernbedienung
 wahlbar bei ABS-RM

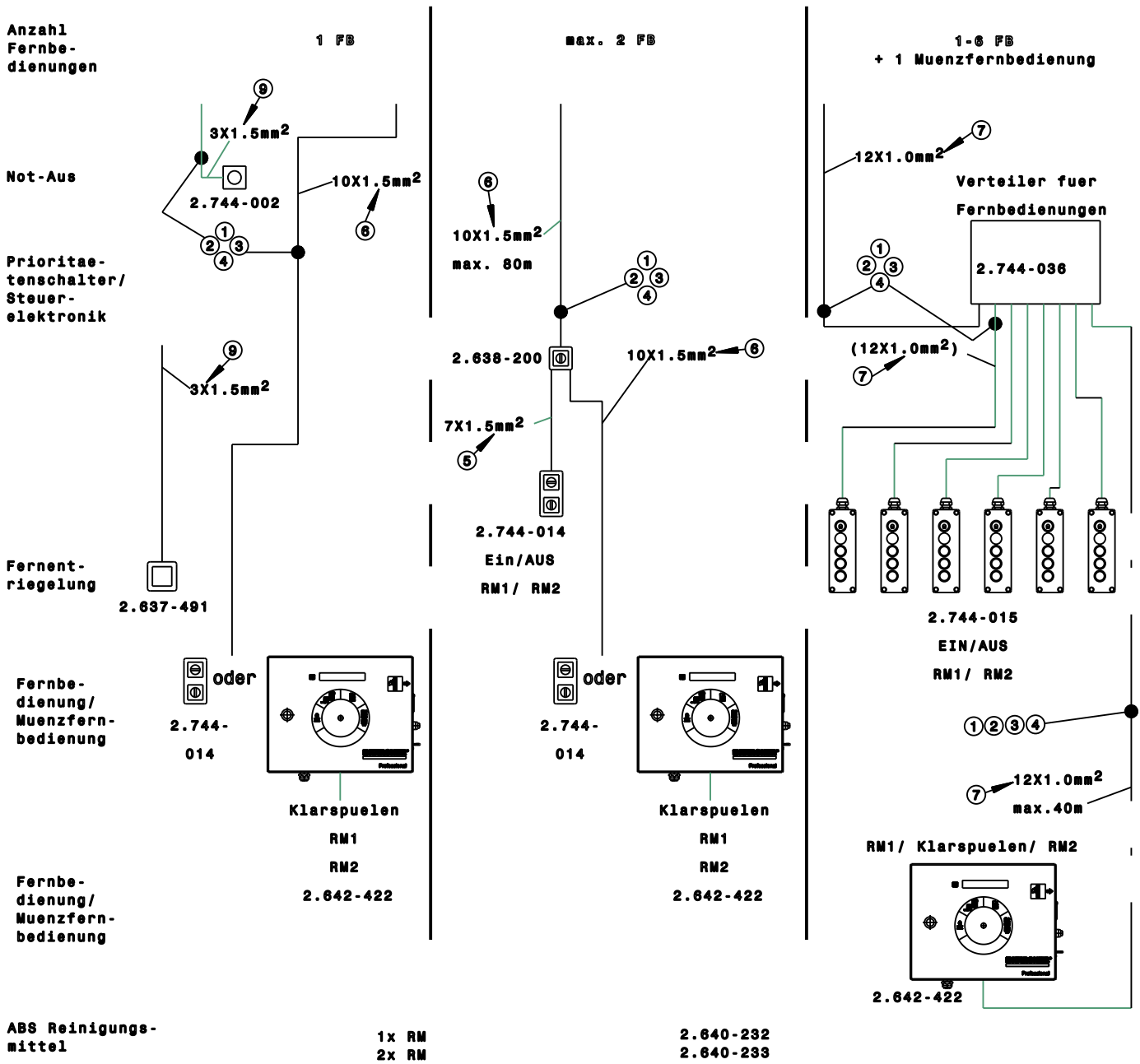

INFO = Alle Muenzfernbedien-ung werden ohne Muenzpruefer ausgeliefert.

Fernbedienungschema

HD 6/16 ST
 HD 6/15 ST
 HD 9/16 ST
 HD 13/12 ST

Reinigungsmiteleinsepfung
 ueber eingebauten Injektor
 u. RM-Dosierventil

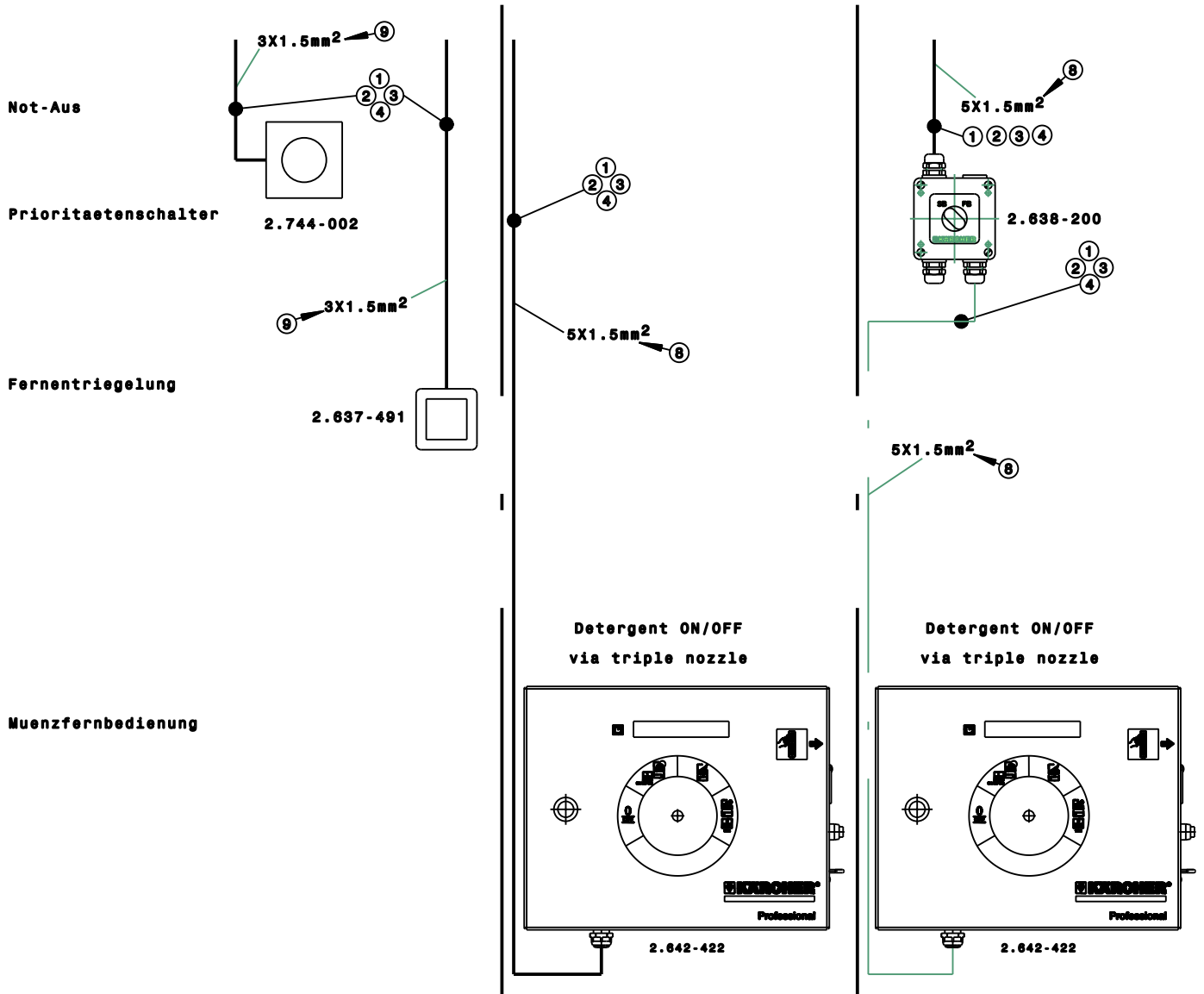
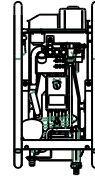

INFO = all coin remote controls
 are delivered without coin tester

Fernbedienungschema

HD 7/16-4 ST/ ST-H
HD 9/18-4 ST/ ST-H
HD 13/12-4 ST/ ST-H

Reinigungsmittelspeisung ueber die Pumpe
Reinigungsmittel ueber Fernbedienung
wahlbar bei ABS-RM

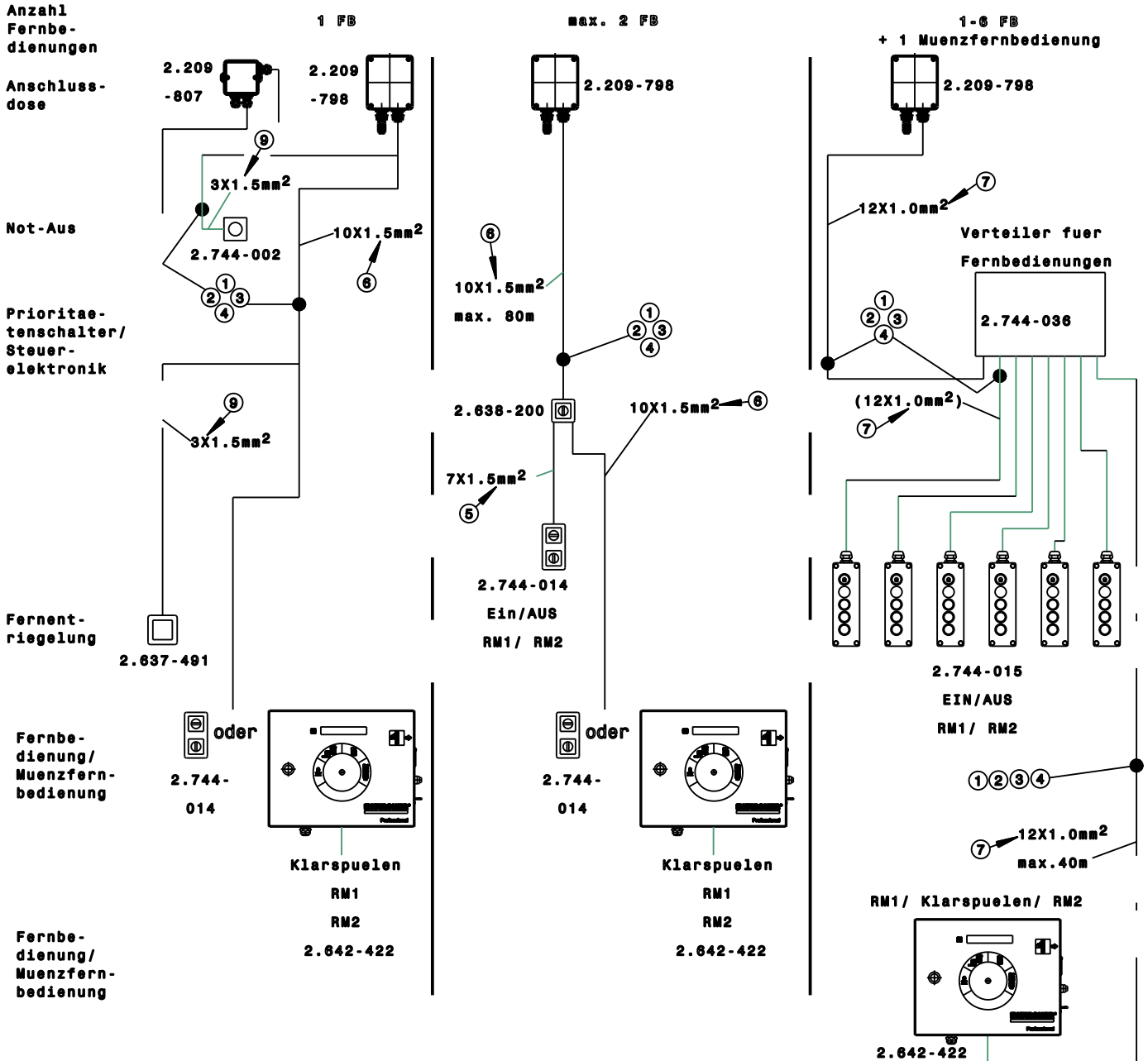

ABS Reinigungs-
mittel

- 1x RM Ausbringungim Niederdruckstrahl 2.209-779
- 2x RM Ausbringungim Niederdruckstrahl 2.209-780
- 1x RM Ausbringungim Hochdruckstrahl 2.209-799
- 2x RM Ausbringungim Hochdruckstrahl 2.209-800

INFO = Alle Muenzfernbedienung werden ohne
Muenzpruefer ausgeliefert.

Remote control pattern

HDS 9/14 ST Eco, HDS 12/14 ST Eco
 HDS 9/16 ST GAS, HDS 9/16 ST GAS LPG
 HDS 12/14 ST GAS, HDS 12/14 ST GAS LPG
 Detergent feed via pump
 Detergent feed can be selected via remote control in detergent accessory kit

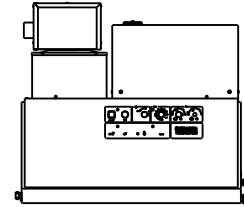
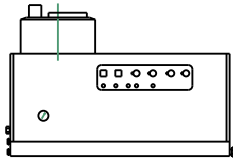

Number of remote controls 1 Remote control

max. 2 Remote controls

1-6 Remote control + 1 Coin remote control

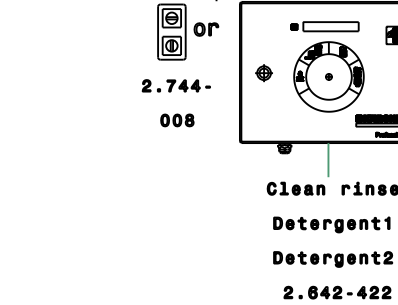
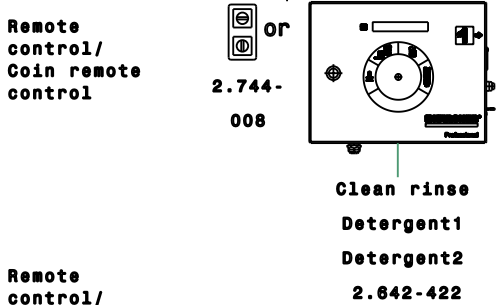
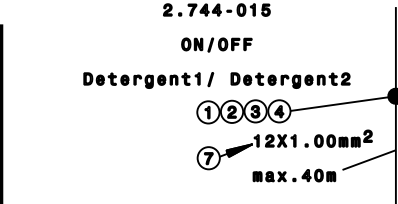
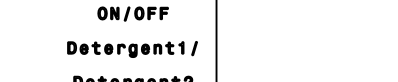
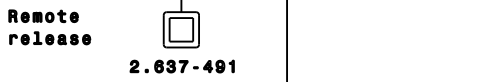
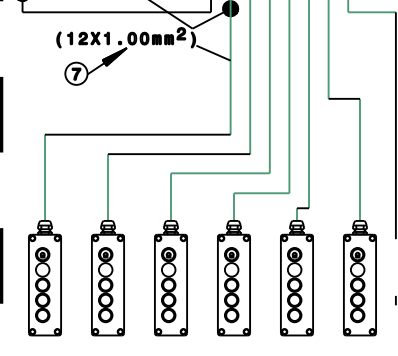
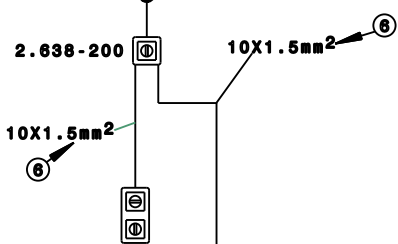
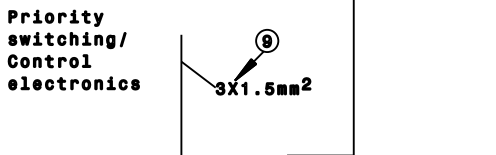
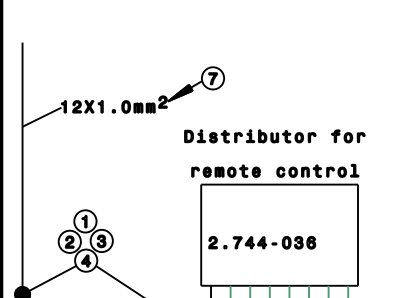
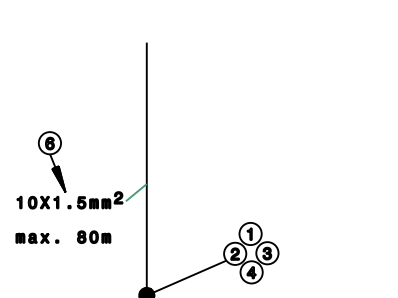
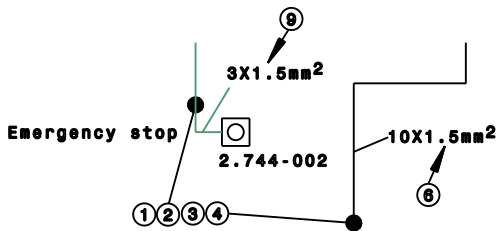

Accessory kit Detergent

1x Detergent 2.637-779
 2x Detergent 2.637-717

INFO = all coin remote controls are delivered without coin tester

Remote control pattern

HD 6/16 ST-H
HD 9/16 ST-H
HD 13/12 ST-H

Detergent feed via pump
Detergent feed can be selected via remote control in detergent accessory kit

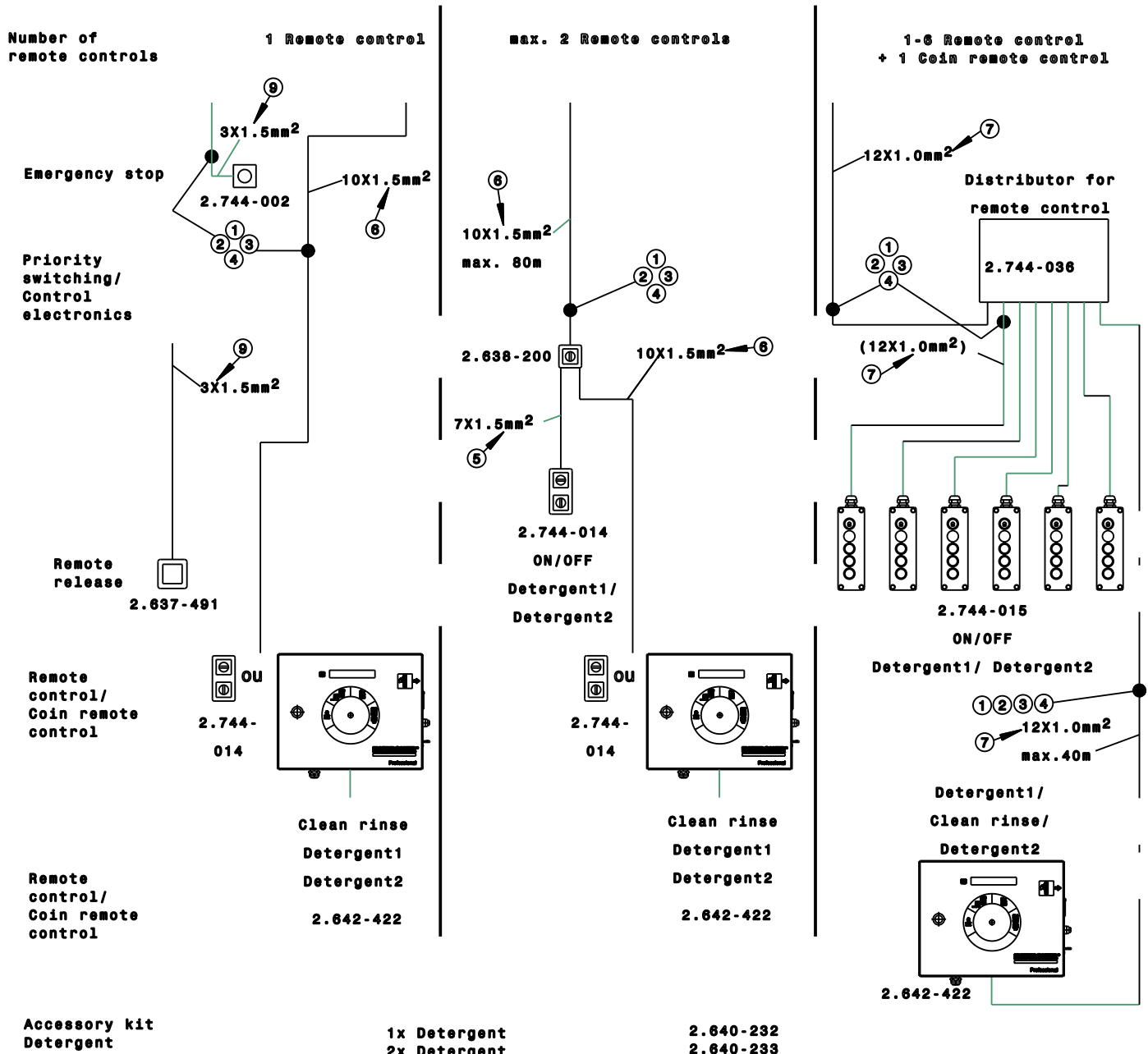
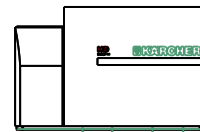

INFO = all coin remote controls are delivered without coin tester

Remote control pattern

HD 6/16 ST
 HD 6/15 ST
 HD 9/16 ST
 HD 13/12 ST

Detergent feed
 via built-in injector and
 detergent dosing valve

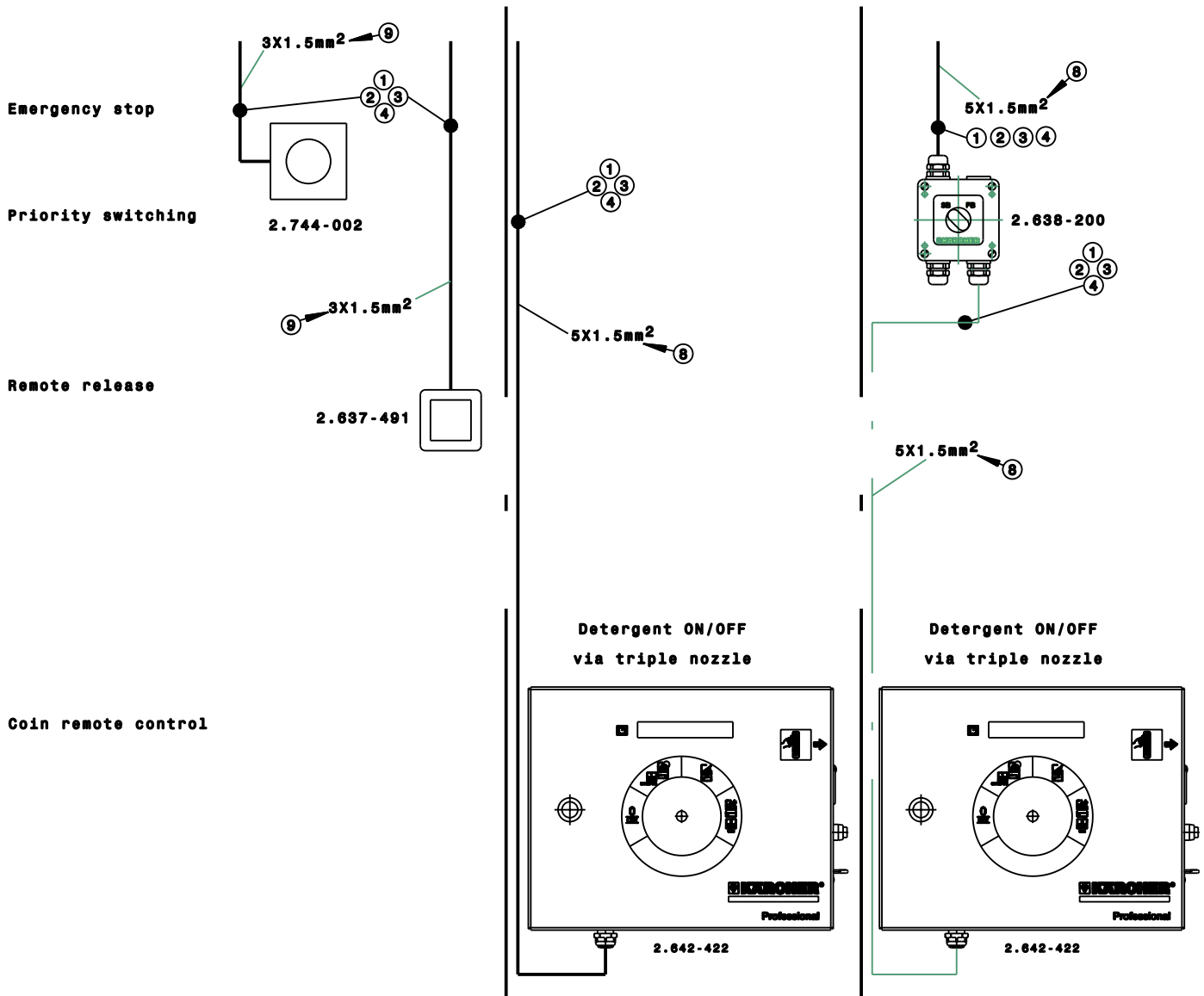
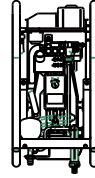

INFO = all coin remote controls
 are delivered without coin tester

Remote control pattern



HD 7/16-4 ST/ ST-H
 HD 9/18-4 ST/ ST-H
 HD 13/12-4 ST/ ST-H
 Detergent feed via pump
 Detergent feed can be selected via remote control in detergent accessory kit



Schéma de télécommande

HDS 9/14 ST Eco, HDS 12/14 ST Eco
 HDS 9/16 ST GAS, HDS 9/16 ST GAS LPG
 HDS 12/14 ST GAS, HDS 12/14 ST GAS LPG
 Alimentation du détergent sélectionnable avec
 la télécommande avec jeu de montage-détergent

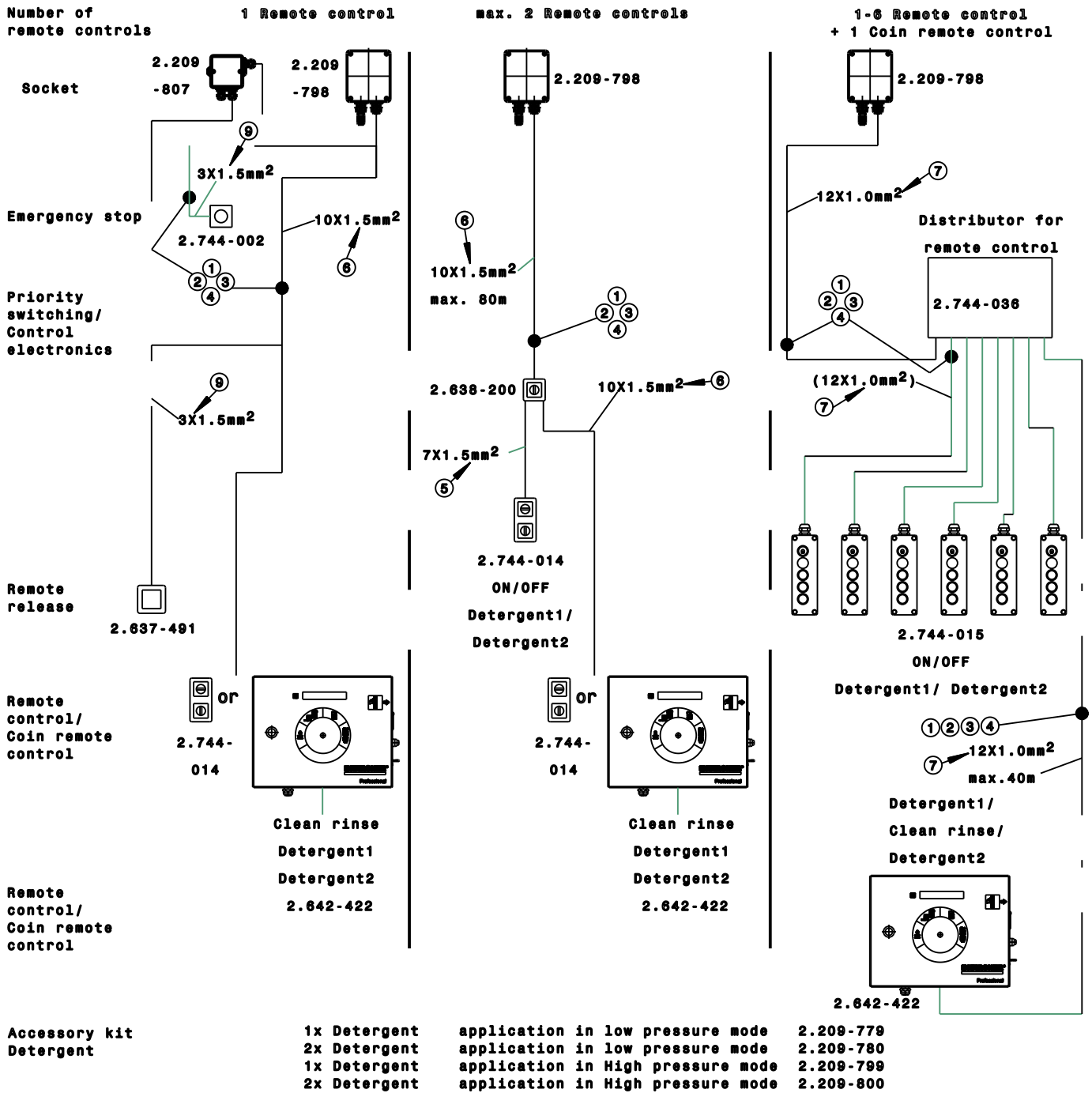
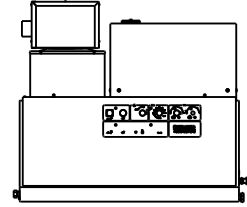
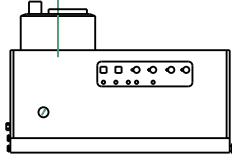

Nombre de télécommandes

1 Télécommande

max. 2 Télécommandes

1-6 Télécommande(s)
 + 1 Télécommande à monnaie

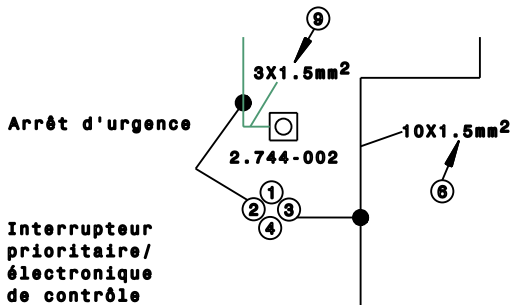

Arrêt d'urgence

Interrupteur prioritaire/
 électronique de contrôle

Déverrouillage à distance

2.637-491

Télécommande/
 Télécommande à monnaie

2.744-008

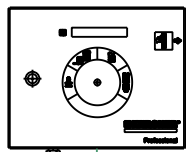

Rincer à l'eau claire
 Détergent1
 Détergent2
 2.642-422

Télécommande/
 Télécommande à monnaie

Jeu de montage détergent

1x Détergent
 2x Détergent

2.640-232
 2.640-233

INFO = toutes les télécommandes à monnaie sont librées sans contrôleur de monnaie

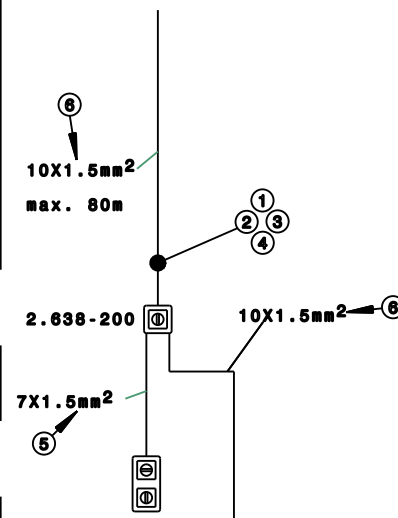

10x1.5mm²
 max. 80m

2.638-200

7x1.5mm²

2.744-014
 marche/ arrêt
 Détergent1/
 Détergent2

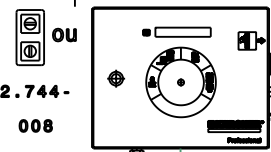

Rincer à l'eau claire
 Détergent1
 Détergent2
 2.642-422

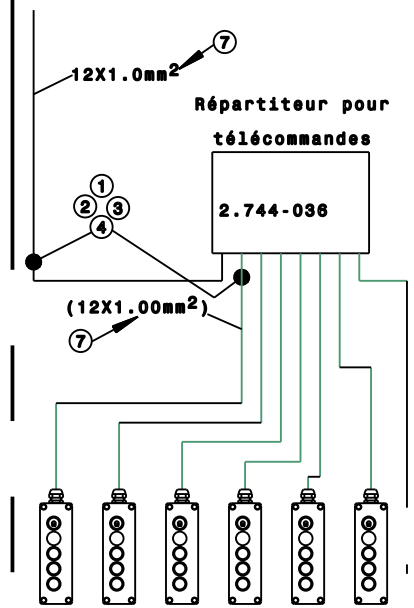

Répartiteur pour télécommandes

2.744-036

(12x1.00mm²)

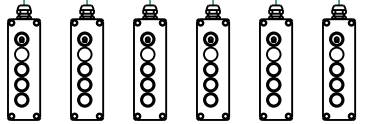

2.744-015

marche/ arrêt
 Détergent1/ Détergent2

12x1.00mm²
 max. 40m

Détergent1/
 Rincer à l'eau claire/
 Détergent2

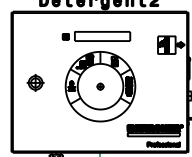

2.642-422

Schéma de télécommande

HD 6/16 ST-H
HD 9/16 ST-H
HD 13/12 ST-H

Alimentation du détergent par la pompe
Alimentation du détergent sélectionnable avec
la télécommande avec jeu de montage-détergent

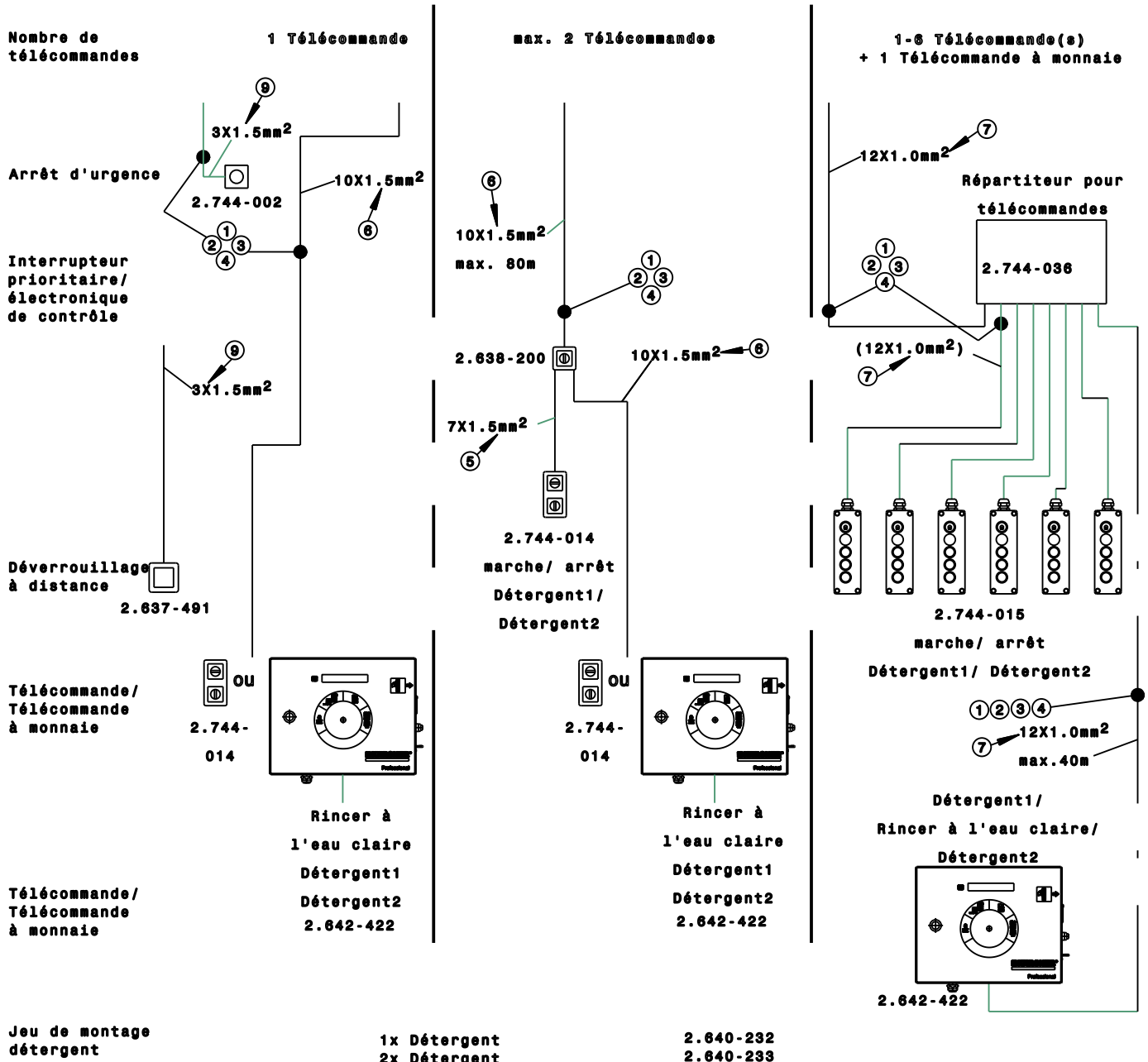
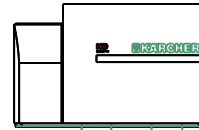

INFO = toutes les télécommandes à monnaie sont librées sans contrôleur de monnaie

Schéma de télécommande

HD 6/16 ST
 HD 6/15 ST
 HD 9/16 ST
 HD 13/12 ST

alimentation du détergent par
 injecteur et valve de dosage
 détergent montés

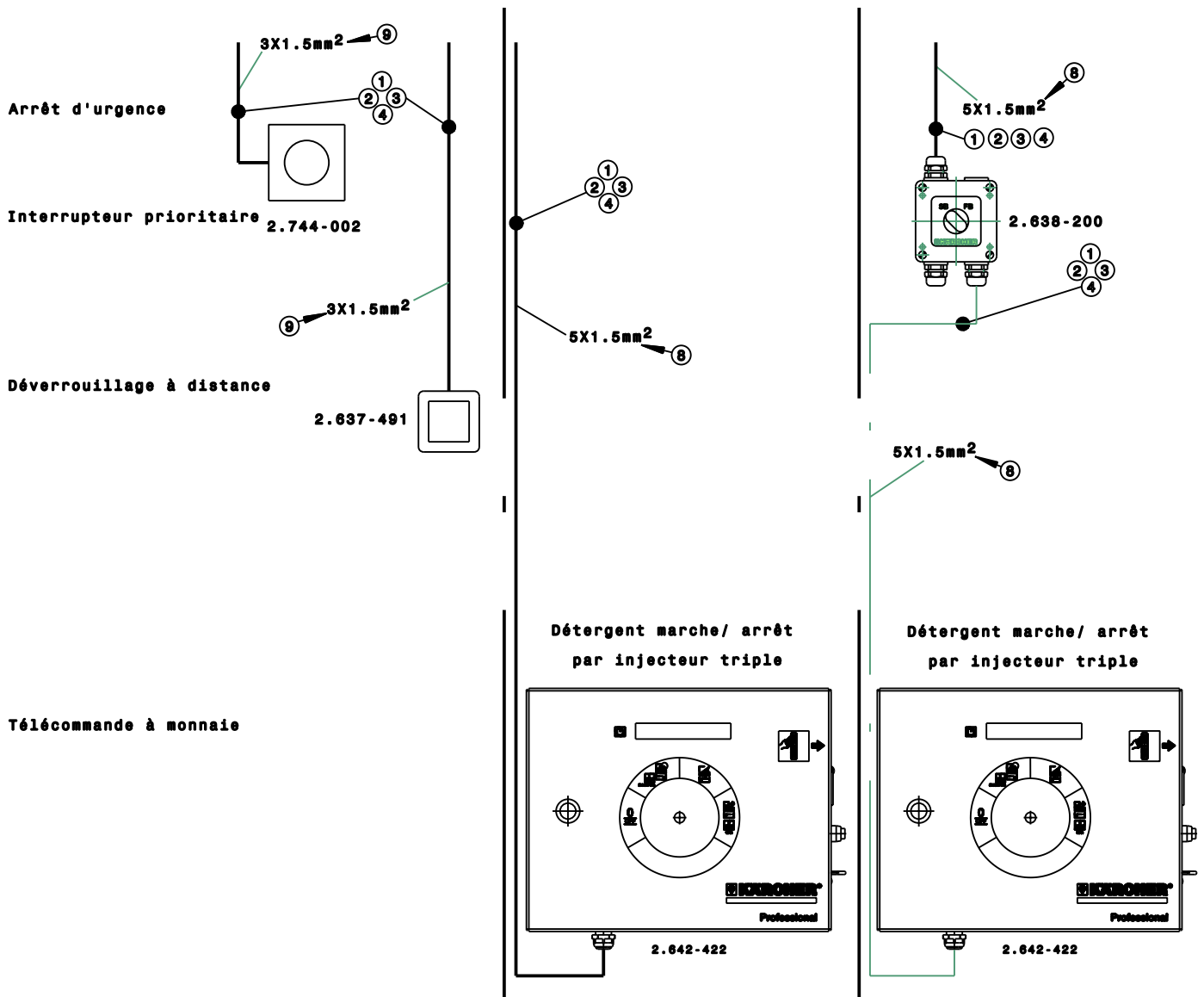
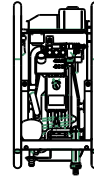

INFO = toutes les télécommandes à monnaie sont
 livrées sans contrôleur de monnaie

Schéma de télécommande



HD 7/16-4 ST/ ST-H
 HD 9/18-4 ST/ ST-H
 HD 13/12-4 ST/ ST-H
 Alimentation du détergent par la pompe
 Alimentation du détergent sélectionnable avec
 la télécommande avec jeu de montage-détergent

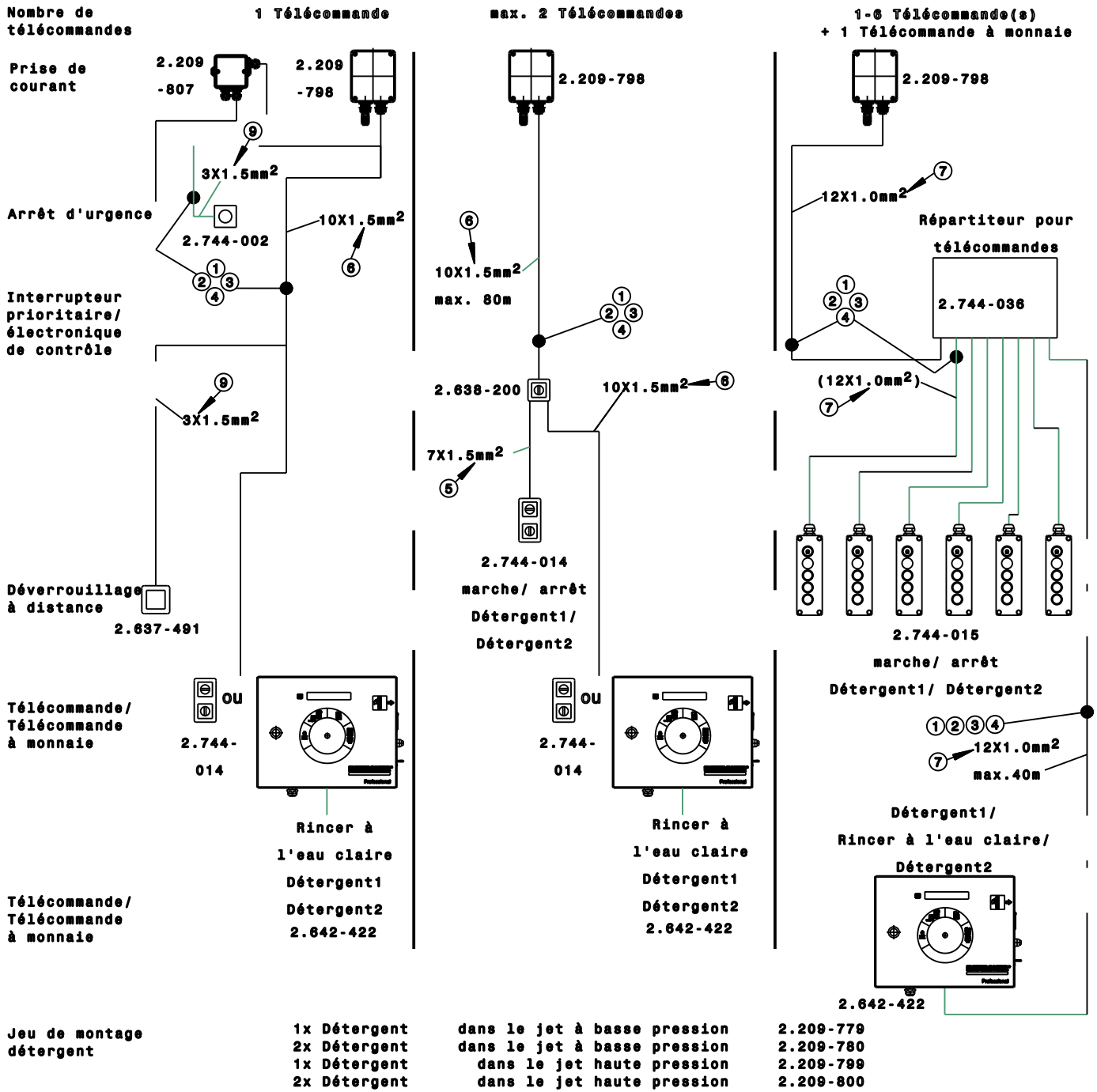

INFO = toutes les télécommandes à monnaie sont librées sans contrôleur de monnaie

Position	Benennung	Teile-Nr.	
1	Klemmschelle Dn 13,5/ Clamp Clip/ Collier de Fixation (5 Stueck je Montagerohr verwenden)	6.373-377.0	
2	Montagerohr Dn 13,5/ Assembly Tube/ Tube de Montage	2.420-008.0	
3	Duebel 6 Pa/ Dowel/ Fenton	6.373-224.0	
4	Holzschraube 4x 35/ Screw/ Vis	7.303-145.0	
5	Steuerleitung 7x1,5/ Control Lead/ Cable de Commande	6.641-064.0	
6	Steuerleitung 10x1,5/ Control Lead/ Cable de Commande	6.641-082.0	
7	Steuerleitung 12x1,0/ Control Lead/ Cable de Commande	6.647-222.0	
8	Steuerleitung 5x1,5/ Control Lead/ Cable de Commande	6.641-061.0	
9	Steuerleitung 3x1,5/ Control Lead/ Cable de Commande	6.641-059.0	