

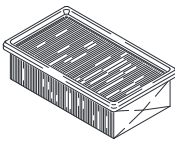

## Filtersysteme / Filter Systems / Système de filtres

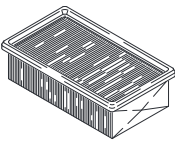





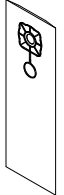

					
	Flachfaltenfilter * Flat pleated filter * Filtre plat à plis *	Flachfaltenfilter (PES) * Flat pleated filter (PES) * Filtre plat à plis (PES) *	Vliesfiltertüte 3-lagig * Fleece filter bag triple layered * Sachet filtre en tissu non tissé à 3 épaisseurs *	Membranfilter Diaphragm filter Filtre à membrane	Spezialfiltertüte, nass Special filter bag, wet Sachet filtre spécial, mouillé
Bestell-Nr. Order No. Numéro de référence NT 25/1	6.904-367	6.904-360	6.907-478	6.904-212	6.904-171
Bestell-Nr. Order No. Numéro de référence NT 35/1	6.904-367	6.904-360	6.907-479	6.904-212	6.904-171
Menge Quantity Quantité	1	1	5	1	5
Normalstäube Normal dust Poussières normales	X		X	X	
Feinstäube Fine dust Poussières fines	X		X	X	
Abrasive Stäube Abrasive dust Poussières abrasives	X		X	X	X
Flüssigkeiten, nasser Schmutz Liquids, wet dirt Liquides, saletés humides		X			X

\* Staubklasse M, Rückhaltevermögen  $\geq 99,9\%$

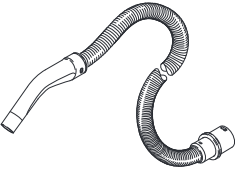
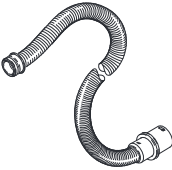

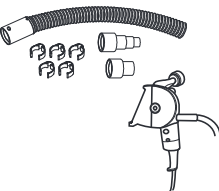



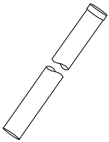

\* Dust class M, Retention  $\geq 99,9\%$

\* Classe de poussière M, Conservation  $\geq 99,9\%$

## Zubehör / Accessories / Accessoires

		$\varnothing$ [mm]		
	4.440-626 4.440-653	CDN 35 CDN 35 EL	2,5 2,5	
	6.906-208 6.906-241 6.906-242 6.906-321 6.906-279 6.906-546 6.906-714	C 35 C 35 C 35 C 40 C 40 C 40 EL C 40 Oil	2,5 4,0 10,0 4,0 10,0 4,0 4,0	
	6.906-237 6.906-277 6.906-344	C 35 C 35 EL C 40 Verlängerung, extension, rallonge	2,5 2,5 2,5	
	2.639-483	DN 35	0,45	
	2.639-484 2.639-485	DN 35/27 DN 35/27 EL	3,5 3,5	
	5.453-042 5.453-052 5.407-112 5.407-111 5.407-113	C 35 EL C 35 EL C 35 - DN 35 C 40 - DN 40 C 40 - C 35		
	5.031-718 5.031-939 5.031-904 5.032-427	DN 35 DN 35 EL C/DN 40 C/DN 40 EL		
	6.900-514 6.900-275	DN 35 M DN 40 M	0,5 0,5	

## Zubehör / Accessories / Accessoires

		∅ [mm]		
	6.906-513 6.906-384 6.906-554 6.903-018 6.906-383	DN 35 DN 35 M DN 40 DN 40 M DN 40 M		360 370 360 370 450
	6.906-511	DN 35		270
	6.900-922 6.903-033	DN 35 M DN 40	0,5 0,29	
	6.902-104 6.902-105	DN 35 DN 40	0,2 0,2	
	6.903-862	DN 35		
	6.900-425 6.903-863	DN 35 hard DN 35 soft	0,25 0,25	

EL = elektrisch leitend, electrical conductive, conducteur électrique

C = Clip-Verbindung, Clip connection, Connexion de clip

DN = Konus-Verbindung, Cone connection, Connexion de cône

M = Metall, metal, métal

Oil = ölbeständig, oil resistant, résistant à l'huile

# NT 25/1 Ap - NT 35/1 Ap

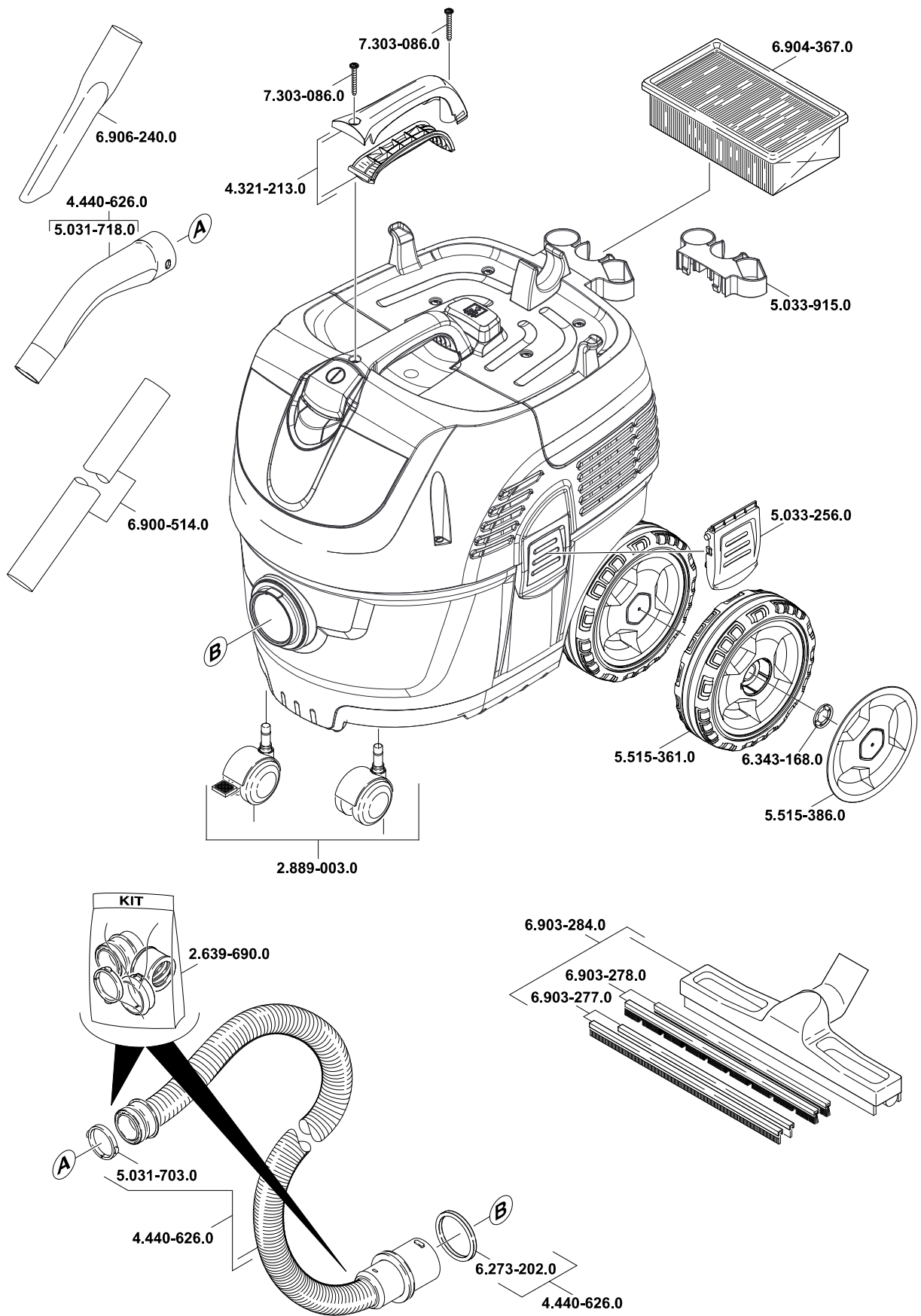

5.965-350.0 19.02.2014

# NT 25/1 Ap Te - NT 35/1 Ap Te

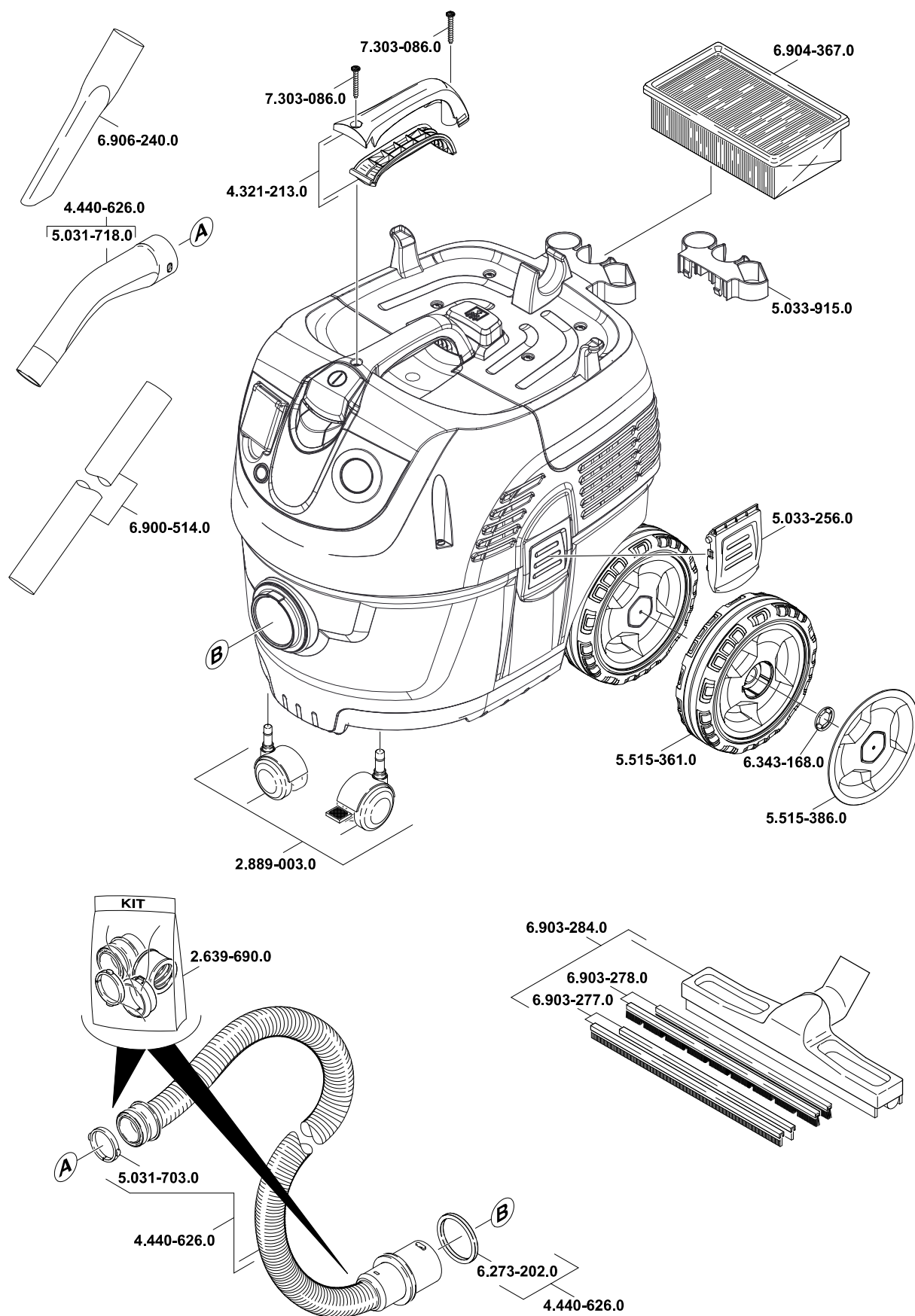

5.965-350.0 11.02.2014