

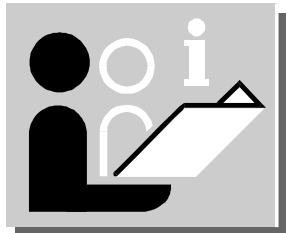

KÄRCHER

HDS Super M Eco
HDS 655 M Eco
HDS 695 M Eco
HDS 895 M Eco
HDS 1195 S Eco

HDS Super MX Eco
HDS 695 MX Eco
HDS 895 MX Eco
HDS 1195 SX Eco

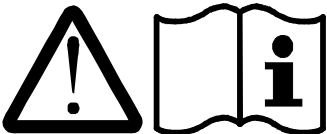
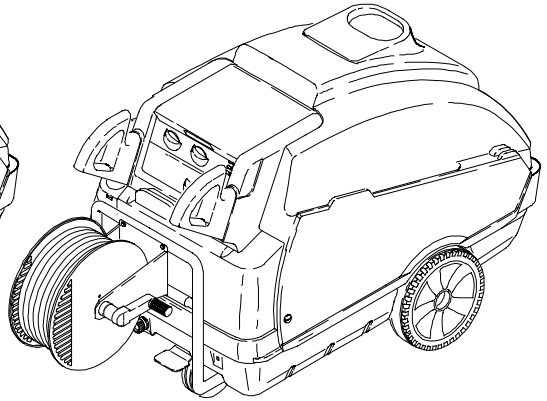
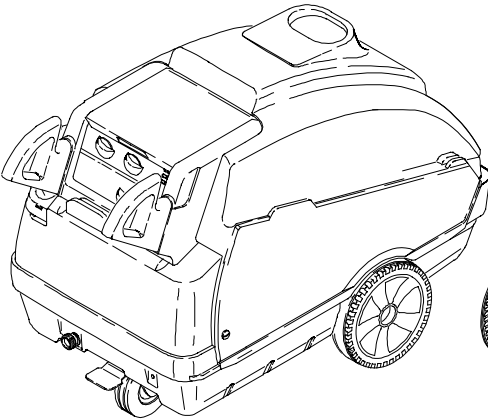

www.kaercher.com

5.961-306 A2008544 05/04

Deutsch	7	Magyar	214
English	24	Česky	231
Français	41	Slovensko	247
Italiano	59	Polska	264
Nederlands	77	Românește	282
Español	94	Türkçe	300
Português	111	Русский	317
Ελληνικά	128	Slovensky	337
Dansk	147	Hrvatski	353
Norsk	164	Srpski	370
Svenska	181	Български	387
Suomi	198		

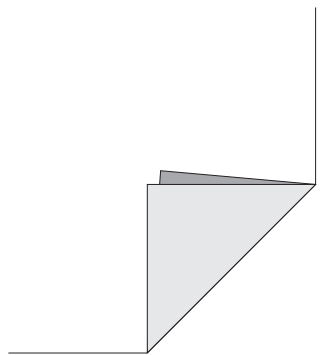

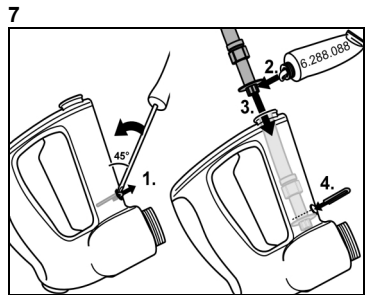
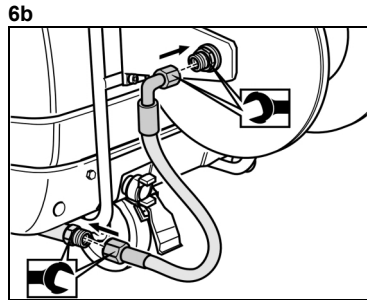
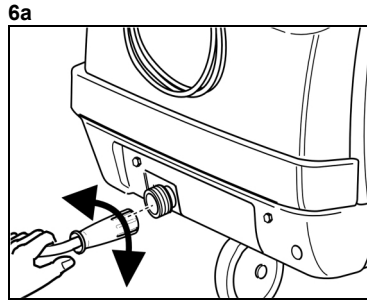
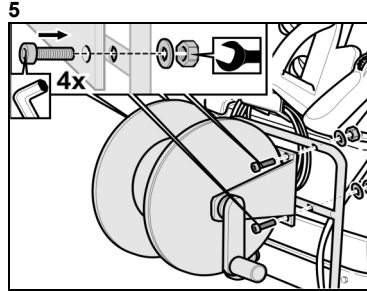
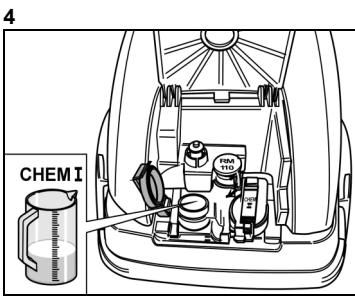
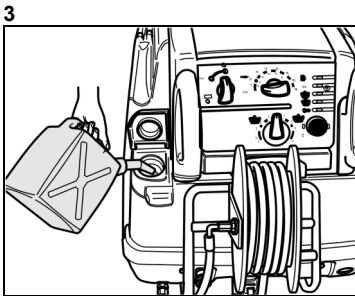
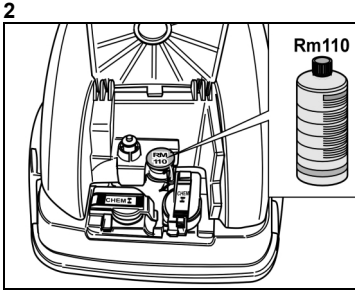
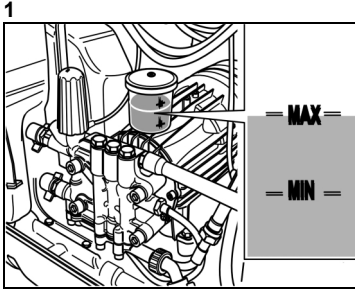

8

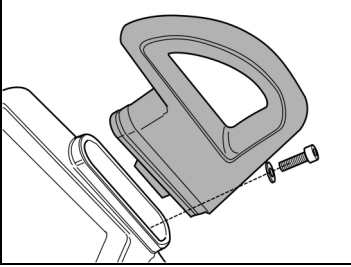

9

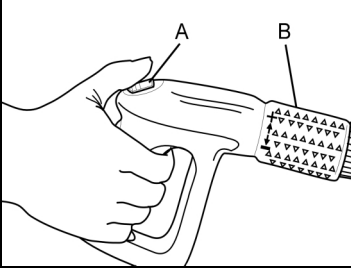

10

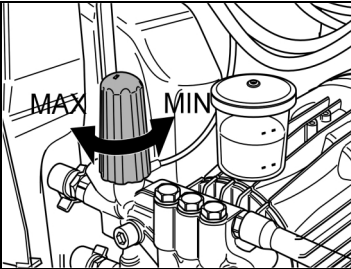

11a

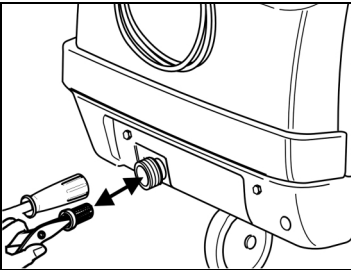

11b

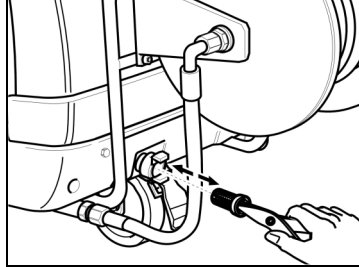

12

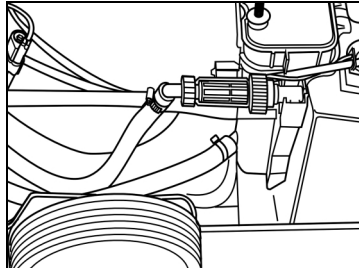

13

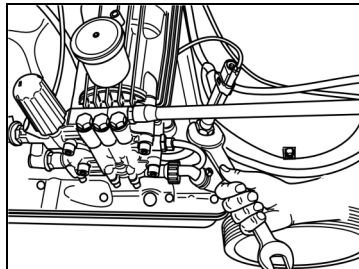

14

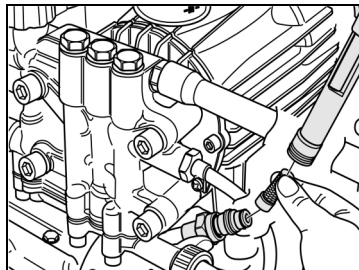

15

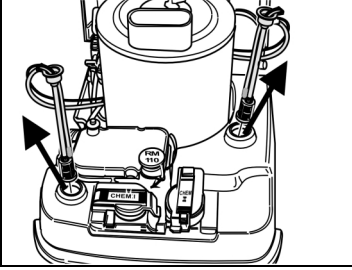

16

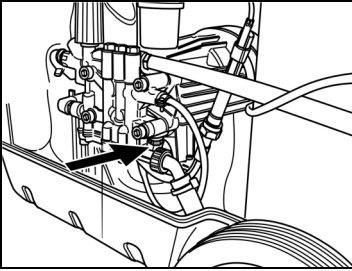

17

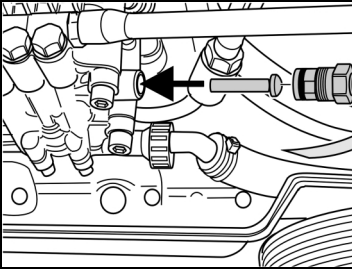

18

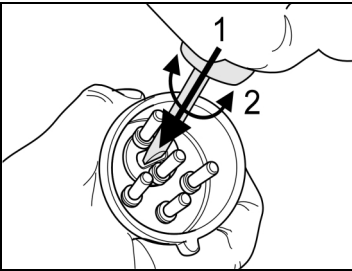

19

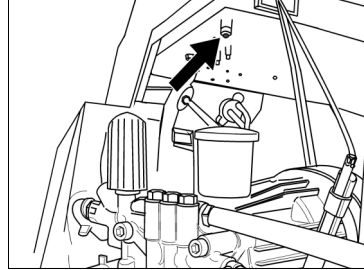

Contents

Environmental protection	24
Unit illustration	25
Operating controls	25
Reference to operating instructions	26
Commissioning	26
Operation	28
After every operation	31
Decommissioning	32
Maintenance	32
Maintenance tasks	32
Faults	33
Warranty	35
General notes	36
EC conformity declaration	37
Technical data	38
Parts list	405



Danger: Steam!

Danger of scalding! Steam escapes here.



Warning!

Prior to initial operation it is mandatory to read the operating instructions and the notes on safety no. 5.951-949!

Inform retailer immediately of any transportation damage.

Environmental protection

Please dispose of packaging environmentally responsibly



The packaging materials are recyclable. Please do not throw the packaging in with household rubbish but take it to a recycling centre.

Please dispose of scrapped units environmentally-responsibly



Scrapped units consist of valuable recyclable materials that should be taken to a recycling centre. Batteries, oil and similar products must not be allowed to contaminate the environment. Therefore, please dispose of scrapped units via appropriate disposal systems.

Please ensure engine oil, fuel oil, diesel and petrol

to contaminate the environment. Please protect the ground and dispose of used oil ecologically.

Unit illustration

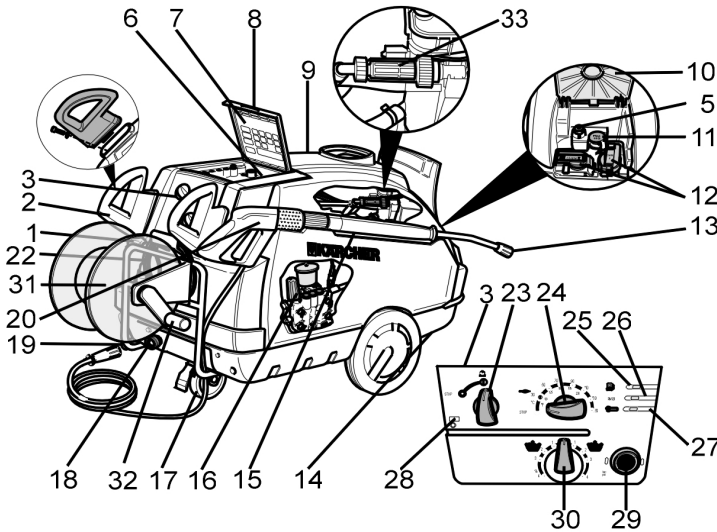

Operating controls

- | | |
|---|--|
| <ul style="list-style-type: none"> 1 Fuel tank inlet 2 Handle 3 Instrument panel 5 Cover latch 6 Compartment für accessories 7 Short operating instructions 8 Cover for compartment 9 Unit cover 10 Cover for tank inlet 11 Tank inlet für scale inhibitor 12 tank inlet for cleaning agent 13 High-pressure nozzle 14 Handle grips in the chassis 15 Steel pipe 16 Pressure and flow control 17 Swivel caster with parking brake | <ul style="list-style-type: none"> 18 Water connection with strainer 19 High-pressure connection 20 Handgun with high-pressure hose 22 Electric power cord 23 Unit switch 24 Temperature regulator 25 Fuel indicator lamp 26 Scale inhibitor indicator lamp 27 Motor indicator lamp (not applicabt to HDS Super M Eco/HDS Super MX Eco) 28 Ready for working indicator lamp 29 Pressure gauge 30 Metering valve for cleaning agent 31 Hose reel (applies only to MX / SX Eco) 32 Crank (applies only to MX / SX Eco) 33 Fine filter |
|---|--|

Reference to operating instructions

All of the item numbers described below in the operating instructions are referenced in the illustration of the unit.

Commissioning



Warning!

Unit, piping, high-pressure hose and connections must be in perfect working order!

- Lock the hand brake.

Checking oil level

Fig. 1



Warning!

Immediately consult the Kärcher service station when oil turns milky!

- If oil level is approaching MIN mark, fill up with oil as far as MAX mark.
- Seal oil filler inlet.

Refer to technical data for oil grade.

Filling with scale inhibitor

Fig. 2

(sample pack included with scope of delivery)

Scale inhibitor stops heating coil becoming calcified when using hard tap water. Is metered in at the inlet in the water reservoir one drop at a time.

By the manufacturer metering is set to a mean water hardness.

- For other water hardnesses request services of a Kärcher service station and have it adapted to local conditions.

Filling with fuel



Warning!

Never operate unit with fuel tank empty! Fuel pump would otherwise be destroyed!



Warning!

Fig. 3

Only fill with diesel fuel or light fuel oil. It is forbidden to use unsuitable fuels, e.g. benzine (explosion hazard, damage to unit).

- Close tank cap
- Wipe off excess fuel



Fill with cleaning agent

- Use only Kärcher products.
- Never pour in solvent (petrol, acetone, thinner etc.)!
- Avoid contact with eyes and skin
- Pay attention to cleaning-agent manufacturer's instructions on safety and handling

Kärcher offers a customised cleaning and care agent range.

Your dealer will be pleased to advise you.

Fig. 4

Fill with cleaning agent

Installing the handgun (units without hose reel)

- Connect steel pipe (item 15) with handgun (item 20)
- Insert high-pressure nozzle in union nut
- Mount and tighten unit nut
- Install the high-pressure hose to high-pressure connection of unit. (Figure 6a)

Installing the handgun and the hose reel (units with hose reel)

- Connect steel pipe (item 15) with handgun (item 20)
- Insert high-pressure nozzle in union nut
- Mount and tighten unit nut
- Install the hose reel (item 31) with the provided Allen screws, washers and nuts (4 of each). (Figure 5)
- Install the high-pressure hose at the high-pressure connection of hose reel and unit. (Figure 6b)
- Connect high-pressure hose of handgun to hose reel
- Wind high-pressure hose onto hose reel with the smallest possible bends (direction of turns – clockwise -)

Mounting of spare high-pressure hose

Fig. 7

Mounting handle

Fig. 8

Water connection

- See Technical Data for connected loads.
- Install supply hose at water connection (item 18) of unit.
(supply hose is not part of scope of delivery)

Drawing in water from tank

When you suction water out of an open container you should

- remove water connection at pump head.
- screw off the top supply hose with the fine filter to the water tank and connect to pump head.
- Use a water suction hose with a suction filter and a diameter of at least 3/4".

Until the pump sucks up water you should:

- Turn the pressure and flow control to "MAX".
- close the metering valve for the cleaning agent.



Warning!

Never suction up water out of a potable water tank.

Never suction up solvent-bearing liquids such as paint thinner, benzene, oil or unfiltered water. The seals in the unit are not resistant to solvents. The mist of solvents is highly inflammable, explosive and poisonous!

Mains connection

See technical data and rating plate for connected load.



Warning!

It is not permissible to exceed the maximum permissible mains impedance at the electrical terminal (see Technical Data).



Warning!

Whenever socket is changed, check direction of rotation of motor

- If direction of rotation is correct, powerful jet of air will be felt at exhaust-gas opening of burner.
- If the direction of rotation is wrong: Change the poles at the unit plug. See Fig. 18.
- When an extension cable is used it should always be completely unwound and have an adequate cross-section.

Operation



Warning!

*(Applies only to HDS Super M / MX Eco)
Lengthy operation of the unit can lead to vibration-related circulatory disturbances of the hands.*

A generally valid use duration cannot be specified, since this is dependent upon several influence factors:

- Personal predisposition to bad circulation (frequent suffering from cold fingers, pins and needles in fingers).
- In low ambient temperatures. Wear warm gloves to keep hands warm.
- Gripping tightly impedes circulation.

- Continuous operation is more detrimental than operation interrupted by breaks.

We recommend a medical examination if the unit is regularly used for extensive, continuous operation and the corresponding symptoms (such as, for example, pins and needles in fingers or cold fingers) are recurrent.

Switch on the machine

- Set unit switch (item 23) to "I"
Ready for working indicator lamp (item 28) is lit



Warning!

The temperature regulator (item 24) must be set to "0", since otherwise the burner possibly switches on

Unit starts up briefly and is switched off as soon as operating pressure is reached.

Stop the unit immediately when one of the indicator lamps (items 25-27) light up during operation. Eliminate fault, refer to Faults.

Fig. 9

- Release the safety of the handgun (A)
Actuation of handgun switches unit back on again.

Bleed pump if no water emerges from high-pressure nozzle. See problems, "Unit does not build up pressure"

Setting cleaning temperature

- Set the temperature regulator (item 24) to the required temperature

30°C to 90°C
Hot water cleaning

100°C to 150°C
Cleaning with steam

- Replace high-pressure nozzle by the steam nozzle (see operation using steam)

Setting operating pressure and flow rate

Fig. 10

- Turning control spindle clockwise: Increasing operating pressure (MAX)
- Turning it counterclockwise: Reducing operating pressure (MIN)

Servopress control

- Set the temperature regulator (item 24) to max. 98°C.
- Set regulator to maximum operating pressure.

Fig. 9

Adjust operating pressure and flow rate by turning (infinitely variable) at the pressure and flow control (B) (+/-)

Set pressure on unit if use is to be made of reduced pressure for a lengthy period.

See Fig. 10

Measuring out cleaning agents

- Use cleaning agents sparingly to protect the environment
- The cleaning agent must be appropriate for the surface to be cleaned.
- Using the cleaning agent metering valve (item 30) set the concentration of the cleaning agent as specified by the manufacturer

Approximate values at maximum operating pressure

Intended use

For cleaning: machines, vehicles, buildings, tools, facades, patios, gardening implements, etc.



Warning!

- Heed appropriate safety regulations for use at petrol stations or in other hazardous environments.

Please ensure waste water containing mineral oil

does not contaminate soil, lakes and rivers or the sewerage system. Therefore, please wash engines and underbodies only in appropriate washing installations provided with oil traps.

Working with high-pressure nozzle

Spray angle is crucial to efficiency of high-pressure jet.

Use is normally made of 25° fan jet nozzle (included).

Recommended nozzles, available as accessories

- For stubborn dirt
0°full jet nozzle
- For sensitive surfaces and superficial dirt
40°-fan jet nozzle
- For thick-film, stubborn dirt
Dirt blaster
- Nozzle with adjustable spray angle, adaptable to many cleaning tasks
Variable-angle nozzle

Cleaning

- Set pressure/temperature and detergent concentration appropriately to surface to be cleaned

Always start by directing high-pressure jet from a good distance at object to be cleaned to avoid damage caused by excessive pressure.

Recommended cleaning method

Loosen up dirt:

- Spray on cleaning agent sparingly and allow to react for 1...5 min (do not allow to dry on).

Remove dirt:

- Spray off loosened-up dirt with high-pressure jet.

Operation with cold water

Removal of slight contamination and rinsing e.g: gardening implements, patio, tools, etc.

- Set operating pressure as required
- Set temperature control (item 24) to "0"

Operation with hot water



Warning!

Danger of scalding

- Set the temperature regulator (item 24) to the required temperature

We recommend the following cleaning temperatures

- Slight contamination 30-50°C
- Protein soiling, e.g. in foodstuffs industry max. 60°C
- Motor vehicle cleaning, machine cleaning 60-90°C

Operation with steam



Danger: Steam!

At operating temperatures exceeding 98°C it is not permissible for the operating pressure to exceed 32 bar (HDS 1195: 28 bar).

Therefore the following steps must be taken without fail:

- Replace high-pressure nozzle by steam nozzle

Manufacture no.:

4.766-023	HDS Super M Eco
	HDS Super MX Eco
	HDS 655 M Eco
	HDS 695 M Eco
	HDS 695 MX Eco
	HDS 895 M Eco
	HDS 895 MX Eco
4.766-024	HDS 1195 S Eco
	HDS 1195 SX Eco

- Fully open water delivery control at the handgun, in the + direction to the stop. See Figure 9 (B)
- Set operating pressure to minimum value. See Fig. 10
- Set the temperature regulator (item 24) to min. 100°C



Danger: Steam!

Danger of scalding!

We recommend the following cleaning temperatures

- Preservative removal, extremely greasy dirt 100-110°C
- Thawing of aggregates, certain facade cleaning operations up to 140°C

After every operation



Warning!

Danger of scalding with hot water.

After operating it with hot water or steam the unit must be cooled for at least two minutes by operating it with cold water and its open handgun.

Following operation with cleaning agent

- Set cleaning agent metering valve (item 30) to "0"
- Set unit switch (item 23) to "I"
- Actuate handgun and flush unit for approx. 1 min

Stopping machine

- Set unit switch (item 23) to "0"
- Shut off water supply
- Switch the pump briefly on with the unit switch (item 23) (approx. 5 sec.)
- Remove mains plug from socket ONLY with dry hands
- Remove water connection
- Actuate handgun to depressurise unit
- Put on safety of handgun Figure 9 (A)
- Engage spray lance in cover holder
- Reel up the high-pressure hose and electric cables and attach them to fastenings

Note!

Take care not to kink high-pressure hose and cable!

Note!

Frost will destroy unit if water is not drained off completely!

- Store unit in a frost-free location

Observe the following if the unit is connected to a flue:

Danger of damage caused by cold air entering through the flue. Disconnect unit from flue at outside temperatures below 0°C.

Immobilise unit if frost-proof storage is not possible.

Decommissioning

In the event of lengthy periods of non-use or if frost-free storage is not possible:

- Drain off water and flush out equipment with antifreeze
- Drain cleaning fluid tank

Drain off water

- Unscrew water supply hose and high-pressure hose
- Screw off supply line at boiler base and completely drain heating coil
- Run unit for max. 1 min until pump and lines are empty

Flushing unit with anti-freeze

- Fill the float tank with a commercially available antifreezing compound
- Switch the unit on (without the burner) until it is thoroughly purged
- Observe handling instructions of antifreeze manufacturer

By this means, a certain degree of corrosion protection is achieved

Maintenance



Warning!

Disconnect unit from mains before carrying out any maintenance or repair work. Always use genuine spare parts

Turn off unit prior to all work, see "After every operation".

- Set unit switch (item 23) to "0"
- Pull power plug out of socket
- Shut off water supply
- Actuate handgun to depressurise unit.
- Remove water connection
- Allow unit to cool down

Your Kärcher dealer will be pleased to inform you on the performance of regular safety inspections and conclusion of a maintenance contract

Maintenance intervals

Once a week

- Clean strainer in water connection
- Clean the fine filter
- Check oil level

Immediately consult the Kärcher service station when oil turns milky!

Once a month

- Clean strainer in low water protection
- Clean filter at cleaning-agent suction hose

After 500 hours of operation, at least once a year

- Change oil

Maintenance tasks

Clean strainer in water connection

Fig. 11

- Remove strainer
- Clean in water and re-insert

Clean the fine filter

Fig. 12

- Cut pressure to unit
- Screw off cover with filter
- Clean filter with clean water or with compressed air
- Assemble in the reverse order

Clean strainer in low water protection

Fig. 13

- Unfasten union nut and detach hose

Fig. 14

- Take out strainer
- If necessary, screw in screw M8 by approx. 5mm and pull strainer out with this screw*

- Clean strainer in water
- Slide in strainer
- Mount hose
- Tighten union nut

Clean filter at cleaning-agent suction hose

Fig. 15

- Pull the cleaning agent suction inlet pipe out
- Clean filter in water and re-insert

Change oil

Fig. 16

- Provide a collecting container for approx. 1 litres of oil
- Unscrew drain plug

Dispose of used oil ecologically or hand it in at a dump.

- Retighten drain plug
 - Top up oil slowly up to the MAX mark
- Air bubbles must be able to escape*
Refer to technical data for oil grade and quantity to be used.

Faults

Ready for working indicator lamp (item 28) goes out

- Motor overloaded/overheated
- Set selector switch to "0" and allow engine to cool off for at least 5 min.
- Have unit checked by After-Sales Service if this does not remedy fault.
- No mains voltage (see – unit does not run -)
- Check exhaust gas temperature limiter, reset, if necessary (Figure 19) (applies only to HDS Super M / MX Eco)

Fuel indicator lamp (item 25) lights up

- Fuel tank empty
- Fill up

Liquid softener indicator lamp (item 26) lights up

- Scale inhibitor reservoir empty; for technical reasons there is always a residual quantity in the reservoir.
- Fill up

- Dirt on electrodes in reservoir
- Clean electrodes

Motor indicator lamp (item 27) lights up

- Set unit switch (item 23) to "0"
- Allow unit to cool down
- Check exhaust gas temperature limiter, reset, if necessary (Figure 19)
- Set unit switch (item 23) to "I"

Unit does not run

- No mains voltage
- Check electric mains/power cord

Unit does not build up pressure

— Air in system

Bleed pump:

- Set cleaning agent metering valve (item 30) to "0"
- Switch the unit switch on and off several times keeping the handgun open.
- With handgun open, open and close regulator (Fig. 10).

Venting is accelerated by removing the high-pressure hose from the high-pressure connection.

- Fill up cleaning-agent tank if empty.
 - Check connections and lines
- Pressure set to MIN
- Set pressure to MAX
- Strainer in water connection is dirty
- Clean strainer
 - Clean fine filter, replace it if necessary
- Insufficient water supply
- Check water supply volume (refer to technical data)

Unit leaking, water dripping out at bottom

— Pump leaking

3 droplets/min are permitted.

- In the event of a major leak, have unit checked by After-Sales Service.

Unit constantly switched on and off with handgun closed

— Leak in high-pressure system

- Check high-pressure system and connections for leaks

Unit does not draw in cleaning agent

- Run the unit with an opened cleaning agent metering valve and a closed water supply until the float tank is sucked dry and the pressure drops to "0".
- Now reopen the water inlet.

If the pump still does not suction up cleaning agent the reasons can be as follows:

- Filter in cleaning-agent suction hose dirty
- Clean filter

— Non-return valve gummed up

- Pull the cleaning agent hose off and detach the non-return valve with a blunt object, see Figure 17.

Burner not ignited

— Fuel tank empty

- Fill up

— Lack of water

- Check water connection, check supply, clean low water protection.

— Fuel filter is dirty

- Replace fuel filter.

— Incorrect direction of rotation. If direction of rotation is correct, powerful jet of air will be felt at exhaust-gas opening of burner.

- Check direction of rotation. If necessary, change round poles of unit plug. See Fig. 18.

— No ignition spark

- Have unit checked by After-Sales Service if no ignition spark is visible through inspection glass during operation.

Set temperature not attained when working with hot water

- Excessive operating pressure/flow rate
- Reduce operating pressure/flow rate by way of regulator (Fig. 10)

- Soot deposits on heating coil
- Have After-Sales Service remove soot deposits from unit

The unit must be checked by after sales service if the problem cannot be remedied.

Warranty

The warranty terms and conditions issued by our responsible sales company apply in every country. Within the warranty period, any faults in the unit will be rectified free of charge provided that the problem was caused by a material defect or manufacturing error.

The warranty only applies if the dealer fills in, stamps and signs the enclosed reply card when the unit is sold and the purchaser then returns it to the appropriate local distributor.

In the event of a warranty claim, please contact your dealer or the nearest authorised After-Sales Service office and produce both accessories and proof of purchase.

General notes

Safety features

Overflow valve with two pressure switches

- When reducing water volume at pump head or with the servopress control, the overflow valve will open and part of the water will flow back to the pump suction side.
- If the handgun is closed off so that all the water flows back to the pump suction side, the pressure switch at the overflow valve turns off the pump.
- Reopening the handgun causes the pressure switch at the cylinder head to switch the pump back on again.

The overflow valve is set at the factory and lead-sealed. Adjustment can only be made by After-Sales Service.

Safety valve

- The safety valve opens if the overflow valve or pressure switch is defective.

The safety valve is set at the factory and sealed. Adjustment can only be made by After-Sales Service.

Low water protection

- The low water protection prevents the burner switching on when water is insufficient.
- A strainer prevents dirt accumulation on the protection and must be regularly cleaned.

Motor protection switch

- The motor protection switch interrupts the circuit should overloading occur.

Switching on procedures

- Switching on procedures generate brief voltage drops.
- Impairments of other appliances can occur in cases of unfavourable mains conditions.
- No problems are to be expected with a mains impedance of less than 0,15 ohm.

EC conformity declaration

We hereby declare that the machine specified below as the marketed design, the machine specified below complies with the relevant fundamental safety and health requirements of the EC directives listed below.

Modification of the machine without our approval invalidates this declaration.

Product: High-pressure cleaner
with a steam stage

Type: 1.025-xxx, 1.026-xxx, 1.027-xxx,
1.028-xxx

Relevant EC directives

EC machine directive (98/37/EC)
EC low voltage directive (73/23/EEC)
amended by 93/68/EEC
EC directive on electromagnetic
compatibility (89/336/EEC) amended by
91/263/EEC, 92/31/EEC, 93/68/EEC
EC high-pressure equipment directive
(97/23/EG)
EC guideline on noise emissions
(2000/14/EU)

Applied harmonised standards

DIN EN 60335-1
DIN EN 60335-2-79
DIN EN 55014-1:2000 + A1:2001
DIN EN 55014-2:1997
DIN EN 61000-3-2:2000
DIN EN 61000-3-3:1995 + A1:2001
(HDS 695 / HDS 895)
DIN EN 61000-3-11:2000
(HDS 655 / HDS 1195 / HDS Super)

Applied national standards

--

Applied conformity valuation method

Appendix V

Measured sound power level:

HDS 655	85 dB(A)
HDS 695	88 dB(A)
HDS 895	89 dB(A)
HDS 1195	88 dB(A)
HDS Super	95 dB(A)

Guaranteed sound power level:

HDS 655	87 dB(A)
HDS 695	89 dB(A)
HDS 895	91 dB(A)
HDS 1195	89 dB(A)
HDS Super	96 dB(A)

Internal measures ensure that the in series produced units always comply with the requirements of current EC directives and applied standards. The signatories act for and in authority of management.

5.957-649 (02/04)

Alfred Kärcher Limited Partnership.
Registered office: Winnenden. Registration
court: Waiblingen, HRA 169.
Personally liable partner. Kärcher
Reinigungstechnik GmbH. Registered
office Winnenden, 2404 Waiblingen
Company Register, HRB

Managing directors:
Dr. Bernhard Graf, Hartmut Jenner,
Georg Metz

Alfred Kärcher GmbH & Co. KG
Cleaning Systems
Alfred-Kärcher-Strasse 28-40
P.O.Box 160
D-71349 Winnenden
Phone: ++49 7195 14-0
Fax :++49 7195 14-2212

(Reiser)

(Jenner)

Type	HDS Super M / MX Eco		HDS 655 M Eco	
Mains connection	400 V	230 V	230 V	230 V
Connected load	3~50 Hz	3~50 Hz	1~50 Hz	1~60 Hz
Fuse (slow blow)	6,4 kW	6,4 kW	3,2 kW	3,2 kW
Maximum permissible mains impedance	16 A	25 A	16 A	16 A
	(0,307+j 0,192) Ω	(0,307+j 0,192) Ω	(0,294+j 0,184) Ω	(0,294+j 0,184) Ω
Water connection	max. 30 °C			
Supply temperature	min. 1200 l/h (20 l/min)			
Supply volume	0,5 m			
Suction height when drawn from open tank (at 20 °C water temperature)	0,5 m			
Performance data	450-900 l/h (7.5-15 l/min)			
Flow rate: cold/hot water	3-18 MPa (30-180 bar)			
Operating pressure: cold/hot water (with standard nozzle supplied)	450 l/h (6,7 l/min)			
Flow rate: steam	max. 3,2 MPa (32 bar)			
Operating pressure: steam	4,766-023			
Steam nozzle part number	max. 95 °C			
Operating temperature	98-155 °C			
- Hot water	0 - 35 l/h (0-0,6 l/min)			
- Steam	77 kW			
Cleaning-agent intake	6,3 kg/h			
Burner output	32 N			
Maximum fuel oil consumption	79 dB (A)			
Recoil force of handgun	96 dB (A)			
Noise emission	2,6 m/s ²			
Sound pressure level (EN 60704-1)	2,3 m/s ²			
Guaranteed sound power level (2000/14/IEC)	Fuel oil EL or diesel			
Machine vibration	0,6 l			
Rated vibration value (ISO 5349)	Hypold SAE90 (6.288-016)			
Handgun	1285x690x835 mm			
Spray lance	133 kg			
Fuels	141 kg			
Fuel	25 l			
Oil quantity	20 l			
Oil grade	Fuel tank			
	Cleaning-agent tank			
Dimensions and weights	1285x690x835 mm			
Length x Width x Height	130 kg			
Weight not incl. accessories	-			
Weight not incl. accessories, MX Eco	25 l			
Fuel tank	20 l			
Cleaning-agent tank	20 l			

Type	HDS 695 M / MX Eco		HDS 895 M / MX Eco	
Mains connection	230 V	400 V	230 V	380 V
Connected load	3-50 Hz	3-50 Hz	3-60 Hz	3-50 Hz
Fuse (slow blow)	5,8 kW	5,8 kW	6,8 kW	6,8 kW
Maximum permissible mains impedance	25 A	16 A	25 A	16 A
Water connection	max. 30 °C			
Supply temperature	min. 1000 l/h (16,7 l/min)			
Supply volume	0,5 m			
Suction height when drawn from open tank (at 20 °C water temperature)	0,5 m			
Performance data	470-1000 l/h (7,8-16,7 l/min)			
Flow rate: cold/hot water	3-18 MPa (30-180 bar)			
Operating pressure: cold/hot water (with standard nozzle supplied)	470 l/h (7,8 l/min)			
Flow rate: steam	max. 3,2 MPa (32 bar)			
Operating pressure: steam	4,766-023			
Steam nozzle part number	max. 95 °C			
Operating temperature	98-155 °C			
- Hot water	0 - 32 l/h (0-0,5 l/min)			
- Steam	69 kW			
Cleaning-agent intake	5,6 kg/h			
Burner output	32 N			
Maximum fuel oil consumption	73 dB (A)			
Recoil force of handgun	89 dB (A)			
Noise emission	1,4 m/s ²			
Sound pressure level (EN 60704-1)	0,8 m/s ²			
Guaranteed sound power level (2000/14/IEC)	Fuel oil EL or diesel			
Machine vibration	0,75 l			
Rated vibration value (ISO 5349)	Hypold SAE90 (6.288-016)			
Handgun	1285x690x835 mm			
Spray lance	130 kg			
Fuels	138 kg			
Fuel	25 l			
Oil quantity	20 l			
Oil grade	20 l			
Dimensions and weights	Fuel tank			
Length x Width x Height	Cleaning-agent tank			
Weight not incl. accessories	133 kg			
Weight not incl. accessories, MX Eco	141 kg			
Fuel tank	25 l			
Cleaning-agent tank	20 l			

Type	HDS 1195 S / SX Eco		
Mains connection	400 V 3~ 50 Hz 8,2 kW 16 A (0,307+ 0,192) Ω	230 V 3~ 50 Hz 8,2 kW 35 A (0,307+ 0,192) Ω	230 V 3~ 60 Hz 8,2 kW 35 A (0,307+ 0,192) Ω
Connected load			380 V 3~ 50 Hz 8,2 kW 16 A
Fuse (slow blow)			
Maximum permissible mains impedance			(0,307+ 0,192) Ω
Water connection			
Supply temperature	max. 30 °C		
Supply volume	min. 1500 l/h (25 l/min)		
Suction height when drawn from open tank (at 20 °C water temperature)	0,5 m		
Performance data			
Flow rate: cold/hot water	600-1200 l/h (10-20 l/min)		
Operating pressure: cold/hot water (with standard nozzle supplied)	3-18 MPa (30-180 bar)		
Flow rate: steam	600 l/h (10 l/min)		
Operating pressure: steam	max. 2,8 MPa (28 bar)		
Steam nozzle part number	4,766-024		
Operating temperature			
- Hot water	max. 95 °C		
- Steam	98-155 °C		
Cleaning-agent intake	0 - 48 l/h (0-0,8 l/min)		
Burner output	103 kW		
Maximum fuel oil consumption	8,3 kg/h		
Recoil force of handgun	60 N		
Noise emission			
Sound pressure level (EN 60704-1)	73 dB (A)		
Guaranteed sound power level (2000/14/EC)	89 dB (A)		
Machine vibration			
Rated vibration value (ISO 5349)	2,5 m/s ²		
Handgun	2,3 m/s ²		
Spray lance			
Fuels			
Fuel	Fuel oil EL or diesel		
Oil quantity	0,75 l		
Oil grade	Hypoid SAE90 (6.288-016)		
Dimensions and weights			
Length x Width x Height	1285x690x875 mm		
Weight not incl. accessories	155 kg		
Weight not incl. accessories, SX Eco	163 kg		
Fuel tank	25 l		
Cleaning-agent tank	20 + 17 l		

