

Food Special SET

Choose your hose assemblies with the ST-3225 linear food gun and automatic hose reel



The choice of perfection

The ideal spray gun for the food industry
- high flow
- light weight

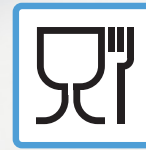

Made out of plastics intended to come into contact with foodstuffs according to Regulation (EC) No. 1935/2004.

Suitable for the food industry



Smooth cover:
easy handling with best sliding characteristics

The professional flat spray gun ST-3225 for the food industry

- low pressure and high pressure version available
- especially designed for highest requirements to hygiene and ergonomics, stainless steel version
- extremely light with a weight of 745 gramms
- made out of plastics intended to come into contact with foodstuffs according to Regulation (EC) No. 1935/2004
- suitable for a high flow of 120 l/min.
- the low pressure version has a locking in opened position
- LTF technology: 90 % reduced holding force and 40 % reduced trigger force against usual market guns
- opening and holding force at 60 bar and 28 l/min.: 21.10 N
- very low pressure drop (at 85 l/min.: 3.60 bar)
- low pressure and high pressure version available: 24,5 bar / 60 bar



LTF

The PReClean365+® 40 high pressure food hose with stainless steel fittings: AGR 1/2"

- Especially developed to meet highest requirements to hygiene and ergonomics
- Smooth, stain and grease resistant, surface
- Surface made out of thermoplastic elastomer, fabric inlay of synthetic fibre and PES, **available in 4 colors (HACCP)**. Increased 1-layer rot-proof textile mesh
- Conform to EG-regulation Nr. 1935/2004 nd Nr. 10/2011. Developed for industrial foaming in the food industry.
- **Field of application:** foam hose and pre-spraying hose in the food industry. Suitable for contact with liquid food products
- **Suitable** for water and water mixes of usual cleaning detergents
- **About 20 % lighter and more flexible than comparable hose types**
- 45 bar workingpressure at 70° C



Version: 30.06.2020

www.rm-suttner.com

Food Special SET

Hygienic colour variety in a SET: PUREClean365+® 40 food hoses with the professional flat ST-3225



The choice of perfection

Food Special SET

Professional ST-3225 gun with progressive closing system and coupling ST-3100. Inlet 1/2" F swivel.

Stainless steel. Max. 24.5 bar or 60 bar. Max. 120 l/min / 100 °C.

with PUREClean365+ 40 food hose 1/2" male thread AGR. 45 bar working pressure at 70 °C

ST-3225 / PUREClean365+ 40 blue



R+M Nr.	gun (P)	length
476 046 620 91	24.5 bar	20 m
476 046 625 91	24.5 bar	25 m
476 046 630 91	24.5 bar	30 m
476 046 620 92	60 bar	20 m
476 046 625 92	60 bar	25 m
476 046 630 92	60 bar	30 m

ST-3225 / PUREClean365+ 40 yellow



R+M Nr.	gun (P)	length
476 346 420 91	24.5 bar	20 m
476 346 425 91	24.5 bar	25 m
476 346 430 91	24.5 bar	30 m
476 346 420 92	60 bar	20 m
476 346 425 92	60 bar	25 m
476 346 430 92	60 bar	30 m

ST-3225 / PUREClean365+ 40 green



R+M Nr.	gun (P)	length
476 446 220 91	24.5 bar	20 m
476 446 225 91	24.5 bar	25 m
476 446 230 91	24.5 bar	30 m
476 446 220 92	60 bar	20 m
476 446 225 92	60 bar	25 m
476 446 230 92	60 bar	30 m

ST-3225 / PUREClean365+ 40 red



R+M Nr.	gun (P)	length
476 246 720 91	24.5 bar	20 m
476 246 725 91	24.5 bar	25 m
476 246 730 91	24.5 bar	30 m
476 246 720 92	60 bar	20 m
476 246 725 92	60 bar	25 m
476 246 730 92	60 bar	30 m

HACCP R+M / Suttner's hygienic colour-coding concept

Suttner's color-coded concept provides a pragmatic approach to the food sector's challenges of ensuring efficient hygienic cleaning and a visibly safe physical environment in:

- » Food and beverage manufacturing facilities and throughout their supply chain
- » Professional kitchens and restaurants
- » Food-related areas of supermarkets and shops

Durable and effective accessories

All of R+M/Suttner's food-industry specific 'high hygiene' tools are made of 1935/2004/EC compliant materials and materials which meet the requirements of EC regulation 10/2011/EC regarding food contact materials and can be washed at high temperatures to eliminate germs and bacteria.

All equipment is durable, fully molded to guarantee easy cleaning and capable of maintaining a long-lasting attractive appearance.

The effective tool range includes spray and foam guns, spray lances, nozzle protectors, foam lances and hoses in up to four color-code options.

Technical data professional spray gun ST-3225

spray gun	ST-3225 HP	ST-3225 LP
max. pressure	60 bar 870 psi	24.5 bar 355 psi
max. flow	120 l/min / 31.5 gpm	
max. temperature	100 °C	
Inlet rear	1/2" F swivel	
outlet	coupling ST-3100	
chemical resistance	high	
LTF technology	standard	
Material valve housing	stainless steel	
Material valve	PTFE / stainless steel	
Private Label	optional	

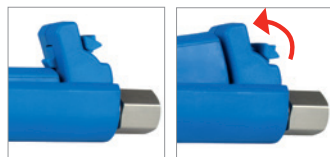

Locked: the 24.5 bar low pressure spray gun ST-3225 can also be locked in opened position.



ST-3225-ergonomics:
flat, light design for well-directed and safe handling

Technical data PUREClean365+® 40

	(P)		(BP)	
°C	20	70	20	70
bar	100	45	=>250	110
DN	⊙		⊙	
	+/- mm		+/- mm	
	inch	mm	inch	mm
12	0.49	12.5	0.3	0.85
	⊙		⊙	
	mm		mm	
	kg/m		mm	
	0.3		4.5	



with stainless steel fittings 1/2" AGR

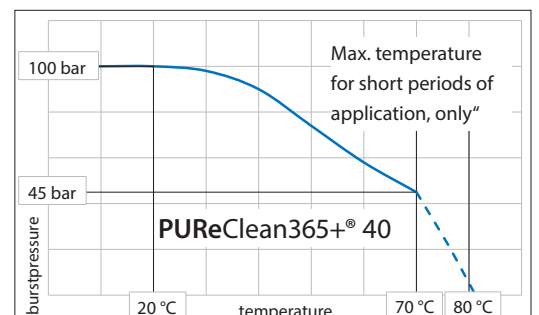

Food Special SET

Hygienic colour variety in a SET:

PUReClean365 +[®] 40 food hoses and automatic high pressure hose reels, rustproof with or without linear food gun ST-3225



The choice of perfection

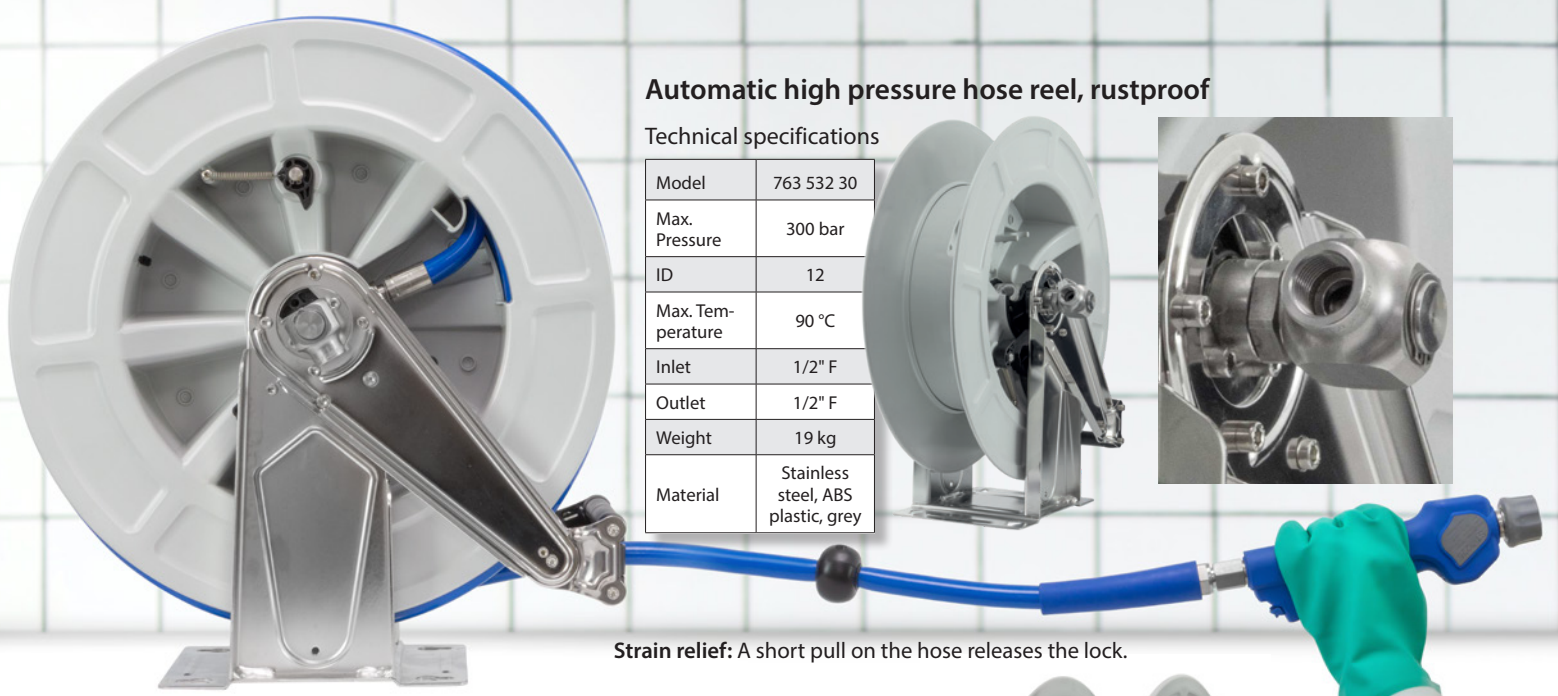

Automatic high pressure hose reel, rustproof

Technical specifications

Model	763 532 30
Max. Pressure	300 bar
ID	12
Max. Temperature	90 °C
Inlet	1/2" F
Outlet	1/2" F
Weight	19 kg
Material	Stainless steel, ABS plastic, grey

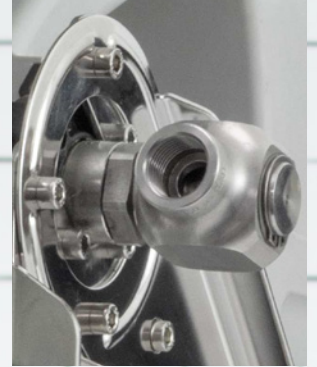
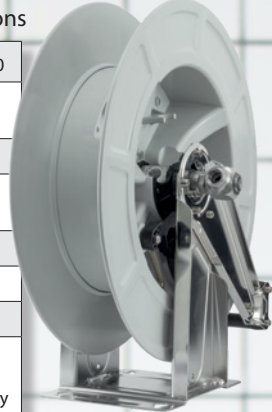

Strain relief: A short pull on the hose releases the lock.

- Frame made of **stainless steel V2A / AISI 304**. Drum made of particularly impact-resistant ABS plastic.
- The high-quality construction of the automatic high-pressure hose reel with automatic spring return.
- Easy installation on walls, ceilings, vehicles.
- All models have a strain relief.
- Equipped with the high-quality Suttner swivel joint ST-322.
- Max. pressure: 300 bar, max. temperature: 90 °C
- Applicable media: water or water with cleaning chemicals, air, oils and greases. and air.



Sturdy material: Typically used in motorcycle helmets and in the automotive industry.

Accessories: The hose reel can be easily installed with a wall bracket or mounting plate.

Wall swivel brackets



Stainless steel V2A / AISI 304. 80° swivel

R+M Nr.	763 530 06
----------------	------------

Wall bracket



Stainless steel. Optionally as fit-up aid

R+M Nr.	763 530 02
----------------	------------

Swivel joint ST-322: Made of stainless steel, with a sliding ring sealing element.



DN 12. Max. 300 bar / 90 °C

R+M Nr.	200 322 523
height	79,5 mm



Food Special SET

Hygienic colour variety in a SET:

PUReClean365 +[®] 40 food hoses and automatic high pressure hose reels, rustproof with or without linear food gun ST-3225



The choice of perfection

Especially for use in food processing companies

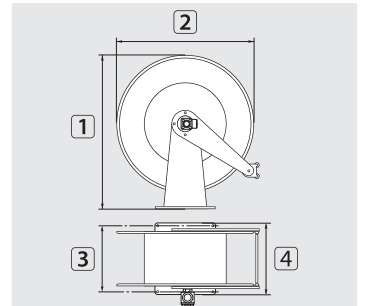
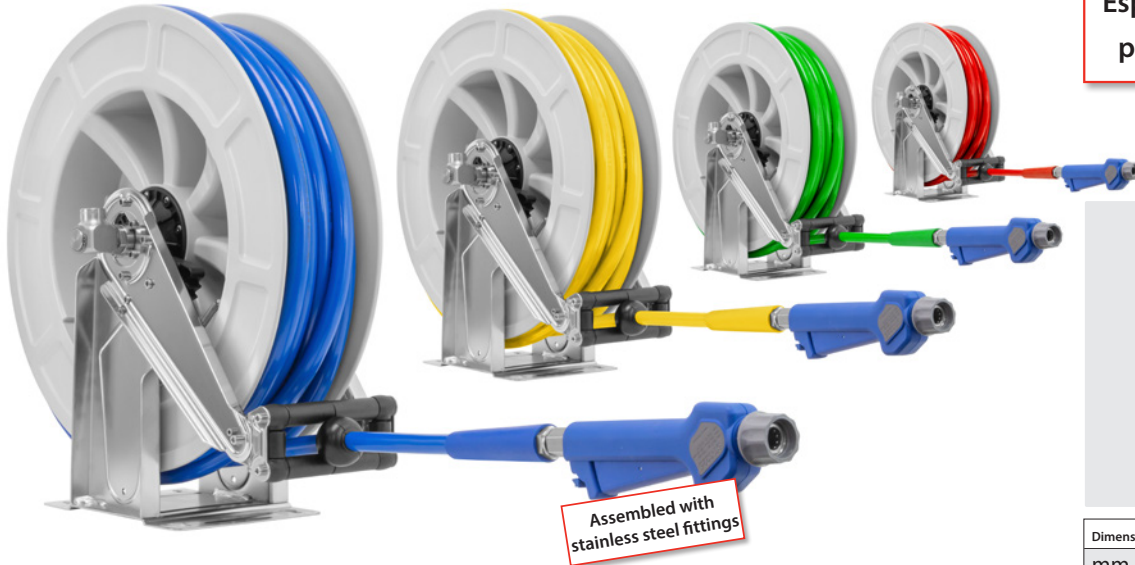

Dimensions:	1	2	3	4
mm	56	510	153	203

Automatic high-pressure hose reel, rustproof with PUReClean365 + 40 blue



R+M Nr.	length
763 532 001	24 m

Automatic high-pressure hose reel, rustproof with PUReClean365 + 40 yellow



R+M Nr.	length
763 532 003	24 m

Automatic high-pressure hose reel, rustproof with PUReClean365 + 40 green



R+M Nr.	length
763 532 004	24 m

Automatic high-pressure hose reel, rustproof with PUReClean365 + 40 red



R+M Nr.	length
763 532 002	24 m

Automatic high-pressure hose reel, rustproof with PUReClean365 + 40 blue and ST-3225



R+M Nr.	gun ^P	length
763 532 005	24,5 bar	24 m
763 532 009	60 bar	24 m

Automatic high-pressure hose reel, rustproof with PUReClean365 + 40 yellow and ST-3225



R+M Nr.	gun ^P	length
763 532 006	24,5 bar	24 m
763 532 010	60 bar	24 m

Automatic high-pressure hose reel, rustproof with PUReClean365 + 40 green and ST-3225



R+M Nr.	gun ^P	length
763 532 007	24,5 bar	24 m
763 532 011	60 bar	24 m

Automatic high-pressure hose reel, rustproof with PUReClean365 + 40 red and ST-3225



R+M Nr.	gun ^P	length
763 532 008	24,5 bar	24 m
763 532 012	60 bar	24 m