

Spare parts list

(1.516-300.0) SC 1 (yellow) *EU

Table of contents

SC 1 (yellow) *EU (1.516-300.0)	3
Short spare parts list	6
53 Point jet nozzle complete black (4.130-431.0)	8
9000 Housing complete replacement SC 1 yw (4.512-100.0)	10
9001 Housing insert complete replacement SC 1 (4.512-099.0)	11
9006 Valve complete replacement SC 1 (4.580-045.0)	13
9501 Extension hose special accessories SC 1 (2.863-021.0)	15

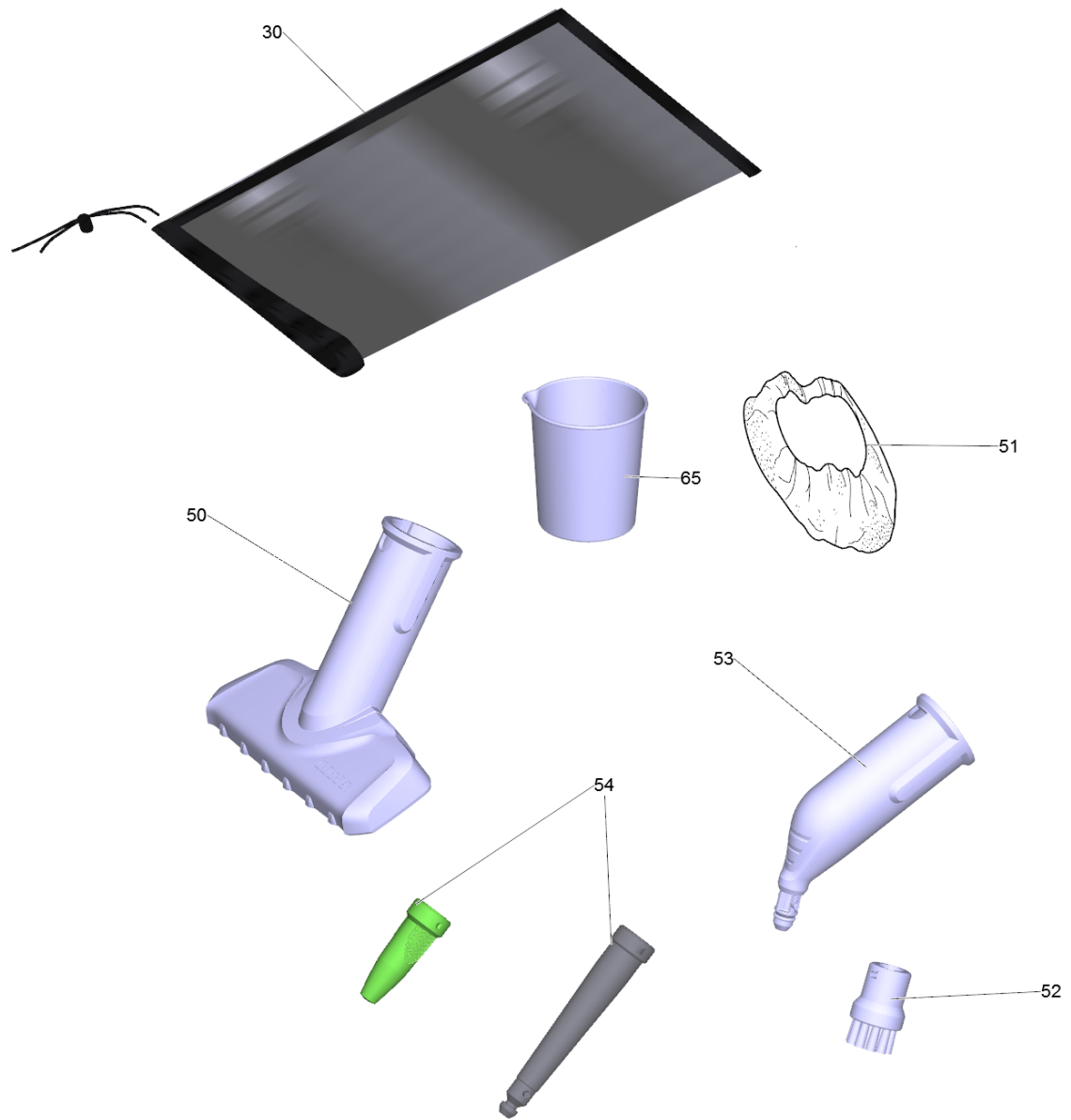

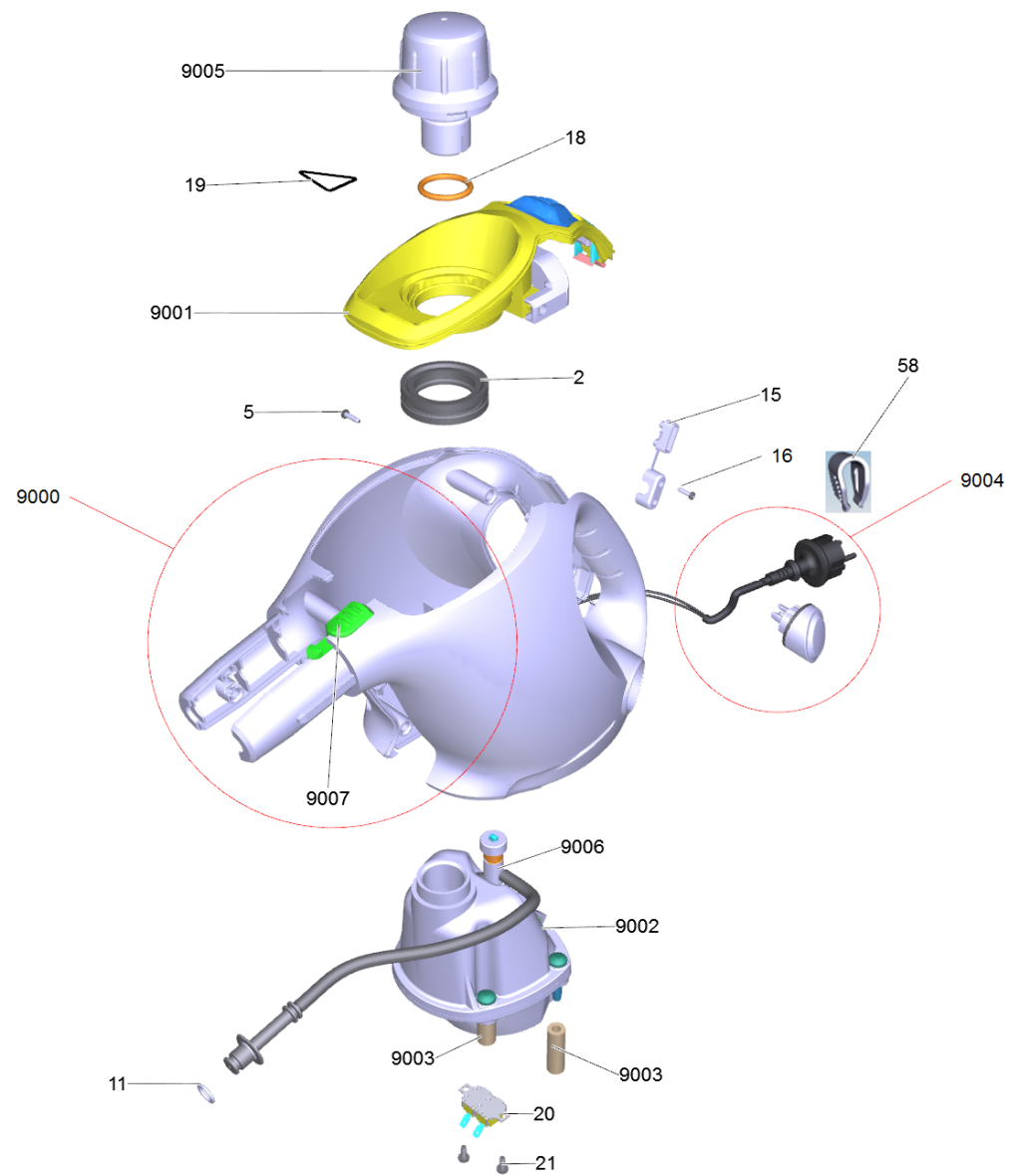

SC 1 (yellow) *EU (1.516-300.0)

POS	Article no.	Description	Quantity	Unit
9003	4.512-103.0	Bearing boiler set SC 1	1.000	ST
9002	4.070-084.0	Boiler complete replacement SC 1	1.000	ST
58	6.647-681.0	Cable clip	1.000	ST
9004	4.039-236.0	Cable set complete replacement SC 1 *EU	1.000	ST
20	6.630-649.0	Combination TR-TS Discomelt 2	1.000	ST
9501	2.863-021.0	Extension hose special accessories SC 1	1.000	ST
50	2.884-280.0	Hand nozzle	1.000	ST
15	6.373-978.0	Hat clamp strain relief	1.000	ST
9000	4.512-100.0	Housing complete replacement SC 1 yw	1.000	ST
9001	4.512-099.0	Housing insert complete replacement SC 1	1.000	ST
65	5.394-986.0	Measuring cup 200 ml, PP	1.000	ST
51	2.863-270.0	Microfibre covers for hand nozzle	1.000	ST
11	6.362-922.0	O-Ring seal 8,73x1,78	1.000	ST
18	6.363-468.0	O-Ring seal EPDM 22x3	1.000	ST
30	6.516-001.0	Pocket accessories SC 1	1.000	ST
53	4.130-431.0	Point jet nozzle complete black	1.000	ST
54	2.863-263.0	Power nozzle set	1.000	ST
52	2.863-264.0	Round brushes set	1.000	ST
9005	4.590-007.0	Safety lock replacement SC 1	1.000	ST
16	6.303-557.0	Screw 3x12 Kombitorx T8	2.000	ST
21	7.303-030.0	Screw M4x8 -St-P2R (In6Rd)	2.000	ST
5	6.303-567.0	Screw with spike 3x12 Kombitorx T8	8.000	ST
2	5.363-635.0	Seal	1.000	ST
0		Short spare parts list	1.000	ST
9007	5.037-009.0	Snap-fit SC 1	1.000	ST
9006	4.580-045.0	Valve complete replacement SC 1	1.000	ST
19	5.387-036.0	Warning sign	1.000	ST

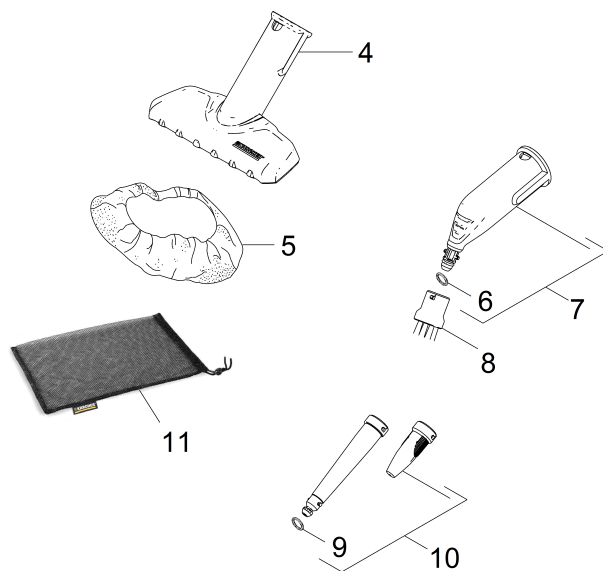
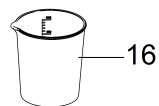
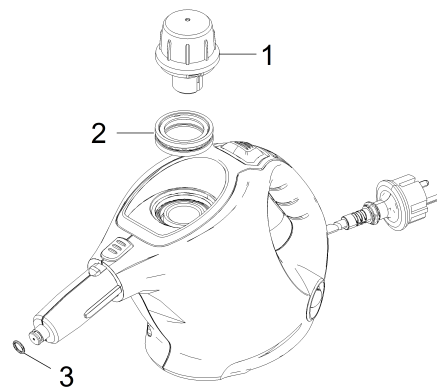

Short spare parts list

POS	Article no.	Description	Quantity	Unit
4	2.884-280.0	Hand nozzle	1.000	ST
16	5.394-986.0	Measuring cup 200 ml, PP	1.000	ST
5	2.863-270.0	Microfibre covers for hand nozzle	1.000	ST
9	6.362-924.0	O-Ring seal 6,02X 2,62	1.000	ST
6	6.362-186.0	O-Ring seal 7,65X 1,78	1.000	ST
3	6.362-922.0	O-Ring seal 8,73x1,78	4.000	ST
11	6.516-001.0	Pocket accessories SC 1	1.000	ST
7	4.130-431.0	Point jet nozzle complete black	1.000	ST
10	2.863-263.0	Power nozzle set	1.000	ST
8	2.863-264.0	Round brushes set	1.000	ST
1	4.590-007.0	Safety lock replacement SC 1	1.000	ST
2	5.363-635.0	Seal	1.000	ST

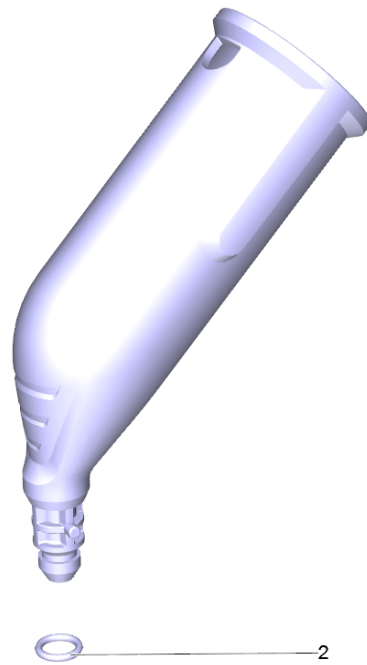

53 Point jet nozzle complete black (4.130-431.0)

POS	Article no.	Description	Quantity	Unit
2	6.362-186.0	O-Ring seal 7,65X 1,78	1.000	ST

9000 Housing complete replacement SC 1 yw (4.512-100.0)

POS	Article no.	Description	Quantity	Unit
1	5.037-009.0	Snap-fit SC 1	1.000	ST

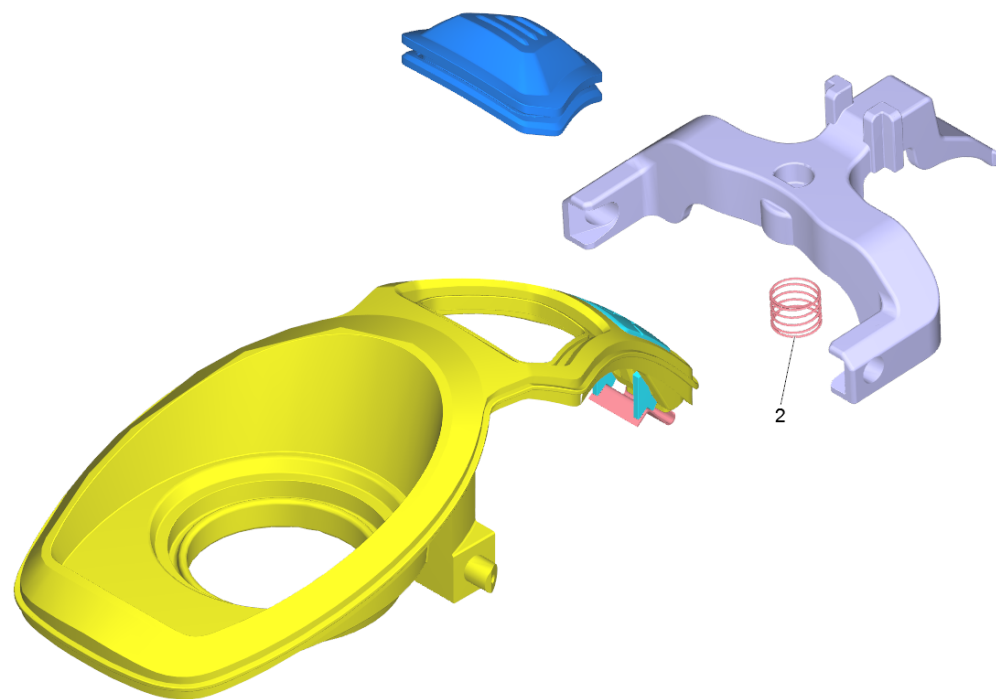

9001 Housing insert complete replacement SC 1 (4.512-099.0)

POS	Article no.	Description	Quantity	Unit
2	6.330-083.0	Pressure spring	1.000	ST

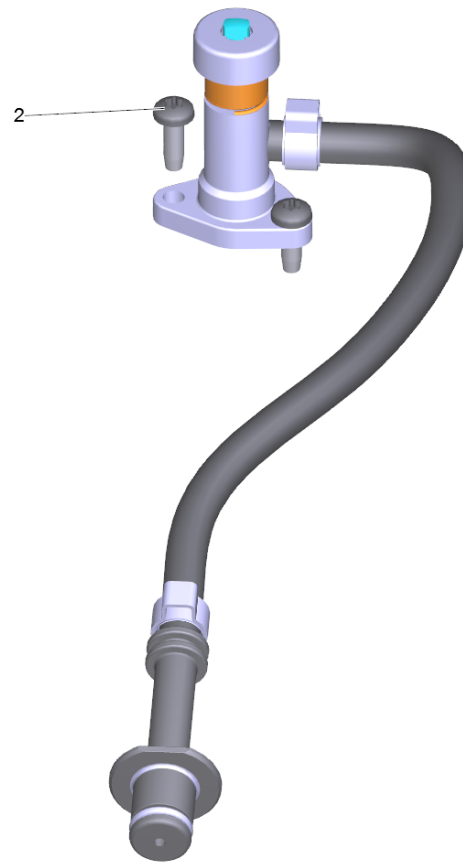

9006 Valve complete replacement SC 1 (4.580-045.0)

POS	Article no.	Description	Quantity	Unit
2	7.303-032.0	Screw M4x12 -St-R2R (In6Rd)	2.000	ST

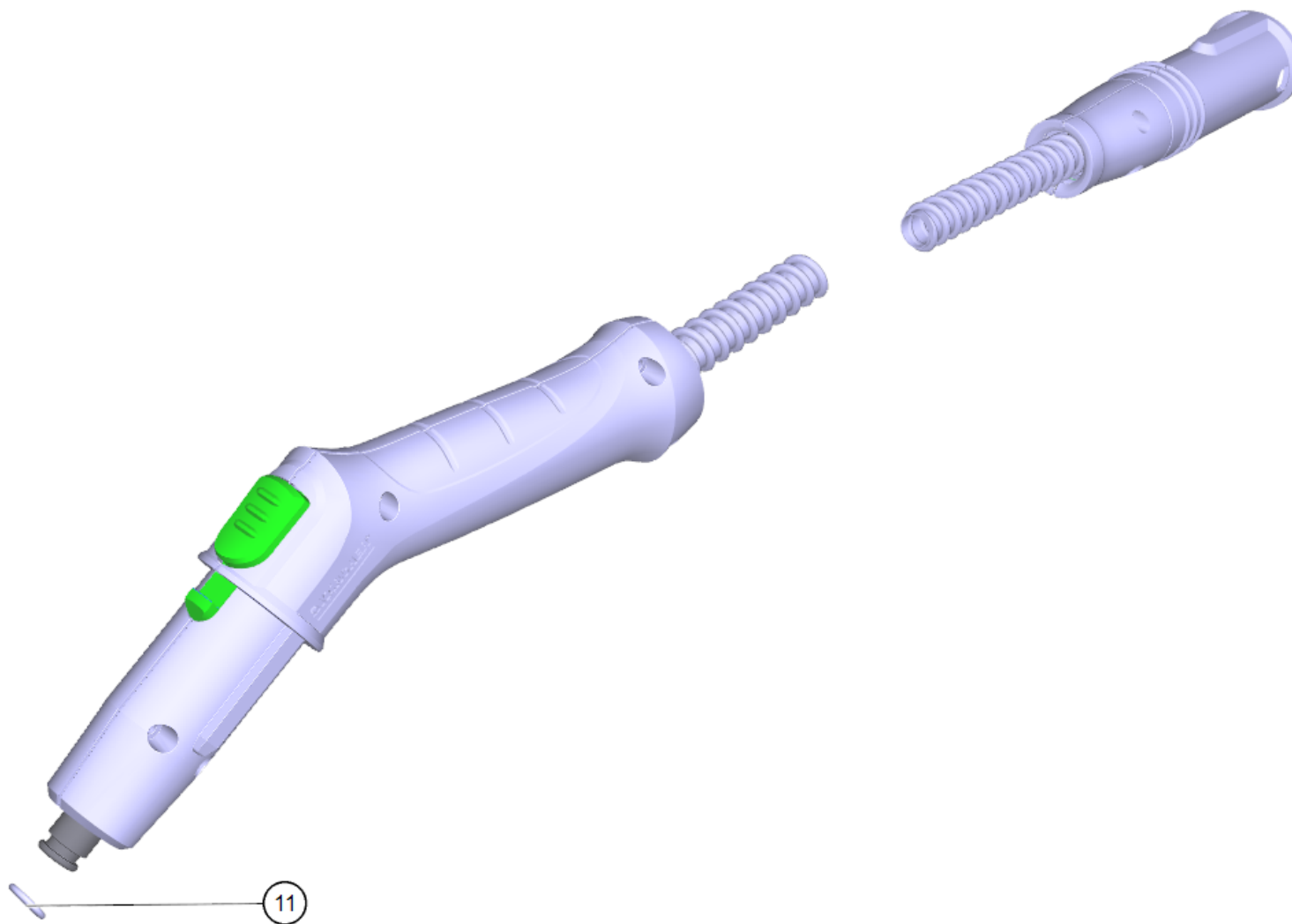

9501 Extension hose special accessories SC 1 (2.863-021.0)

POS	Article no.	Description	Quantity	Unit
11	6.362-922.0	O-Ring seal 8,73x1,78	1.000	ST