

# 50 Short spare parts list (1.520-932.3)

Professional \ High pressure cleaner cold water \ Electric motor \ HD 5/15 CX Plus \*EU \ Short spare parts list

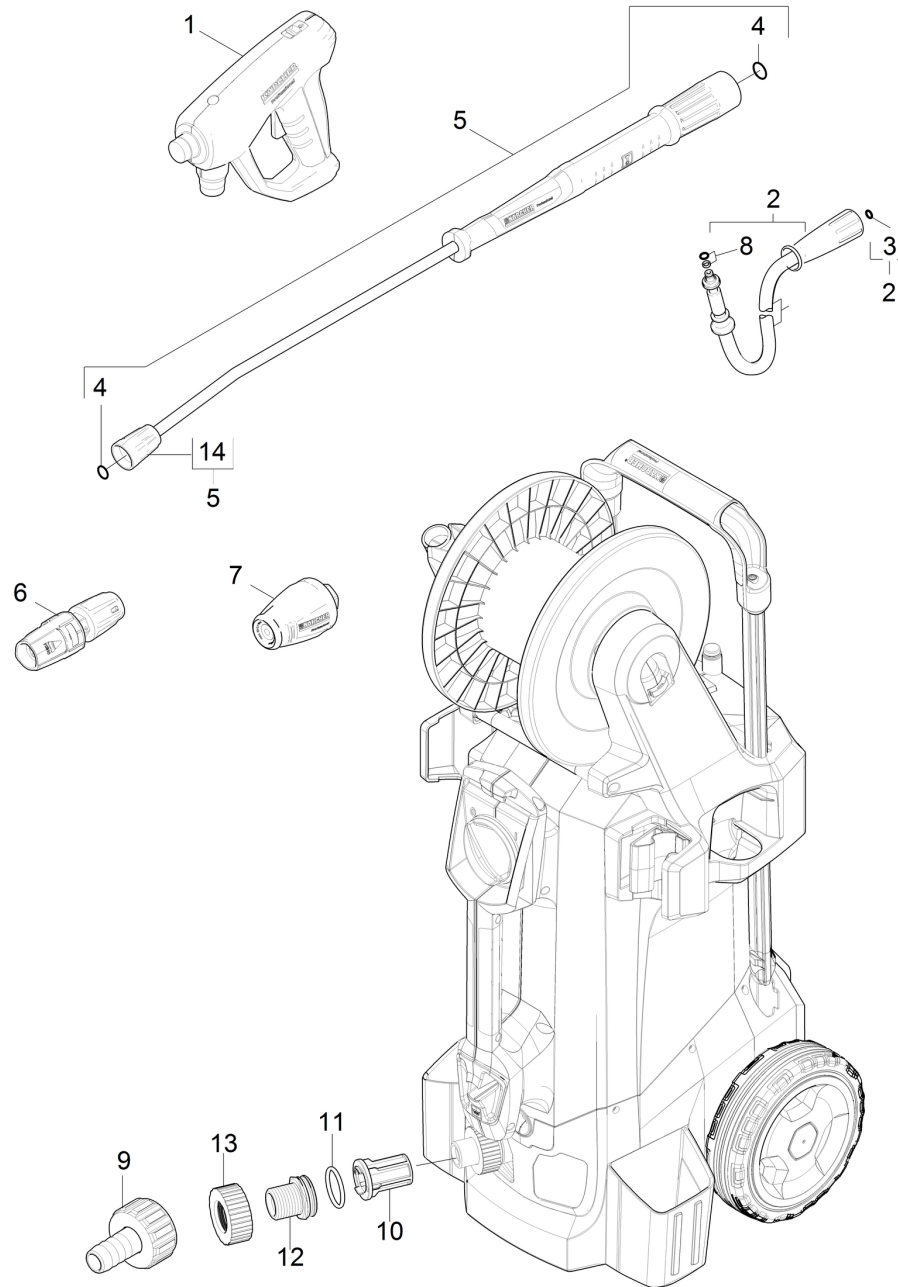

## 50 Short spare parts list (1.520-932.3)

Professional \ High pressure cleaner cold water \ Electric motor \ HD 5/15 CX Plus \*EU \ Short spare parts list

**KÄRCHER**

POS	Article no.	Description	Quantity	Unit
1	4.118-005.0	EASY!Force Advanced	1.000	ST
2	6.110-036.0	Hose assembly TR DN6 25MPa 15m	1.000	ST
3	2.880-154.0	O-Ring kit	1.000	ST
4	2.880-001.0	Spare part set seals TR	2.000	ST
5	4.112-006.0	Jet pipe TR 840 mm	1.000	ST
6	4.117-027.0	Triple jet nozzle TR 032	1.000	ST
7	4.114-019.0	Dirt blaster TR 035 LowEnd	1.000	ST
8	4.363-691.0	O-Ring seal kpl. -nur fuer Ersatz-	1.000	ST
9	4.401-056.0	Screw connector part	1.000	ST
10	5.731-666.0	Filter cartridge with cone	1.000	ST
11	6.363-437.0	O-Ring seal 30x3	1.000	ST
12	5.064-423.0	Connection piece water intake	1.000	ST
13	5.064-465.0	Nut water intake	1.000	ST
14	4.112-011.0	Protection part TR only for replacement	1.000	ST