

10 Surface cleaner

Overview technical documents/Professional/High pressure cleaner cold water/Accessories/FR 30 Me (2.640-355.0)/Spare parts list FR 30/10 Surface cleaner

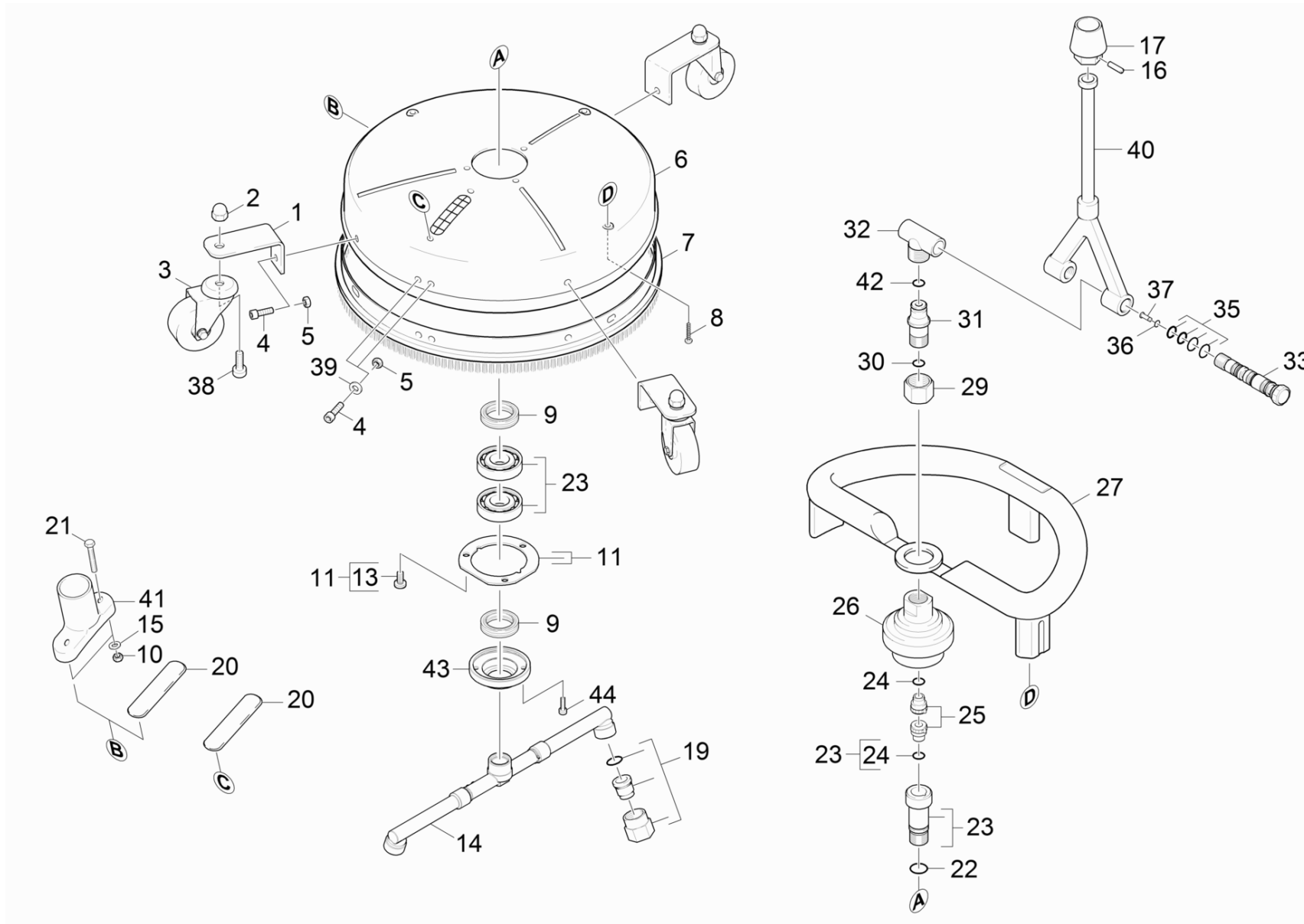

10 Surface cleaner

Overview technical documents/Professional/High pressure cleaner cold water/Accessories/FR 30 Me (2.640-355.0)/Spare parts list FR 30/10 Surface cleaner

Rez.daļas/nodil.pakļ.daļas	Poz.	Materiāla Nr.	Nosaukums	Daudzums	Pārdoš. vienība	no sēr. Nr..	līdz sēr. Nr.
	1	5.058-584.0	Holder	3.000	ST	0000000000	0000000000
	2	7.311-402.0	Cap nut M10-A1-50 DIN 1587	3.000	ST	0000000000	0000000000
X	3	6.435-694.0	Castor	3.000	ST	0000000000	0000000000
	4	7.306-192.0	Screw M 6x 12-A2-70 (In6Rd)	7.000	ST	0000000000	0000000000
	5	7.311-422.0	Hexagon nut M 6-1.4305 ISO 10511	7.000	ST	0000000000	0000000000
	6	5.058-555.0	Cover	1.000	ST	0000000000	0000000000
	7	6.369-831.0	Brush-corona FR 30	1.000	ST	0000000000	0000000000
	8	7.303-117.0	Screw 4x20 -A2-70 (In6Rd)	3.000	ST	0000000000	0000000000
X-X	9	7.367-000.0	Radial shaft seal ring A20x30x7-NBR DIN	2.000	ST	0000000000	0000000000
	10	7.311-028.0	Hexagon nut M 4-04-A2E ISO 4035	2.000	ST	0000000000	0000000000
	11	4.880-002.0	Spare part set flange	1.000	ST	0000000000	0000000000
	13	7.306-180.0	Screw M5x10-A2-70 (In6Rd)	3.000	ST	0000000000	0000000000
	14	4.764-154.0	Nozzle holder	1.000	ST	0000000000	0000000000
	15	7.312-067.0	Washer 4-A2 ISO 7089	2.000	ST	0000000000	0000000000
	16	6.343-150.0	Pin 03	1.000	ST	0000000000	0000000000
	17	5.394-530.0	Protection part complete	1.000	ST	0000000000	0000000000
X-X	19	2.640-442.0	Nozzle pack 032	1.000	ST	0000000000	0000000000
X-X	19	2.639-187.0	Nozzle pack	1.000	ST	0000000000	0000000000
X	19	2.639-188.0	Nozzle pack 04-1100-1300 l/h	1.000	ST	0000000000	0000000000
X-X	19	2.640-401.0	Nozzle	1.000	ST	0000000000	0000000000
X-X	19	2.640-482.0	Nozzle pack 018	1.000	ST	0000000000	0000000000
	20	5.064-128.0	Cover	2.000	ST	0000000000	0000000000
	21	7.306-209.0	Screw M 4X 20-A2-70 (In6Rd)	2.000	ST	0000000000	0000000000
	22	6.362-388.0	Gredzenblīve 8,0x1,5 -EPDM 70	1.000	ST	0000000000	0000000000
X-X	23	4.250-078.0	Bearing complete	1.000	ST	0000000000	0000000000

10 Surface cleaner

Overview technical documents/Professional/High pressure cleaner cold water/Accessories/FR 30 Me (2.640-355.0)/Spare parts list FR 30/10 Surface cleaner

Rez.daļas/nodil.pakļ.daļas	Poz.	Materiāla Nr.	Nosaukums	Daudzums	Pārdoš. vienība	no sēr. Nr..	līdz sēr. Nr.
	24	6.362-658.0	O-Ring seal 7 X 1,5-NBR 90	2.000	ST	0000000000	0000000000
X-X	25	5.111-322.0	Sleeve	2.000	ST	0000000000	0000000000
	26	5.108-267.0	Turned part	1.000	ST	0000000000	0000000000
	27	5.321-752.0	Handhold	1.000	ST		
Pozīcijas teksts: 2.641-962.0							
	27	5.321-716.0	Handhold	1.000	ST	0000000000	0000000000
Pozīcijas teksts: 2.640-355.0 /-437.0 /-447.0 /-448.0 /-449.0 /							
	29	7.383-004.0	Union nut B1 LL15 -Ms DIN3870	1.000	ST	0000000000	0000000000
	30	6.362-384.0	Gredzenblīve 9x1,5 - NBR 70	2.000	ST	0000000000	0000000000
	31	5.424-130.0	Sealing cone	1.000	ST	0000000000	0000000000
	32	5.427-314.0	T-Piece	1.000	ST	0000000000	0000000000
	33	5.100-428.0	Shaft	1.000	ST	0000000000	0000000000
X	35	2.883-982.0	Spare part set O-Ring seal	1.000	ST	0000000000	0000000000
	36	6.362-360.0	O-Ring seal 4,0 X 1,0-EPDM 77	1.000	ST		
	37	5.317-098.0	Bolt	1.000	ST	0000000000	0000000000
	38	7.306-234.0	Cil. galvas skr. M10x20-A4-70 ISO 47	3.000	ST	0000000000	0000000000
X-X	39	7.312-026.0	Washer 6-A2 ISO 7090	7.000	ST	0000000000	0000000000
	40	4.481-207.0	Joint	1.000	ST	0000000000	0000000000
	41	5.032-474.0	Suction connection	1.000	ST	0000000000	0000000000
	42	2.880-154.0	O-Ring kit	1.000	ST	0000000000	0000000000
	43	5.122-478.0	Flange	1.000	ST	0000000000	0000000000
	44	7.306-204.0	Screw M 3X 10-A2-70 (IN6RD)	4.000	ST	0000000000	0000000000