

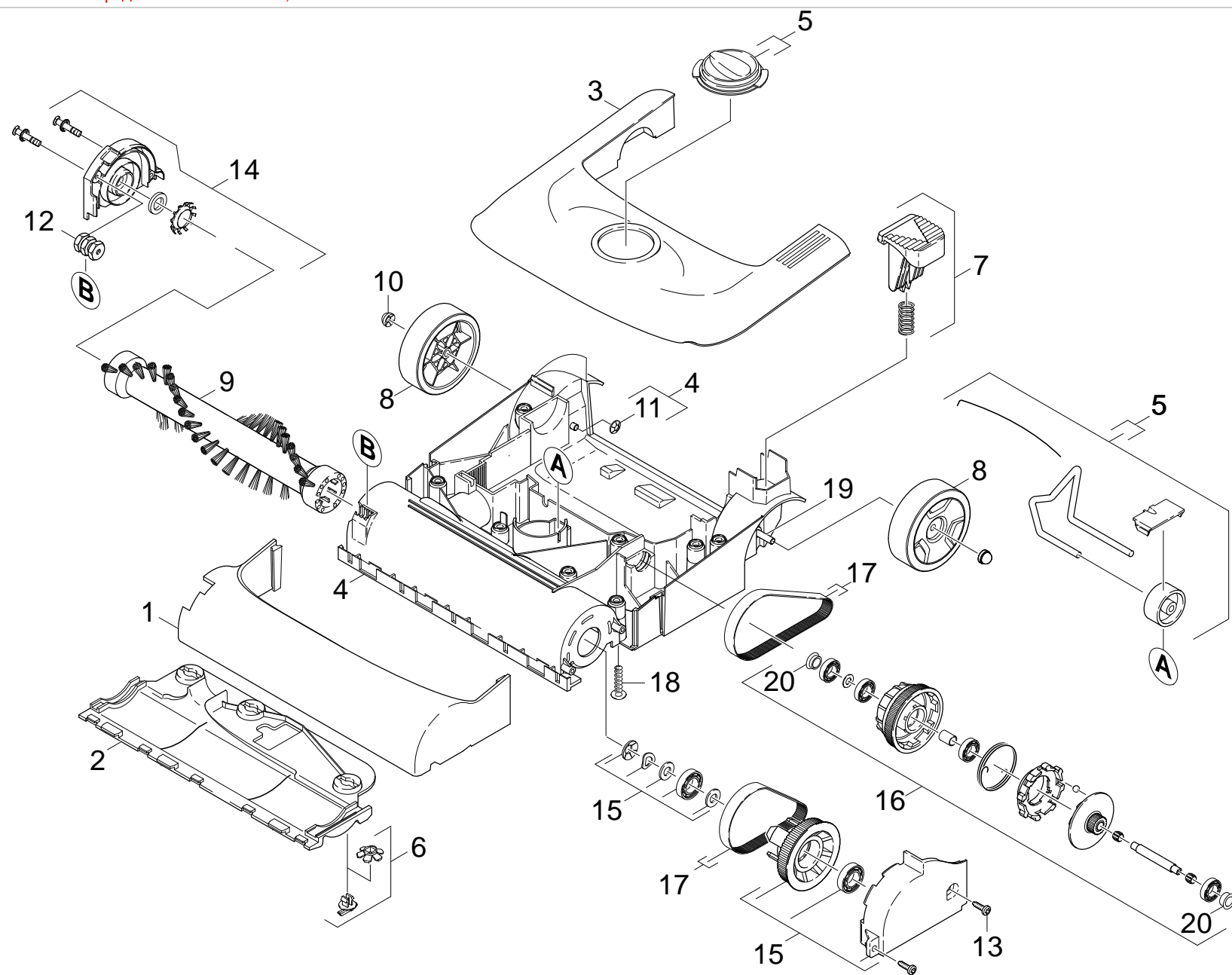











































.. \.. \.. \.. \.. \.. \.. \20 Верхняя часть щетки (0.166-360.0)

Детали, не установленные в определенное положение, не являются запасными частями



	ЗЧ/БЧ	Поз.	Материальный №	Обозначение	Количество	Единица	от № WK	до № WK
		1	5.032-456.0	Амортизатор	1.000	ST	0000000000	0000000000
		2	5.058-500.0	Скользящая подошва	1.000	ST	0000000000	0000000000
		3	5.062-429.0	Корпус верхняя часть серый базальт RAL 7	1.000	ST	0000000000	0000000000
		4	4.060-697.0	Корпус в сборе CV30/1	1.000	ST	0000000000	0000000000
		5	4.515-335.0	Перестановка колеса комплектный	1.000	ST	0000000000	0000000000
	 	6	2.889-084.0	Набор деталей замка для замены	1.000	ST	0000000000	0000000000
		7	4.481-265.0	Педаль в сборе	1.000	ST	0000000000	0000000000
		8	5.515-374.0	Колесо CV 30/1	2.000	ST	0000000000	0000000000
	 	9	6.906-641.0	Черная цилиндрическая щетка	1.000	ST	0000000000	0000000000
	 	10	6.343-187.0	Стопорная шайба	2.000	ST	0000000000	0000000000
	 	11	6.343-119.0	Стопорная шайба	2.000	ST	0000000000	0000000000
		12	5.401-288.0	Резьбовое соединение	2.000	ST	0000000000	0000000000
		13	7.303-106.0	Винт 4x12 -10.9-R2R (IN6RD)	2.000	ST	0000000000	0000000000
	 	14	4.063-892.0	Держатель щетки в сборе	1.000	ST	0000000000	0000000000
	 	15	4.063-774.0	Кожух в комплекте с ремнем CV 30/1	1.000	ST	0000000000	0000000000
	 	16	4.470-022.0	Муфта в сборе	1.000	ST	0000000000	0000000000
	 	17	2.884-274.0	КЗЧ ремень	1.000	ST	0000000000	0000000000
	 	18	7.303-108.0	Винт 5x20 -10.9-R2R (In6Rd)	8.000	ST	0000000000	0000000000
	 	19	9.412-178.0	Ось	1.000	ST		
		20	5.032-617.0	Фасонная деталь кольцо	2.000	ST		