

# SIEMENS

## SIMATIC

### PG/PC - PROFIBUS PC Adapter USB A2

#### Operating Instructions

#### Preface

#### Description of the device

1

#### Software installation

2

#### Hardware installation

3

#### Setting

4

#### Technical specifications

5



#### Approvals

A

## Legal information

### Warning notice system

This manual contains notices you have to observe in order to ensure your personal safety, as well as to prevent damage to property. The notices referring to your personal safety are highlighted in the manual by a safety alert symbol, notices referring only to property damage have no safety alert symbol. These notices shown below are graded according to the degree of danger.

 <b>DANGER</b>
indicates that death or severe personal injury <b>will</b> result if proper precautions are not taken.
 <b>WARNING</b>
indicates that death or severe personal injury <b>may</b> result if proper precautions are not taken.
 <b>CAUTION</b>
indicates that minor personal injury can result if proper precautions are not taken.
<b>NOTICE</b>
indicates that property damage can result if proper precautions are not taken.

If more than one degree of danger is present, the warning notice representing the highest degree of danger will be used. A notice warning of injury to persons with a safety alert symbol may also include a warning relating to property damage.

### Qualified Personnel

The product/system described in this documentation may be operated only by **personnel qualified** for the specific task in accordance with the relevant documentation, in particular its warning notices and safety instructions. Qualified personnel are those who, based on their training and experience, are capable of identifying risks and avoiding potential hazards when working with these products/systems.

### Proper use of Siemens products

Note the following:

 <b>WARNING</b>
Siemens products may only be used for the applications described in the catalog and in the relevant technical documentation. If products and components from other manufacturers are used, these must be recommended or approved by Siemens. Proper transport, storage, installation, assembly, commissioning, operation and maintenance are required to ensure that the products operate safely and without any problems. The permissible ambient conditions must be complied with. The information in the relevant documentation must be observed.

### Trademarks

All names identified by ® are registered trademarks of Siemens AG. The remaining trademarks in this publication may be trademarks whose use by third parties for their own purposes could violate the rights of the owner.

### Disclaimer of Liability

We have reviewed the contents of this publication to ensure consistency with the hardware and software described. Since variance cannot be precluded entirely, we cannot guarantee full consistency. However, the information in this publication is reviewed regularly and any necessary corrections are included in subsequent editions.

# Preface

## What the consignment contains

The following parts ship with the PC Adapter USB A2:

- CD "PC Adapter USB A2 - Driver Disk"
- USB cable
- MPI cable (0.3 m)  
With the MPI cable, you can connect the PC Adapter USB A2 to MPI networks, homogeneous PPI networks or to PROFIBUS networks.

Please check that the consignment you have received is complete. If the consignment is incomplete, contact your supplier or your local Siemens office.

## Spare parts

Spare parts	Order number
USB cable	A5E00276884
MPI cable (0.3 m)	A5E00164946

You can order spare parts through your local Siemens contact.

## Documentation

### Validity of this documentation

These operating instructions are valid for the following product:

- PC Adapter USB A2  
Article number: 6GK 1571-0BA00-0AA0

---

### Note

The PC Adapter USB A2 (article number 6GK 1571-0BA00-0AA0) replaces the PC Adapter USB (article number 6ES7 972-0CB20-0XA0).

---

## Content of this documentation

These operating instructions contain information on the installation and use of the PC Adapter USB A2.

## Required basic experience

To understand the operating instructions, you require general knowledge of automation engineering.

You also need to be familiar with using computers or tools similar to PCs (for example programming devices) with the Microsoft Windows operating system.

## Updated operating instructions on the Internet

You will find the current version of these operating instructions on the Product Support pages under the following entry ID:

68849363 (<https://support.industry.siemens.com/cs/ww/en/view/68849363>)

## Further support

If you have questions on the use of the products described in the manual and you do not find the answers here, ask your Siemens contact in the Siemens agency or office responsible for you. You will find your contacts at:

(<http://www.siemens.com/automation/partner>)

You will find the links to the available technical documentation for the individual SIMATIC products and systems at:

(<http://www.siemens.de/simatic-tech-doku-portal>)

The online catalog and online ordering system can be found at:

(<http://mall.automation.siemens.com/>)

## Further documentation

The documents listed below contain more detailed information on setting up and using the programming device. You will find this documentation on the Product Support pages on the Internet with the following link:

Support (<https://support.industry.siemens.com/cs/ww/en/ps>)

Enter the entry ID shown below of the relevant manual as the search item.

- System manual PROFIBUS network manual  
In this document, you will find detailed information on setting up a PROFIBUS network.  
Entry ID:  
35222591 (<https://support.industry.siemens.com/cs/ww/en/view/35222591>)

## SIMATIC NET documentation

You will find the entire SIMATIC NET documentation on the pages of Product Support:

10805878 (<https://support.industry.siemens.com/cs/ww/en/ps/15247>)

Go to the required product group and make the following settings:

→ Entry list → Entry type "Manuals / Operating Instructions"

## Trademarks

The following and possibly other names not identified by the registered trademark sign ® are registered trademarks of Siemens AG:

SIMATIC NET, HARDNET, SOFTNET, CP 1612, CP 1613, CP 5612, CP 5613, CP 5614, CP 5622

## Industry Online Support

In addition to the product documentation, the comprehensive online information platform of Siemens Industry Online Support at the following Internet address:

(<http://support.automation.siemens.com/WW/llisapi.dll?func=cslib.csinfo2&aktprim=99&lang=en>)

Apart from news, there you will also find:

- Project information: Manuals, FAQs, downloads, application examples etc.
- Contacts, Technical Forum
- The option submitting a support query:  
(<https://support.automation.siemens.com/WW/llisapi.dll?func=cslib.csinfo&lang=en&objid=38718979&caller=view>)
- Our service offer:

Right across our products and systems, we provide numerous services that support you in every phase of the life of your machine or system - from planning and implementation to commissioning, through to maintenance and modernization.

You will find contact data on the Internet at the following address:

(<http://www.automation.siemens.com/partner/guiwelcome.asp?lang=en>)

## SITRAIN - Training for Industry

The training offer includes more than 300 courses on basic topics, extended knowledge and special knowledge as well as advanced training for individual sectors - available at more than 130 locations. Courses can also be organized individually and held locally at your location.

You will find detailed information on the training curriculum and how to contact our customer consultants at the following Internet address:

([www.siemens.com/sitrain](http://www.siemens.com/sitrain))

## SIMATIC NET glossary

Explanations of many of the specialist terms used in this documentation can be found in the SIMATIC NET glossary.

You will find the SIMATIC NET glossary on the Internet at the following address:

50305045 (<http://support.automation.siemens.com/WW/view/en/50305045>)



# Table of contents

	<b>Preface</b> .....	<b>3</b>
<b>1</b>	<b>Description of the device</b> .....	<b>9</b>
1.1	Properties of the PC Adapter USB A2 .....	9
1.2	Function .....	9
1.3	Characteristics .....	10
1.4	Ports .....	11
1.5	Power supply .....	11
1.6	MPI/DP interface .....	12
1.7	USB interface .....	13
1.8	Meaning of the LED display .....	14
<b>2</b>	<b>Software installation</b> .....	<b>15</b>
2.1	Software requirements .....	15
2.2	Installing the driver .....	16
<b>3</b>	<b>Hardware installation</b> .....	<b>17</b>
3.1	Hardware requirements .....	17
3.2	Connecting the PC Adapter USB A2 .....	17
3.3	Use with a stand-alone system .....	18
3.4	Use in a networked system .....	18
<b>4</b>	<b>Setting</b> .....	<b>21</b>
4.1	Set PG/PC Interface .....	21
<b>5</b>	<b>Technical specifications</b> .....	<b>23</b>
<b>A</b>	<b>Approvals</b> .....	<b>25</b>





## Description of the device

### 1.1 Properties of the PC Adapter USB A2

The PC Adapter USB A2 can be operated on USB V1.1, V2.0 or V3.0 interfaces. The PC Adapter USB A2 supports the common energy-saving modes (for example hibernate mode).

---

**Note**

The PC Adapter USB A2 is compatible with its predecessor product "PC Adapter USB".

---

### 1.2 Function

The PC Adapter USB A2 connects a PC via a USB interface with the MPI/DP interface of an S7/M7/C7 system.

Since no internal slot is required for the connection, the PC Adapter USB A2 is also suitable for PCs that cannot be expanded (for example notebooks).

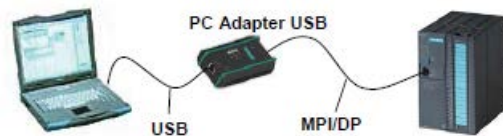

Figure 1-1 Configuration with PC Adapter USB A2

---

**Note****Only one PC Adapter USB A2**

Only one PC Adapter USB A2 can be operated on a PC.

---

## 1.3 Characteristics

### Characteristics

You can operate the PC Adapter USB A2 on MPI and PROFIBUS networks.

The following table shows which transmission speeds are supported by the PC Adapter USB A2 on which network type.

Table 1- 1 Bus profiles and transmission speeds

Transmission speed	MPI	PPI	PROFIBUS			
			DP	Standard	Universal	User defined
9.6 kbps	-	(✓)*	✓	✓	✓	✓
19.2 kbps	✓	(✓)*	✓	✓	✓	✓
45.45 kbps	-	-	✓	✓	-	✓
93.75 kbps	-	-	✓	✓	✓	✓
187.5 kbps	✓	(✓)*	✓	✓	✓	✓
500 kbps	-	-	✓	✓	✓	✓
1.5 Mbps	✓	-	✓	✓	✓	✓
3 Mbps	✓	-	✓	✓	-	✓
6 Mbps	✓	-	✓	✓	-	✓
12 Mbps	✓	-	✓	✓	-	✓

(✓)\* The PPI bus profile can be used via the "Universal" PROFIBUS bus profile

### Further features

- Automatic bus profile detection
- Up to 16 communications connections of which a maximum of 4 can be slaves (DP/T connections)
- Support of routing
- The PC Adapter USB A2 supports the following access to DP slaves:
  - Slave address assignment
  - Device diagnostics
  - Read/write data record

## 1.4 Ports

The PC Adapter USB A2 has the following connectors and displays:



## 1.5 Power supply

The PC Adapter USB A2 is supplied with power via the USB cable.

The PC Adapter USB A2 has electrical isolation between its MPI/DP and USB interface within a safety extra low voltage (SELV) circuit. It can therefore also be operated directly on ungrounded S7/M7/C7 systems.

### See also

Technical specifications (Page 23)

## 1.6 MPI/DP interface

### Pin assignment

The MPI/DP socket has the following pin assignment:

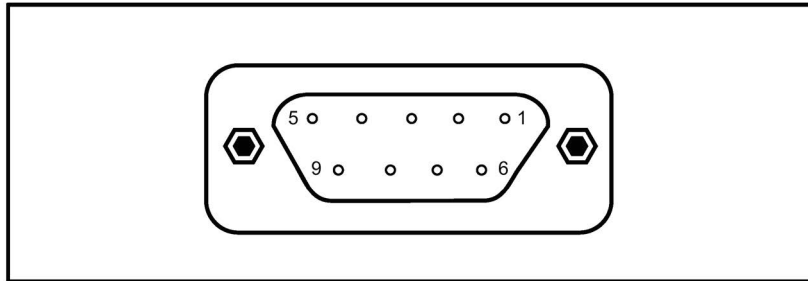

### Signal description

Pin no.	Short description	Meaning	Input/output
1	NC	not connected	-
2	NC	not connected	-
3	LTG_B	Data line B	Input and output
4	RTS_AS	RTSAS, control signal for received data stream. The signal is '1' active when the directly connected S7 automation system sends.	Input
5	M5V	Reference potential of the MPI/DP interface for the signals RTS_AS and RTS_PG	Output
6	P5V	+5 V (only for bus termination)	Output
7	NC	not connected	-
8	LTG_A	Data line A	Input and output
9	RTS_PG	RTS output signal of the PC Adapter USB A2. The signal is '1' when the PC Adapter USB A2 sends. The signal is not included in the 0.3 m MPI cable!	Output
Shield	-	on connector housing*	-

\* The shield is connected through to the USB socket via the adapter electronics module.

## 1.7 USB interface

### Interface assignment

USB socket from above:

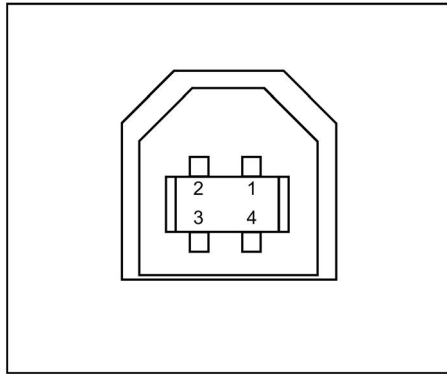

Figure 1-2 USB interface

### Signal description

Pin no.	Signal	Meaning
1	+5V	Supply voltage
2	-Data	- differential signal
3	+Data	+ differential signal
4	Ground	Ground

#### Note

If several USB devices are being operated on your PC, this can impair the performance of the PC Adapter USB A2. If optimum performance is required by the functions for communicating with the automation system, USB devices you do not require should be unplugged.

#### NOTICE

##### Disrupted function or communication abort possible

Removing and inserting USB devices can cause functional disruptions on the USB interface. In extreme situations, this can lead to the communication via the PC Adapter USB A2 being aborted meaning that the application needs to be restarted.

## 1.8 Meaning of the LED display

The LEDs on the PC Adapter USB A2 have the following meaning:

Designation	Color	Meaning
ACTIVITY	green	<ul style="list-style-type: none"> <li>• <b>LED off:</b> no application active</li> <li>• <b>LED on:</b> application active</li> <li>• <b>LED flickers:</b> Application active, PC Adapter USB A2 is in the token ring (bus activity)</li> <li>• <b>LED flashing:</b> Flashing function via the PG/PC panel active (twice a second)</li> </ul>
FAULT	red	<ul style="list-style-type: none"> <li>• <b>LED off:</b> No disruptions</li> <li>• <b>LED flashes fast (twice a second):</b> serious internal problem</li> <li>• <b>LED flashes rhythmically:</b> Bus disruption</li> </ul>
USB 5V	green	<ul style="list-style-type: none"> <li>• <b>LED on:</b> The PC Adapter USB A2 is being detected by the driver and is operational.</li> <li>• <b>LED off:</b> The 5 V supply voltage is not available.</li> <li>• <b>LED flashes slowly:</b> <ul style="list-style-type: none"> <li>– The driver software is not installed.</li> <li>– The operating system is not active.</li> <li>– The PC Adapter USB A2 was "thrown out".</li> <li>– The PC Adapter USB A2 is disabled in the Windows hardware manager.</li> <li>– The power supply of the USB interface is inadequate to operate the PC Adapter USB A2.</li> </ul> </li> </ul>
All 3 LEDs are lit permanently	-	<p><b>Hardware defect:</b> Replace the PC Adapter USB A2 and send the defective device to your Siemens contact.</p>

## Software installation

### 2.1 Software requirements

To work with the PC Adapter USB A2, you require a PC with one of the following operating systems:

- Windows Server 2012 R2
- Windows 10
- Windows 8.1
- Windows 8
- Windows 7
- Windows Server 2008 R2
- Windows XP Professional SP2 or higher
- Windows XP Home SP2 or higher
- Windows Server 2003 Standard Edition
- Windows Vista

and

- a SIMATIC software package that accesses using MPI communication (for example STEP 7)

To operate the PC Adapter USB A2 on a PPI network, you also require the software package STEP 7 Micro/Win32.

## 2.2 Installing the driver

### Requirements for installation

---

**Note****Software requirements**

A SIMATIC product (for example STEP 7) must already be installed on your PC before you install the driver.

---

### Procedure

The installation starts automatically after inserting the CD.

If this function is disabled, follow the steps below:

1. Insert the "PC Adapter USB A2 - Driver Disk" in the CD-ROM drive.
2. Open the main directory on this drive.
3. Start the setup program by clicking on the "setup.exe" file.

The setup program guides you through the entire installation. Note the information on the installation and use of the PC Adapter USB A2 in the readme file that you will find in the main directory on the CD.



## Hardware installation

### 3.1 Hardware requirements

You require a PC with a USB interface (USB 1.1, 2.0 or 3.0) and a CD/DVD-ROM drive.

### 3.2 Connecting the PC Adapter USB A2

#### Connecting to the PC

1. Insert the supplied USB cable in a USB interface of your PC.
2. Insert the other end of the USB cable into the USB interface of the PC Adapter USB A2.

#### Connecting to the automation system

1. Insert the supplied MPI cable into the PC Adapter USB A2 and screw it tight.
2. Connect the other end of the MPI cable to the MPI/PG interface of your CPU and screw it tight.

---

**Note**

The PC Adapter USB A2 and the S7/M7/C7 system each represent a network node.

- In networks made up of 2 nodes (PC Adapter USB A2 and S7/M7/C7 system), the PC Adapter USB A2 is operated directly on the socket of the S7/M7/C7 system.
  - In networks made up of more than 2 nodes, the PC Adapter USB A2 is connected to the "PG socket" of a PROFIBUS connector (SINEC L2 bus connector). This does not require any change to the setting of the terminating resistors.
- 

#### Connecting the PC Adapter USB A2 to the PROFIBUS network

A maximum of 32 nodes can be connected to a PROFIBUS network segment. Several network segments can be connected together using PROFIBUS repeaters to create a complete network with a maximum of 127 nodes. The transmission speed in the PROFIBUS network is a maximum of 12 Mbps.

The PC Adapter USB A2 supports transmission speeds up to maximum of 12 Mbps.

<b>NOTICE</b>
<b>Do not insert any extension cords</b>
No extension cord may be inserted in the connection between the PC Adapter USB A2 and S7/M7/C7 system.

### Removing the PC Adapter USB A2

You need to terminate existing communication (e.g. online diagnostics) before you disconnect the PC Adapter USB A2 from your PC.

You must also deactivate the PC Adapter USB A2 in a secure manner before you disconnect it from the PG/PC. To do this, click the "Safely Remove Hardware" icon in the taskbar notification area.

### 3.3 Use with a stand-alone system

The following figure shows the connection to a single system (1 network node).

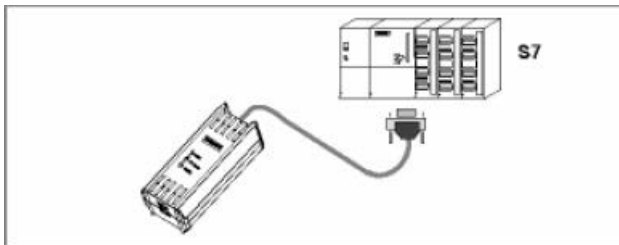

After successful installation of the PC Adapter USB A2 and configuration with the PG/PC interface, your SIMATIC software package can communicate with the automation system.

### 3.4 Use in a networked system

The following figure shows you the connection to a networked S7 system (PROFIBUS network with 2 or more network nodes).

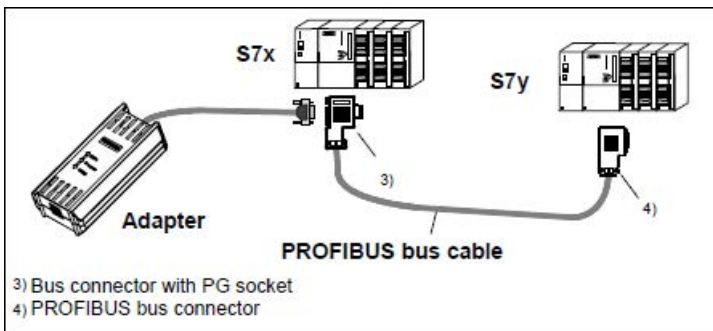

After successful installation of the PC Adapter USB A2 and configuration with the PG/PC interface, your SIMATIC software package can communicate with the automation system.





## 4.1 Set PG/PC Interface

1. In the "Set PG/PC Interface" dialog box, select the interface parameter assignment via which you want to communicate:
  - PC Adapter USB A2 (Auto)
  - PC Adapter USB A2 (MPI)
  - PC Adapter USB A2 (PROFIBUS)
2. In the corresponding "Properties" dialog box, check whether or not the parameter settings match your system configuration and if necessary modify them.
3. Complete your settings with the OK button.



## Technical specifications

<b>PC Adapter USB A2</b>	
Order number	6GK 1571-0BA00-0AA0
Dimensions	approx. 105 x 58 x 26 mm
Weight (including cable)	approx. 365 g
<b>Interfaces</b>	
to the S7/M7/C7 to the PC	RS-485 (up to max. 12 Mbps) USB 2.0 High Speed
Supply voltage (via USB interface)	5 VDC
Current consumption	200 mA
<b>Safety</b>	
Protection class	Protection class III to IEC 60950
Safety specifications	IEC 60950 corresponds to DIN/EN 60950
Degree of protection	IP20
<b>Electromagnetic compatibility (EMC)</b>	
EMC directive	The PC Adapter USB A2 meets the requirements of the EC directive 2004/108/EC (EMC directive).
Emission	Residential areas, business and commercial operations, and small businesses: EN 61000-6-3 Industrial area: EN 61000-6-4
Immunity	Residential areas, business and commercial operations, and small businesses: EN 61000-6-1 Industrial area: EN 61000-6-2
Noise immunity on signal lines	PROFIBUS cable: 2 kV (to IEC 61000-4-4, burst) USB cable: 1 kV (to IEC 61000-4-4, burst)
Immunity to discharges of static electricity (ESD)	6 kV contact discharge (to IEC 61000-4-2) 8 kV air discharge (to IEC 61000-4-2)
Immunity to RF interference	10 V/m 80 MHz – 2 GHz, 80% AM (to IEC 61000-4-3) 1 V/m 2 GHz – 2.7 GHz, 80% AM (to IEC 61000-4-3)
RF conductance	10 V/m 10 kHz - 80 MHz (to IEC 61000-4-6)
<b>Climatic conditions</b>	
Temperature Operation Storage/transportation	tested to IEC 60068-2-1, IEC 60068-2-2 +0 °C to +60 °C, temperature change max. 10 K/h -40 °C to +70 °C, temperature change max. 20 K/h
Relative humidity Operation Storage/transportation	Tested to DIN IEC 60068-2-78 5% to 95% at 30 °C tested to IEC 60068-2-30 25 °C and 55 °C at 95%

<b>PC Adapter USB A2</b>	
<b>Mechanical environmental conditions</b>	
Vibration Operation	tested to DIN IEC 60068-2-6 5 - 8.4 Hz: Amplitude 3.5 mm, 8.4 - 150 Hz: Acceleration 9.8 m/s <sup>2</sup> 10 cycles per axis
Storage/transportation	5 - 8.4 Hz: Amplitude 3.5 mm 8.4 - 500 Hz: Acceleration 9.8 m/s <sup>2</sup> 10 cycles per axis
Resistance to shock Operation	tested to DIN IEC 60068-2-27 150 m/s <sup>2</sup> , 11 ms, 6 shocks per axis
Storage/transportation	250 m/s <sup>2</sup> , 6 ms, 1000 shocks per axis



# Approvals

---

## Note

### Validity of the approvals

The specified approvals apply only when the corresponding mark is printed on the PC Adapter USB A2.

---

## Electromagnetic compatibility - EMC directive

The PC Adapter USB A2 meets the requirements of the EC directive 2004/108/EC (EMC directive).

The PC Adapter USB A2 is designed for use in the following areas:

Area of application	Requirements	
	Emission	Immunity
Residential areas, business and commercial operations, and small businesses	EN 61000-6-3	EN 61000-6-1
Industrial area	EN 61000-6-4	EN 61000-6-2

You will find further information on electromagnetic compatibility in the section "Technical specifications (Page 23)".

## EC declaration of conformity

You will find the EC declaration of conformity for this communications processor on the Product Support pages under the following entry ID:

58826997 (<https://support.industry.siemens.com/cs/ww/en/view/58826997>)

## C-TICK approval

The PC Adapter USB A2 meets the requirements of the Australian AS/NZS 3548 standard.

### cULus Approval for Information Technology Equipment

cULus Listed I. T. E.

Underwriters Laboratories Inc. complying with

- UL 60950-1 (Information Technology Equipment)
- CSA C22.2 No. 60950-1-03

Report no. E115352

### FCC approval

This equipment has been tested and found to comply with the limits for a Class A digital device, pursuant to part 15 of the FCC Rules. These limits are designed to provide reasonable protection against harmful interference when the equipment is operated in a commercial environment. This equipment generates, uses, and can radiate radio frequency energy and, if not installed and used in accordance with the instruction manual, may cause harmful interference to radio communications. Operation of this equipment in a residential area is likely to cause harmful interference in which case the user will be required to correct the interference at his own expense.

This device complies with part 15 of the FCC Rules. Operation is subject to the following two conditions:

(1) This device may not cause harmful interference, and (2) this device must accept any interference received, including interference that may cause undesired operation.

### Marking for the customs union



EAC (Eurasian Conformity)

Customs union of Russia, Belarus and Kazakhstan

Declaration of the conformity according to the technical regulations of the customs union (TR CU)