

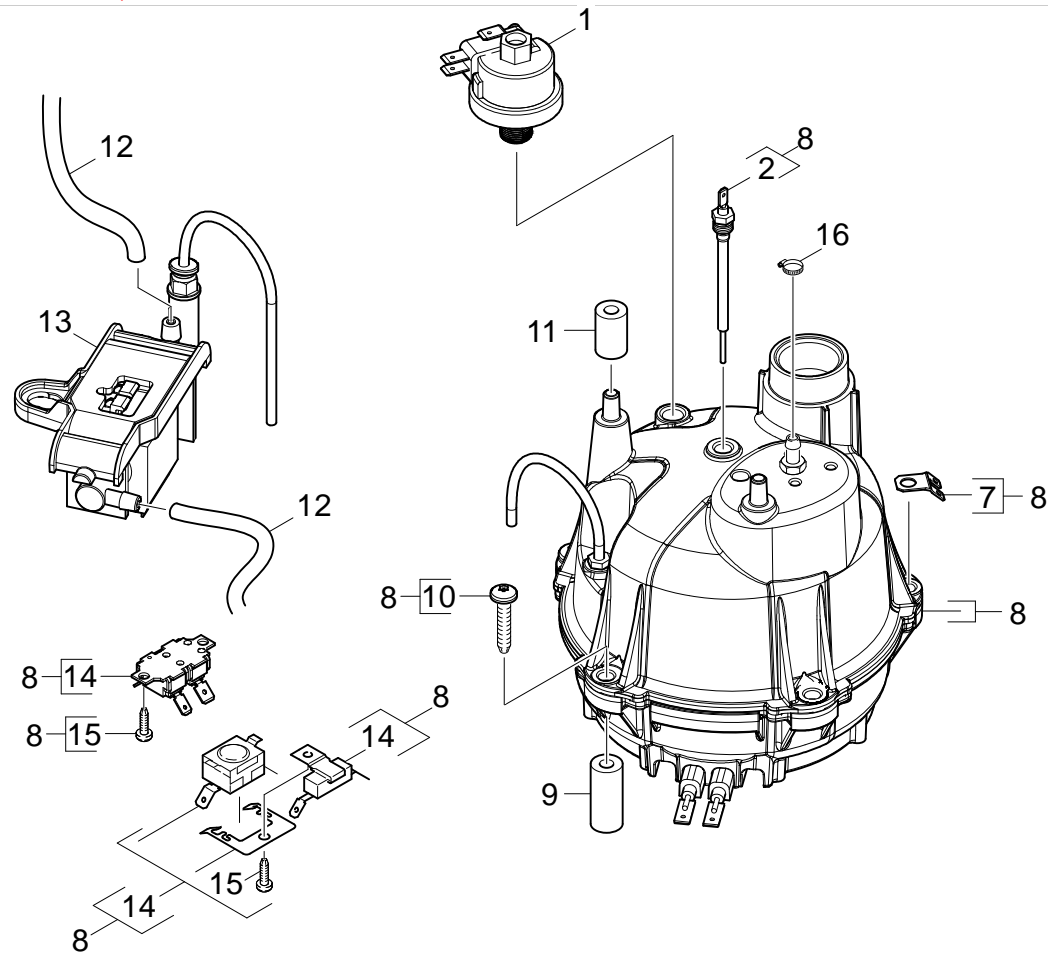























.. \.. \.. \.. \.. \ 20 Котёл (0.210-303.0)

Детали, не установленные в определенное положение, не являются запасными частями



ЗЧ/БЧ	Поз.	Материальный №	Обозначение	Количество	Единица	Текст сноски	Текст позиции
		1	6.412-280.0	Регулятор давления	1.000	ST	1.512-353.0
		1	6.413-533.0	Регулятор давления 3,2 bar	1.000	ST	1.512-350.0 / -351.0 / -352.0 / -355.0 / -357.0 / -358.0 / -359.0 / -400.0 / -401.0
		2	4.512-028.0	Зонд в комплекте на замену	1.000	ST	
		7	6.651-519.0	Плоский штепсель	1.000	ST	
		8	4.070-891.0	Котёл комплектный Ersatz SC 2.500C *BR12	1.000	ST	1.512-358.0
		8	4.070-825.0	Котел на замену SC 2.500 C	1.000	ST	1.512-350.0 / -351.0 / -352.0 / -355.0 / -357.0 / -359.0 / -400.0 / -401.0
		8	4.070-828.0	Котёл комплектный заменитель SC 2.500 C	1.000	ST	1.512-353.0
		9	6.512-001.0	Резиновый подшипник снизу	5.000	ST	
		10	6.303-324.0	Винт М 6х 32	5.000	ST	
		11	6.512-002.0	Подшипник резина сверху	2.000	ST	
		12	6.391-336.0	Шланг	1.000	М	ЗАКАЗЫВАТЬ МЕТРАЖОМ
		13	4.473-022.0	Насос комплектный МК *JP	1.000	ST	1.512-353.0
		13	4.473-020.0	Насос комплектный МК	1.000	ST	1.512-350.0 / -351.0 / -352.0 / -355.0 / -356.0 / -357.0 / -359.0 / -400.0 / -401.0
		13	4.473-031.0	Насос комплектный 127V	1.000	ST	1.512-358.0
		14	6.630-483.0	Терморегулятор	1.000	ST	1.512-350.0 / -351.0 / -352.0 / -355.0 / -357.0 / -359.0 / -400.0 / -401.0
		14	6.630-641.0	Терморегулятор 173AC/260AC	1.000	ST	1.512-353.0 / -358.0
		15	7.303-031.0	Винт М4х10 -St-P2R (In6Rd)	2.000	ST	
		16	6.389-993.0	Хомут для шланга	1.000	ST	