

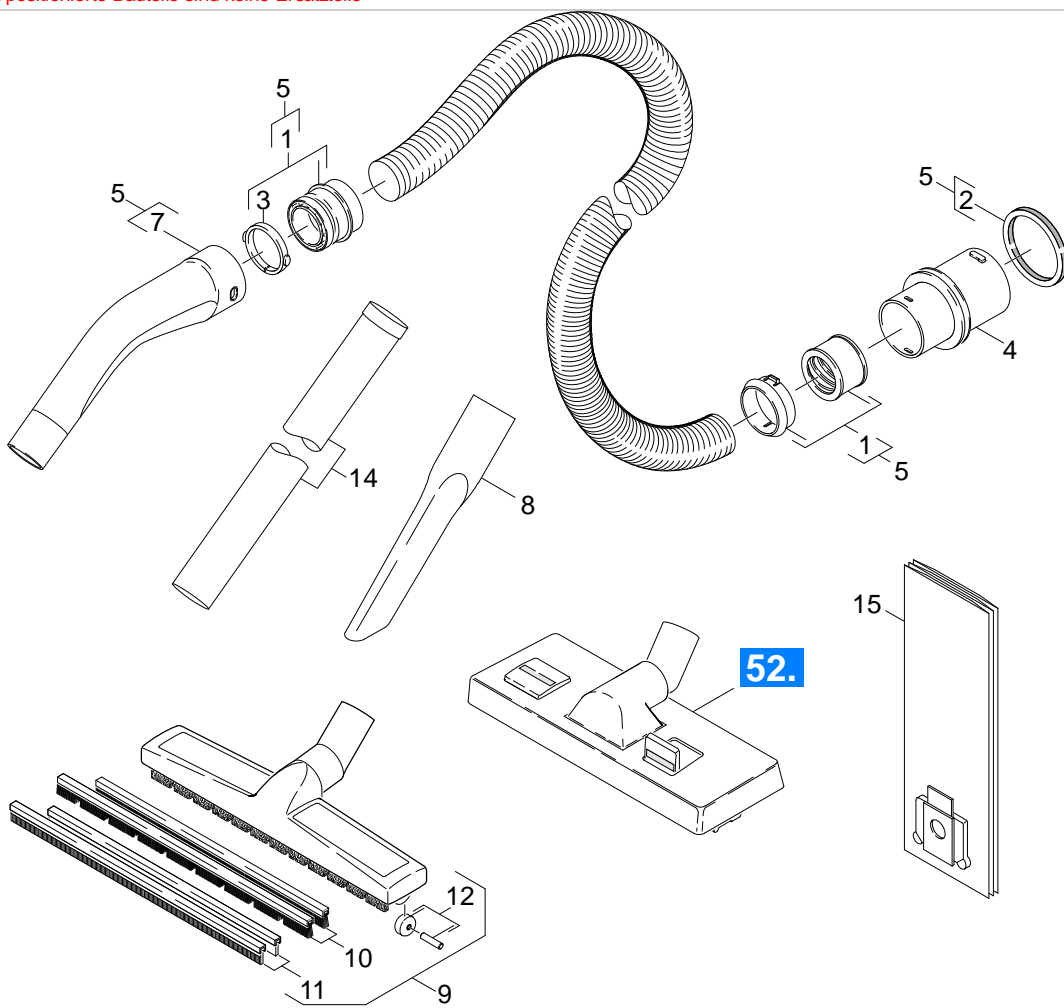





















..\..\..\..\..\ 51 Принадлежности (0.165-541.0)

Nicht positionierte Bauteile sind keine Ersatzteile



	ЗЧ/БЧ	Поз.	Материальный №	Обозначение	Количество	Единица	от № WK	до № WK
		1	2.639-690.0	Ремонтный комплект	1.000	ST	0000000000	0000000000
		2	6.273-202.0	Шнур из пористой резины	1.000	ST		
		3	5.031-703.0	Зажимное кольцо	1.000	ST	0000000000	0000000000
		4	5.443-464.0	Штуцер для шланга	1.000	ST		
		5	4.440-626.0	Всасывающий шланг C-DN35	1.000	ST		
		7	5.031-718.0	Колено	1.000	ST	0000000000	0000000000
		8	6.906-240.0	Щелевая насадка DN35	1.000	ST	0000000000	0000000000
		9	6.903-284.0	Насадка для пола DN35	1.000	ST	0000000000	0000000000
		10	6.903-278.0	Комплект щеточных полосок	1.000	ST	0000000000	0000000000
		11	6.903-277.0	Комплект уплотнительных полос	1.000	ST		
		12	4.515-342.0	Ходовой ролик с осью компл.	2.000	ST		
		14	6.900-514.0	Удлинительная трубка DN35	2.000	ST		
		15	6.904-210.0	Фильтр-мешки, 5 шт.	1.000	ZSA		