

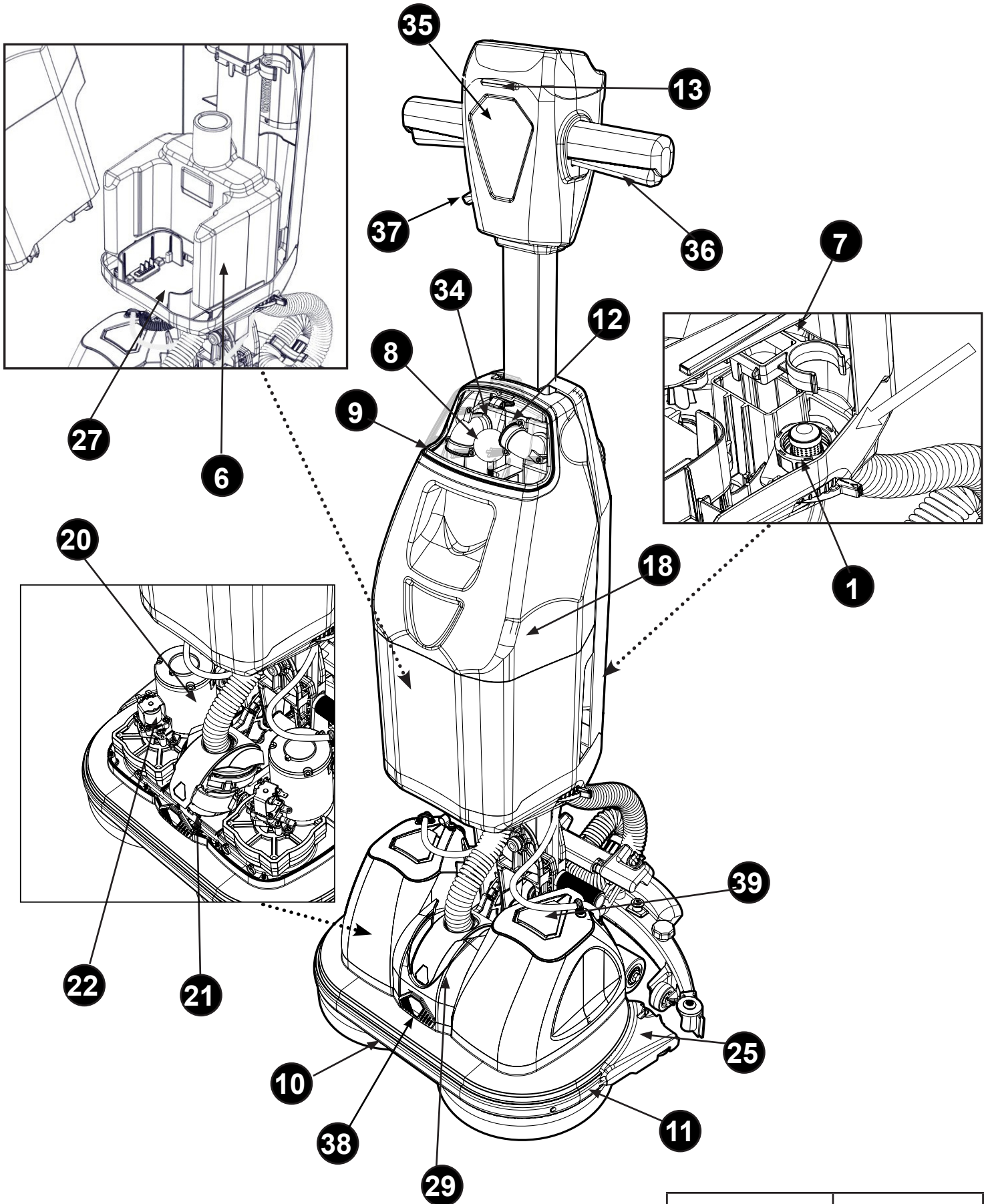

244NX Exploded Spares

Compact and Cordless Scrubber Dryer



Revision	A07
----------	-----

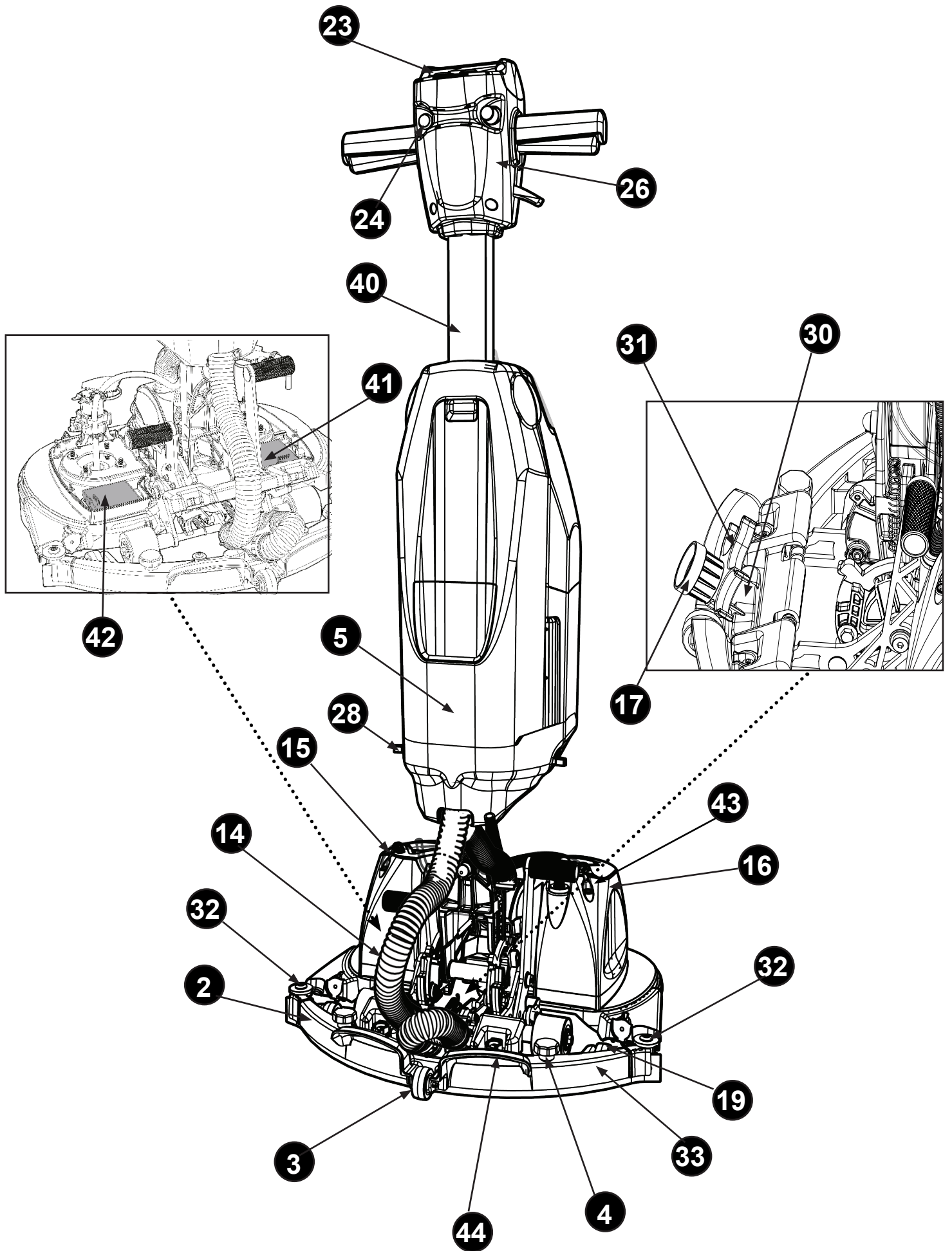

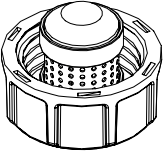
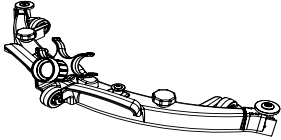
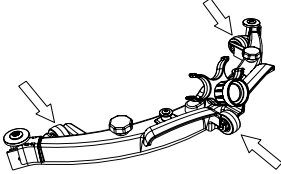
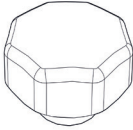
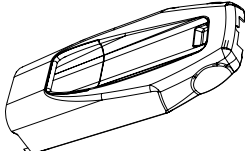
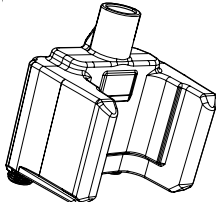
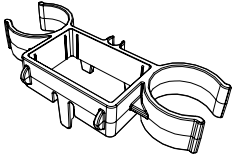
Item Number	Image Reference	Item Description	Part Number	Item Quantity
1		Clean Water Tank Valves	913829	2
2		Squeegee Assembly	913830	1
3		Squeegee Wheel Set	913831	3
4		Squeegee Retaining Knob	913832	2
5		Rear Cover Assembly	913842	1
6		Clean Water Tank	913825	1
7		Dual Hose Clip	913834	1

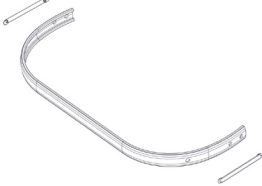
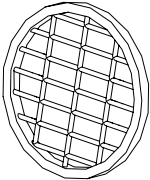
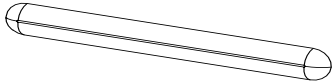
Item Number	Image Reference	Item Description	Part Number	Item Quantity
8		Ball Shut Off Assembly	913835	1
9		Separator Assembly	913837	1
10		Deck Buffer Kit	913838	1
11		Trim Glide	913839	2
12		Port Filter Disc	913840	5
13		Self Adhesive Domed Strip	913841	2
14		Replacement Hose	913828	1

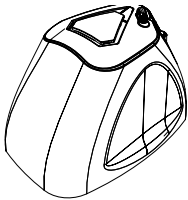
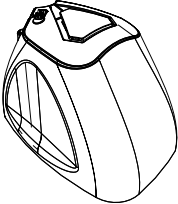
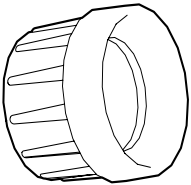
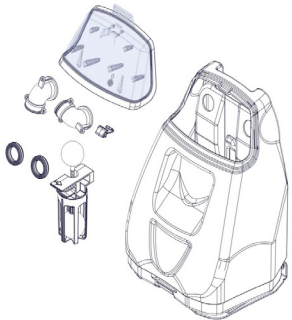
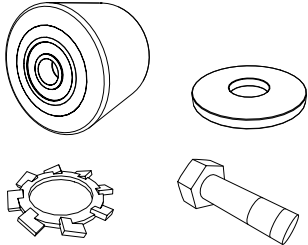
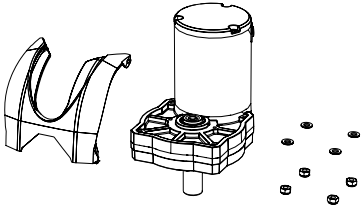
Item Number	Image Reference	Item Description	Part Number	Item Quantity
15		Left Motor Cover Moulding	913843	1
16		Right Motor Cover Moulding	913845	1
17		Hose Cuff	913846	1
18		Waste Water Tank Kit	913827	1
19		Rear Wheel Kit	914004	2
20		Brush motor Kit (Left or Right)	913990	1

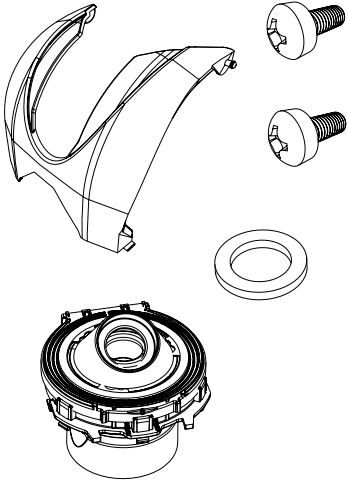
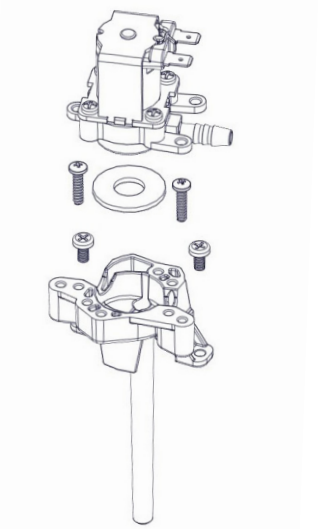
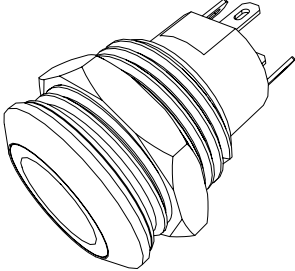
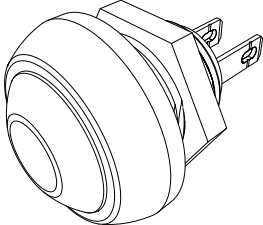
Item Number	Image Reference	Item Description	Part Number	Item Quantity
21		VAC Motor Kit	913992	1
22		Solenoid Kit (Left or Right)	913994	1
23		Handle VAC/Water Switch Kit	913996	1
24		Health & Safety Switch Kit	913998	1

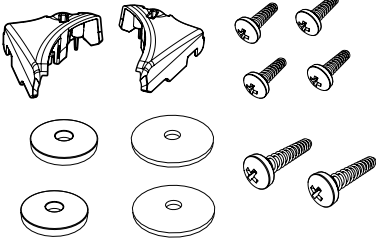
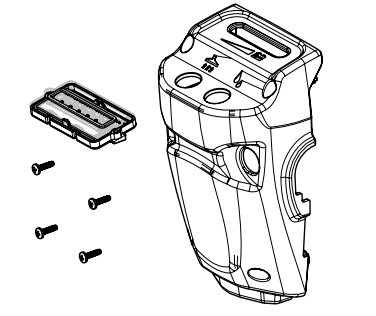
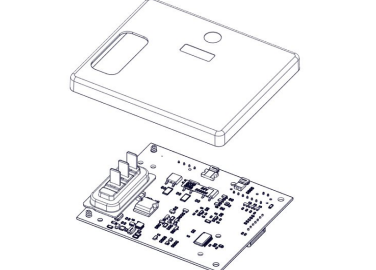
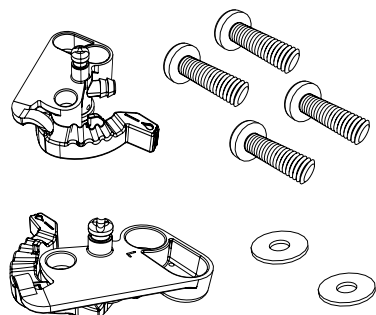
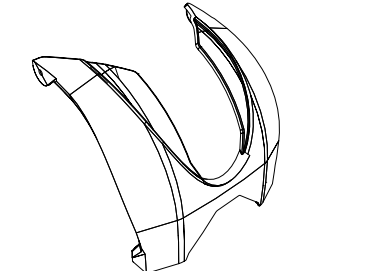
Item Number	Image Reference	Item Description	Part Number	Item Quantity
25		Deck Wing Kit	914000	1
26		Handle PCB Kit	914006	1
27		Battery/Control PCB Kit	914008	1
28		Tap Assembly Kit	914010	1
29		Center Cover Moulding	914002	1

Item Number	Image Reference	Item Description	Part Number	Item Quantity
30		Floor Tool Trap Moulding Kit	914144	1
31		Floor Tool Trap Clip	914143	1
32		Floor Tool End Caps (Left or Right)	914145	1
33		Blade Set (Front & Rear)	913810	1
34		Gasket Seal	914741	4

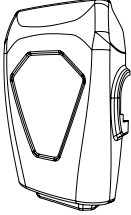
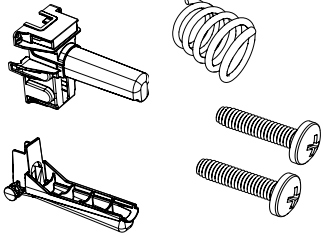
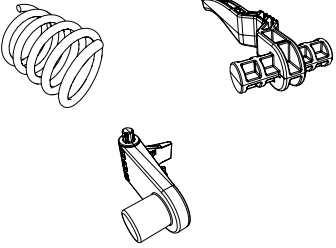
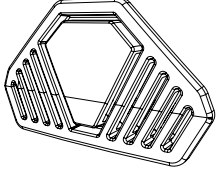
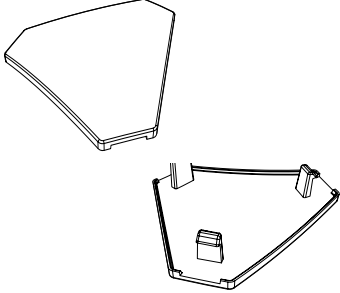
Item Number	Image Reference	Item Description	Part Number	Item Quantity
35		Handle Front Cover Moulding	914445	1
36		Handle Grip and Trigger Kit	914457	1
37		Handle Adjust and Release Control Kit	914447	1
38		Grill Moulding Kit	914444	1
39		Motor Vent Cover Kit	914455	2

Item Number	Image Reference	Item Description	Part Number	Item Quantity
40		Handle Tube Kit	914463	1
41		Motor Controller Right Kit	914449	1
42		Motor Controller Left Kit	914451	1
43		Replacement Tube Clip Kit	914452	4
44		Floor Tool Bracket Kit	914443	1

	UK		<p>Any maintenance operation is to be carried out in a safe environment All electrical work is to be carried out by a competent person Move tank assembly Retain all nuts, screws and washers for refitting (If applicable)</p>	
	DE		<p>Sämtliche Wartungsarbeiten sind in einer sicheren Umgebung durchzuführen Alle Elektroarbeiten sind durch eine entsprechend befähigte Person durchzuführen Bewegen Sie die Tankbaugruppe Bewahren Sie alle Muttern, Schrauben und Unterlegscheiben zum Wiedereinbau sicher auf (falls zutreffend)</p>	
	ES		<p>Toda operación de mantenimiento debe realizarse en un entorno seguro Todo trabajo eléctrico debe ser realizado por una persona competente Mover el conjunto de depósito Guardar todas las tuercas, tornillos y arandelas para volver a colocarlos (si corresponde)</p>	
	FI		<p>Kaikki huoltotoimenpiteet on suoritettava turvallisessa ympäristössä Ammattitaitoisen henkilön on tehtävä kaikki sähkötyöt Siirrä säiliöyksikkö Säilytä kaikki mutterit, ruuvit ja prikat asennusta varten (jos käyttökelpoisia)</p>	
	FR		<p>Toute opération d'entretien doit être effectuée dans un environnement sécurisé Tous travaux électriques doivent être assurés par du personnel qualifié uniquement Déplacez l'ensemble réservoir Conservez tous les écrous, vis et rondelles en vue d'un (éventuel) remplacement</p>	
	IT		<p>Tutti gli interventi di manutenzione devono essere effettuati in un ambiente sicuro Tutti gli interventi elettrici devono essere effettuati da personale competente Spostamento del gruppo serbatoio Conservare tutti i dadi, le viti e le rondelle per il rimontaggio (se applicabile)</p>	
	NL		<p>Alle onderhoudswerkzaamheden moeten worden uitgevoerd in een veilige omgeving Alle elektrische werkzaamheden moeten worden uitgevoerd door een bevoegd persoon Verplaats de hoofdtank Bewaar alle moeren, schroeven en sluitringen voor hermontage (indien van toepassing)</p>	
	PL		<p>Wszystkie czynności konserwacyjne należy wykonywać w bezpiecznym środowisku Wszelkie prace elektryczne powinna wykonywać osoba kompetentna Przesunąć zespół zbiornika Zachować wszystkie nakrętki, śruby i podkładki do ponownego montażu (jeżeli dotyczy)</p>	
	PT		<p>Qualquer operação de manutenção deve realizar-se num ambiente seguro Todo o trabalho elétrico deve ser realizado por um técnico qualificado Mover o depósito principal Guardar todas as porcas, parafusos e anilhas para reinstalar (se aplicável)</p>	
	SV		<p>Alla former av underhåll ska utföras i en säker miljö Allt elektriskt arbete ska utföras av en behörig person Flytta tankenheten Behåll alla muttrar, skruvar och brickor för reparation (om det är tillämpligt)</p>	

