



HDS-E 8/16-4 M Service Manual



1	Preface	5
2	Safety instructions	5
	2.1 Hazard levels.	5
	2.2 General notes on safety	5
3	Technical Features	5
	3.1 General	5
	3.2 Connection performance of appliance.	5
	3.3 Electrical/electronics	5
	3.4 Drive	5
	3.5 High-pressure pump	5
	3.6 Boiler	6
	3.7 Cleaner	6
	3.8 Accessories	6
4	Parts of the system	7
	4.1 Front view	7
	4.2 Rear view	8
	4.3 View from below	9
	4.4 Storage compartments	10
	4.4.1 Folding compartment	10
	4.4.2 Storage compartment	10
	4.4.3 Type plate.	10
	4.5 View of the right side, appliance hood open	11
5	Function	12
	5.1 Operator console.	12
	5.1.1 Indicator lamps	13
	5.2 Interior of operating panel	15
	5.2.1 Open the operating panel.	15
	5.2.2 Operating panel open.	16
	5.2.3 Control electronics	17
	5.3 Cover.	19
	5.3.1 Open the device hood.	19
	5.3.2 Remove the appliance cover	19
	5.4 Service switch	20
	5.4.1 Setting up water hardness	20
	5.4.2 Service position	20
	5.5 System care RM 110/RM 111	21
	5.5.1 Ventilating the reciprocating pump	22
	5.5.2 System care with RFID.	22
	5.6 Boiler	23
	5.6.1 Remove the boiler cover	24
	5.6.2 Boiler models	25
	5.6.3 Overflow	26
	5.6.4 Water shortage safeguard	26
	5.6.5 Temperature sensor	26
	5.6.6 Temperature controller	26

5.6.7	Protective conductor connection	26
5.7	Detergent.	27
5.7.1	Detergent Tank	27
5.7.2	Filter detergent hose	27
5.7.3	External suction	27
5.8	High-pressure pump	28
5.8.1	Sectional illustration	31
5.8.2	High pressure seal / low pressure seal	32
5.8.3	Electric box 12 kW	33
5.8.4	Electric box 24 kW	34
5.8.5	Electric box 36 kW	35
5.9	Hand spraygun	36
5.10	Rotating regulator	37
5.11	Functional diagram	38
5.12	Pressure and volume regulation	40
5.12.1	Pressure and quantity regulation at the pump	41
5.12.2	Rotating regulator on the hand spray gun	41
5.12.3	Gun closed	41
5.13	Functional description of pressure switch	42
5.13.1	Appliance is switched off	42
5.13.2	The appliance is switched on and the gun is open.	43
5.13.3	Gun is closed	44
5.13.4	The gun is reopened when the appliance is switched on.	45
5.14	Functional description of the control	46
5.14.1	Hot water/cold water solenoid valves	46
5.14.2	Water shortage safeguard	46
5.14.3	Heating	46
5.14.4	Reciprocating pump (system care).	46
6	Basic settings and service procedures	47
6.1	Service functions with display	47
6.1.1	Activating the service function	47
6.1.2	Changing the settings.	48
6.1.3	Terminating the service function.	48
6.1.4	Overview of the service functions.	48
6.1.5	Set up the switching off process.	49
6.1.6	Set up the leakage behaviour.	49
6.1.7	Check the indicator lamps	49
6.1.8	RFID query	50
6.1.9	Check the temperature sensor.	51
6.1.10	Check the thermostat and the device switch	52
6.1.11	Check the service switch	54
6.1.12	Sensoren prüfen.	55
6.1.13	Error memory	56
6.1.14	System care consumption	58
6.1.15	Gun switches since the most recent gun service.	59
6.1.16	Gun services	60
6.1.17	Gun switches since initial startup	61

6.1.18	Operating hours of the heater since heater service	62
6.1.19	Heater service	63
6.1.20	Operating hours of the heater since the startup of the device	64
6.1.21	Operating hours of the pump since pump service	65
6.1.22	Pump services	66
6.1.23	Operating hours of the pump since the start up of the device	67
6.1.24	Overview of a quick check of the device status	68
6.1.25	Maintenance intervals	69
6.2	Adjust the rotating regulator on the pump	70
6.2.1	Setting the maximum working pressure	70
6.2.2	Setting the minimum working pressure	71
6.3	Remove the manometer	72
6.4	Adjust safety valve	73
6.5	Remove the pump kit	74
6.6	Disassemble the high pressure pump.	75
6.6.1	Remove the pump head.	75
6.6.2	Remove the piston guide and replace the oil seals	76
6.6.3	Low pressure seal packages	77
6.6.4	Replace high pressure seals	78
6.6.5	Remove the suction jumper, replace the seals and the suction valves	78
6.6.6	Remove the high pressure valves.	79
6.7	Replace the water fine filter.	79
6.8	Decalcify boiler.	80
6.9	Remove boiler	81
6.9.1	Information for the assembly	82
6.10	Removing the heating element	83
6.10.1	Information for the assembly	83
6.11	Remove the rotary switch	84
6.11.1	Remove the device switch	84
6.11.2	Removing the thermostat	84
7	Troubleshooting	85
7.1	Fault display via indicator lamps	85
7.2	Appliance is not running	85
7.3	Device is not building up pressure	85
7.4	Device leaks, water drips from the bottom of the device.	85
7.5	Device turns on and off while hand spray gun is closed	85
7.6	Device is not sucking in detergent.	85
7.7	Boiler does not heat up	85
7.8	Set temperature is not achieved while using hot water.	85
8	Technical specifications.	86
9	Special tools	87
10	Torques	88
11	Circuit diagrams	89
12	Cut-out masks to place on the operating panel.	92

1 Preface

Good service work requires extensive and practice-oriented training as well as well-structured training materials.

Hence we offer regular basic and advanced training programmes covering the entire product range for all service engineers.

In addition to this, we also prepare service manuals for important appliances - these can be initially used as instruction guides and later on as reference guides.

Apart from this, we also regular information about product enhancements and their servicing.

If you should require supplements, have corrections or questions regarding this document, please address these citing the following subject to:
international-service@de.kaercher.com

Subject:	Fall 112070
----------	--------------------

The responsible product specialist will take care of your issue.

Copying and duplication of texts and diagrams as well as third-party access to this information is permitted only with the explicit permission of the company:

Alfred Kärcher GmbH & Co. KG
P O Box 160
D -71349 Winnenden
www.kaercher.com

2 Safety instructions

2.1 Hazard levels

⚠ Danger

Immediate danger that can cause severe injury or even death.

⚠ Warning

Possible hazardous situation that could lead to severe injury or even death.

Caution

Possible hazardous situation that could lead to mild injury to persons or damage to property.

2.2 General notes on safety

⚠ Warning

Prior to opening the electric box, all power to the appliance must be shut off (pull mains plug) and it must be protected from inadvertent startup.

3 Technical Features

3.1 General

Mobile hot water high pressure cleaner in different performance classes for commercial use.

- Electrically heated boiler
- Water supply with coarse dirt filter and fine filter from the boiler
- Float valve in the boiler
- Built-in calcification protection
- Hourmeter built into the control electronics
- Crane suspension can be added later
- Hose drum cannot be upgraded
- Cable remote control cannot be upgraded
- SB module cannot be upgraded

3.2 Connection performance of appliance

- HDS-E 8/16-4M 12kW: 17,5 kW
- HDS-E 8/16-4M 24kW: 29,5 kW
- HDS-E 8/16-4M 36kW: 41,5 kW

3.3 Electrical/electronics

- Control electronics
- Power switch
- Two pressure switches
- Water temperature regulation with temperature sensor
- Water shortage safeguard
- Dry-run protection for pump and heating element
- Temperature controller heating element
- Dimensioning of cables and contactors as per heating output
- Level sensor for system care RM 110/111 and lack of oil
- Component tests
- Fault monitoring and fault display

3.4 Drive

- 4-pin water and air-cooled electric motor
- Motor with winding protection

3.5 High-pressure pump

- 3 piston axial pump, piston with ceramic coating
- Piston (d=18 mm) without piston shoes
- Pump head made of brass
- Suction and high pressure valves made of plastic or stainless steel
- Swash plate with axial ball bearing
- Manometer
- Overflow valve with pressure and quantity regulation
- Working pressure: 165 bar
- Water quantity: 710 - 760 l/h
- Safety valve

3.6 Boiler

- Dosing of system care RM 110/111 with RFID system
- Heating element output 12/24/36 kW
- Quick heating chamber (12 kW model)
- Thermal insulation

3.7 Cleaner

- 2 detergent tanks
- Content of detergent tank 1: 10 l
- Content of detergent tank 2: 20 l
- Detergent dosing valve on the device with automatic clear rinse in zero position.

3.8 Accessories

- Rotary regulator for pressure and quantity regulation
- Soft grip - easy press gun
- Power nozzle (stainless steel)
- High pressure hose

4 Parts of the system

4.1 Front view



- 1 Handle
- 2 Closing flap for storage compartment
- 3 Safety latch of the hand spray gun
- 4 Pressure and quantity regulation at the hand spray gun
- 5 Lever for hand spray gun
- 6 Trigger gun
- 7 Spray lance

- 8 High pressure hose
- 9 High-pressure nozzle (stainless steel)
- 10 Bearing wheel
- 11 Mounting location for transport
- 12 Steering roller with fixed position brake
- 13 Chassis
- 14 Cover
- 15 Cover lock

The detergent tanks are integrated into the chassis and cannot be replaced separately.

4.2 Rear view



- | | | | |
|---|-----------------------------------|----|---|
| 1 | Indicator lamps | 10 | High pressure connection |
| 2 | Power switch | 11 | Connection for water supply with filter |
| 3 | Temperature controller | 12 | Step depression |
| 4 | Storage spray pipe | 13 | Power supply |
| 5 | System care Advance RM 110/RM 111 | 14 | Pouring vent for detergent 1 |
| 6 | Hose hook | 15 | Cable hook |
| 7 | Folding compartment | 16 | Dosage valve for detergent |
| 8 | Pouring vent for detergent 2 | 17 | Manometer |
| 9 | Chassis | 18 | Closing flap for storage compartment |

4.3 View from below

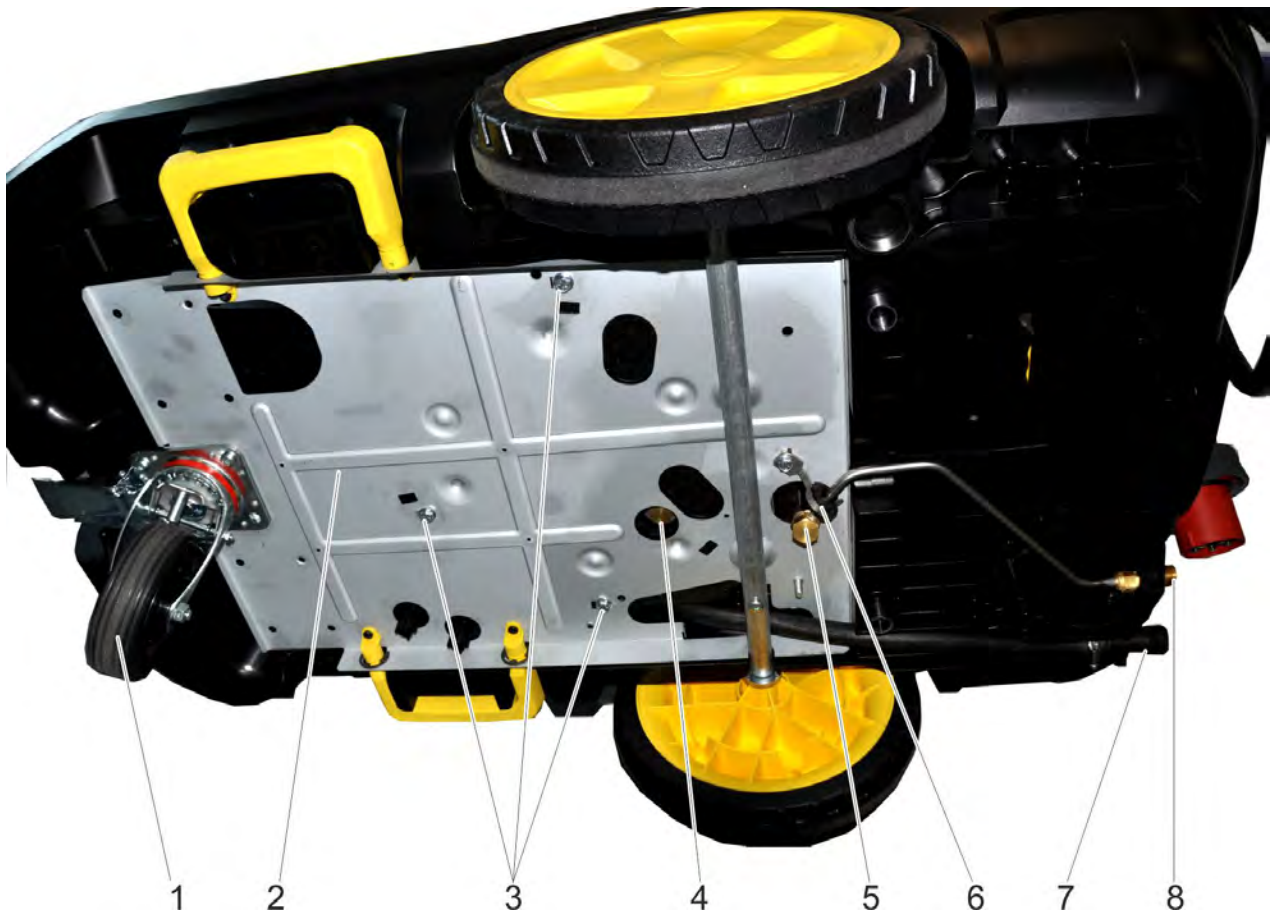

- 1 Guiding roll with fixed position brake
- 2 Floor plate
- 3 Boiler fastening screws
- 4 Boiler drain screw
- 5 High pressure line
- 6 High pressure line bracket
- 7 Connection for water supply with filter
- 8 High pressure connection

Note

The floor plate is intended to reinforce the chassis and as a base plate for the boiler.

4.4 Storage compartments

4.4.1 Folding compartment



- 1 Bottle holder for cylindrical bottles
- 2 Handle
- 3 Bottle holder for two RFID system care bottles

4.4.2 Storage compartment



- 1 Device documentation
- 2 Storage for rotor nozzle
- 3 Screw for storage compartment
- 4 Storage for high-pressure nozzle
- 5 Screw for operating panel
- 6 Storage compartment for accessories
- 7 Boiler fastening screw

4.4.3 Type plate

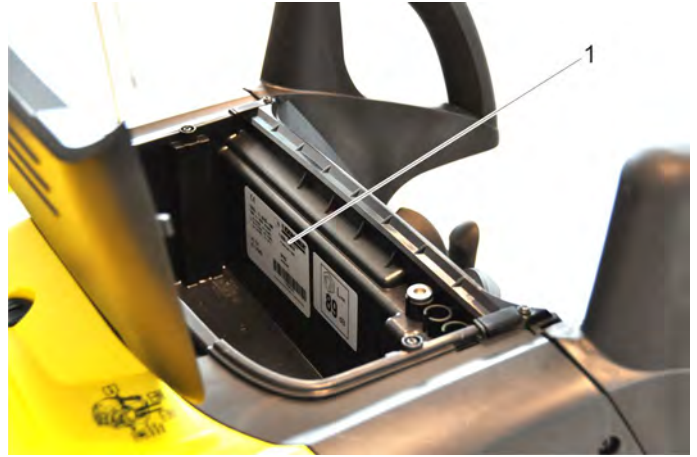

- 1 Nameplate

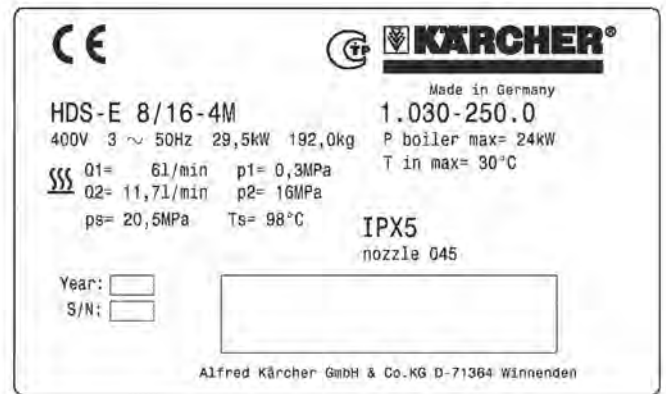

4.5 View of the right side, appliance hood open



- | | |
|---|---|
| 1 Boiler | 9 Suction hose for detergent |
| 2 Low-pressure hose motor cooling to the boiler | 10 High pressure hose between pump and safety valve |
| 3 Fine filter (water) | 11 System care hose |
| 4 Electric box, motor | 12 Safety valve |
| 5 Oil tank | 13 Service switch |
| 6 High-pressure pump | 14 System care Advance RM 110/RM 111 |
| 7 Solenoid valve for cold water | |
| 8 Solenoid valve for warm water | |

5 Function



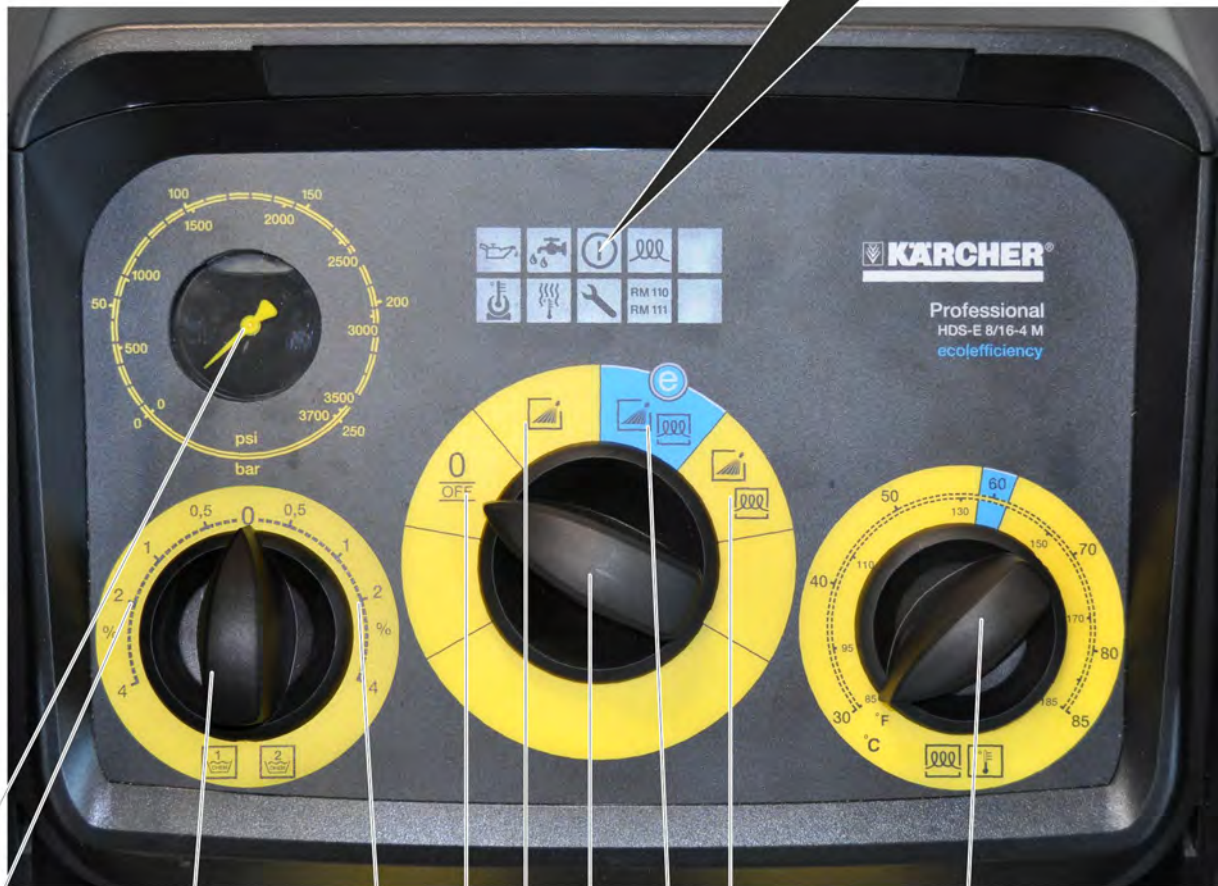
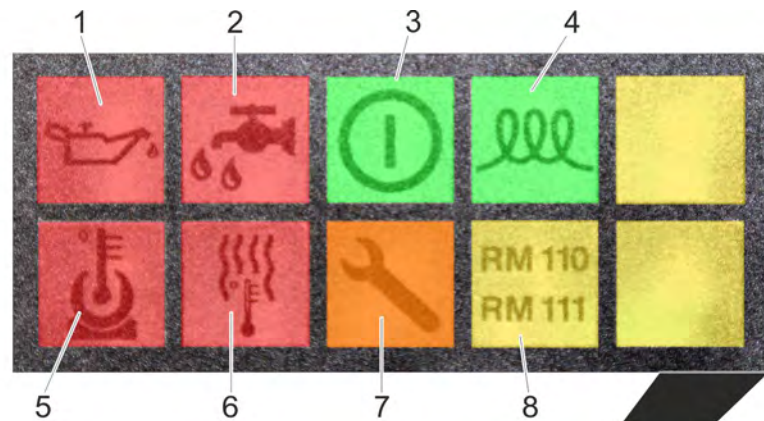



5.1 Operator console



- 1 Indicator lamp for pump, red
- 2 Indicator lamp "water shortage" red
- 3 "Ready for use" indicator lamp, green
- 4 Indicator lamp - heating, green
- 5 Indicator lamp for motor, red
- 6 Indicator lamp boiler fault, red
- 7 Indicator lamp - service, orange
- 8 Indicator lamp system care, yellow

- 9 Manometer
- 10 Dossing range of detergent tank 1
- 11 Dosage valve for detergent
- 12 Dossing range of detergent tank 2
- 13 0/OFF
- 14 Operating with cold water
- 15 Power switch
- 16 Eco! efficiency setting (hot water max. 60 °C)
- 17 Operating with hot water
- 18 Temperature controller

5.1.1 Indicator lamps

Indicator lamp	Activity	Meaning / measure
	blinks once	<ul style="list-style-type: none"> - Oil shortage pump → Replenish oil.
	blinks twice	<ul style="list-style-type: none"> - Leak in the high pressure system → Check high pressure system and connections for tightness.
	blinks thrice	<ul style="list-style-type: none"> - Lack of water, the pump is switched off to prevent dry runs after a 2 minute delay. → Check water supply, check connections.
	blinks four times	<ul style="list-style-type: none"> - Pump and heater switch off, fault in auxiliary relay of heater → Set the appliance switch to "0/OFF". → Turn on the appliance. - Error occurs repeatedly. → Recheck the auxiliary relay of the heater K5, replace.
	glow	<ul style="list-style-type: none"> - Lack of water in the boiler - heater is switched off → Check water connection, check water supply.
	glow	The appliance is now ready for operation.
	blinks once	Either the device was in continuous operation for 30 minutes or in standby mode for 30 minutes. Pump and heater are switched off.
	glow	Heater is switched on.
	blinks twice	<ul style="list-style-type: none"> - Engine overloaded/overheated, winding protective contact open → Set the appliance switch to "0/OFF". → Allow device to cool down. → Turn on the appliance. - Error occurs repeatedly. → Ascertain the cause for the overheating and rectify it.
	blinks thrice	<ul style="list-style-type: none"> - Fault in the voltage supply (low voltage, overvoltage, phase failure). → Check main connections and mains fuse.
	blinks four times	<ul style="list-style-type: none"> - Current pickup too high or asymmetric current pickup. → Check main connections and mains fuse. → Check the motor and the pump for ease of operation.
	blinks once	<ul style="list-style-type: none"> - Temperature limiter in the boiler was triggered → Set the appliance switch to "0/OFF". → Allow boiler to cool down. → Turn on the appliance. - Error occurs repeatedly. → Check the temperature limiter, the temperature sensor and the heating element for calcification.
	blinks thrice	<ul style="list-style-type: none"> - System care detection defective → Check/replace the RFID electronics.
	blinks four times	<ul style="list-style-type: none"> - Temperature sensor defective (broken cable, short circuit). → Check / replace the temperature sensor.

Indicator lamp	Activity	Meaning / measure
	glow	<ul style="list-style-type: none"> - Maintenance due ➔ Read the necessary maintenance tasks from the control system and perform them.
<div style="background-color: yellow; border: 1px solid black; padding: 2px; width: fit-content;"> RM 110 RM 111 </div>	glow	<p>Note: Heater can only operate 5 more hours.</p> <ul style="list-style-type: none"> - System care tank is empty or units on the RFID tag are used up (see "System care with RFID"). ➔ Replace the system care bottle.
	blinks once	<p>Note: Heater operation no longer possible.</p> <ul style="list-style-type: none"> - System care bottle empty. ➔ Replace the system care bottle.

5.2 Interior of operating panel

5.2.1 Open the operating panel

⚠ Danger

Danger of injury by electric shock.

Prior to opening the operating panel, all power to the device must be shut off (pull mains plug) and it must be protected from inadvertent startup.



1 Closing flap for storage compartment

2 Screw

- ➔ Open the covering flap of the storage compartment.
- ➔ Unscrew the screws and open the electric box toward the front.

5.2.2 Operating panel open

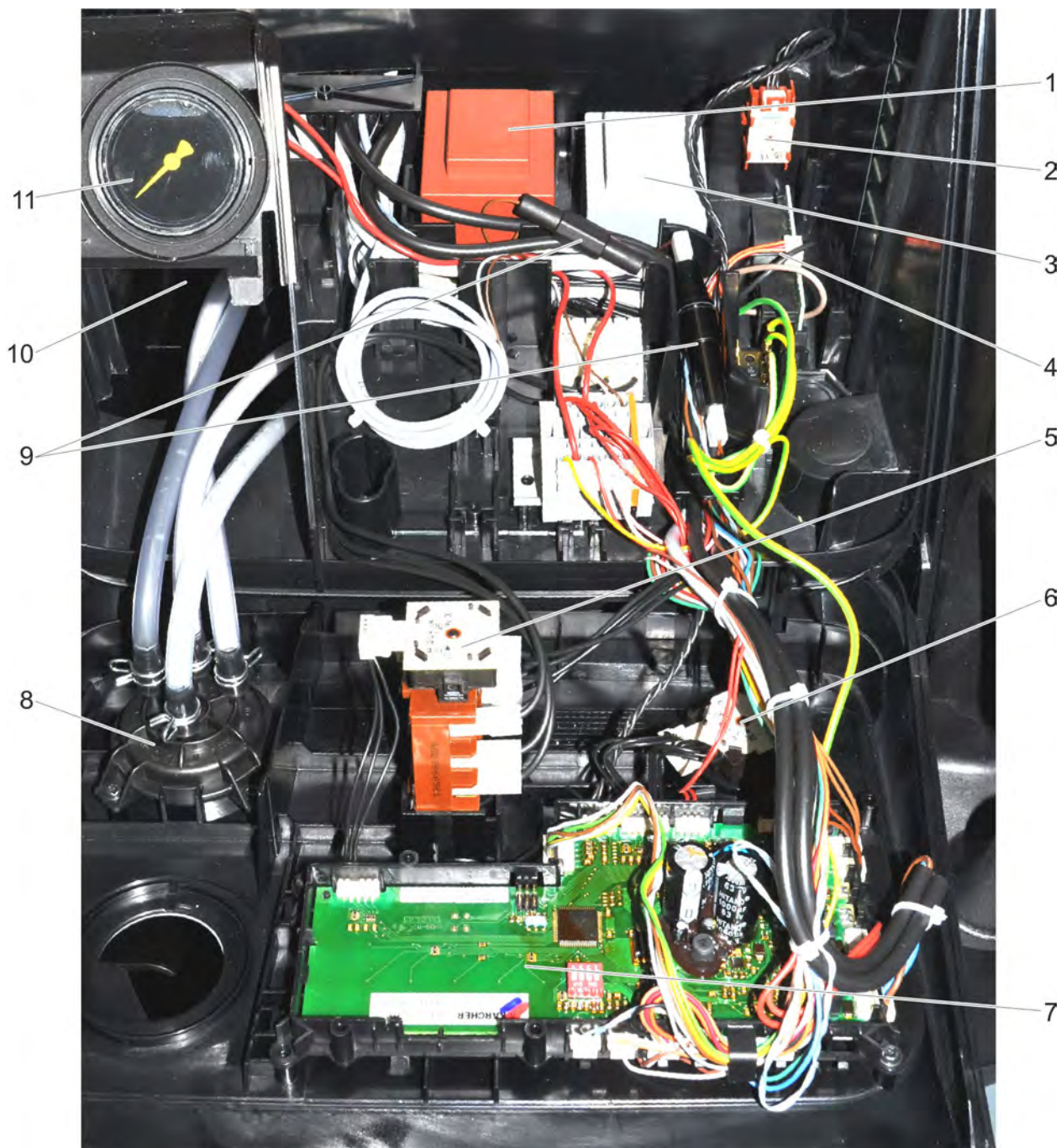

1 Control transformer T1

2 Service switch

3 Control transformer T2

4 Transducer

5 Power switch

6 Temperature controller

7 Control electronics

8 Dosage valve for detergent

9 Control transformer fuse

10 Temperature limiter (behind pressure gauge)

11 Manometer

5.2.3 Control electronics

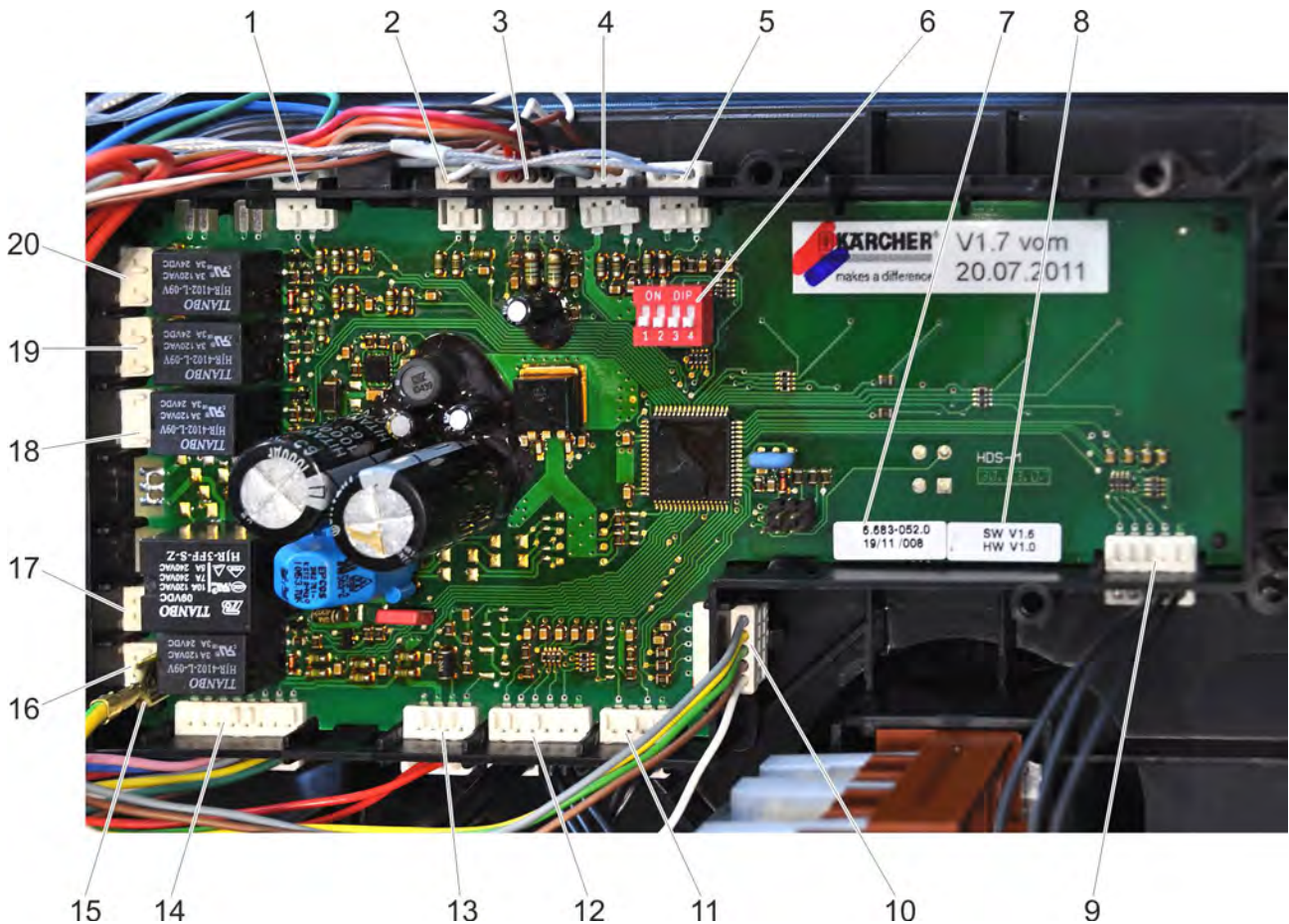

- 1 Temperature limiter connection/K5
- 2 Connection of level sensor for system care
- 3 Transducer connection
- 4 Connection, lack of water protection
- 5 Temperature sensor connection
- 6 DIP switch
- 7 Part number, week of manufacture, year of manufacture, serial number
- 8 software: Softwareversion
HW: Hardware version
Start of series: SW V1.8, HW V1.0
- 9 Device switch connection
- 10 RFID electronics connection
- 11 Service switch connection
- 12 Connection of thermostat
- 13 Auxiliary relay K4 connection, lack of water
- 14 PCB motor distributor connection
- 15 Grounding connection of control electronics
- 16 Control transformer T1 connection
- 17 Control transformer T2 connection
- 18 Auxiliary relay K5 connection, temperature limiter
- 19 Solenoid valve connection for cold water
- 20 Solenoid valve for warm water connection

Version numbers of software and hardware

The version numbers of the software (SW) and the hardware (HW) are indicated on the electronics. The plugs for the PCB connections are designed with encoding pins and their matching recesses in the PCB base so that only the matching plug can be attached to the respective connection.

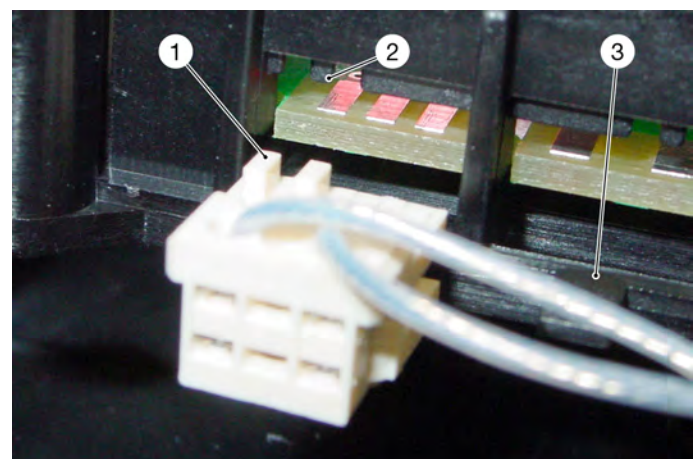

- 1 Encoding pin
- 2 Recess for encoding pin
- 3 Lock for plug

DIP switch

DIP	Adjustment by the manufacturer:	Function
1	OFF	-
2	OFF	-
3	OFF	No pump trailing *
4	OFF	Dosing of system care RM 110/111 for water volumes of less than 1,000 l/h

Caution

Severe reduction of the pump idle time. Do not activate the pump trailing.

5.3 Cover

5.3.1 Open the device hood.

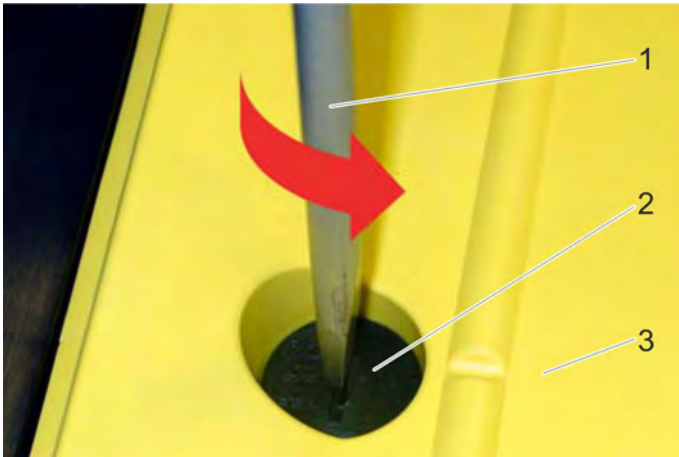

- 1 Screwdriver
- 2 Locking
- 3 Cover

- Press the latch down using a screwdriver or a coin and turn it by 90° counter-clockwise.
- Open the device hood.

5.3.2 Remove the appliance cover

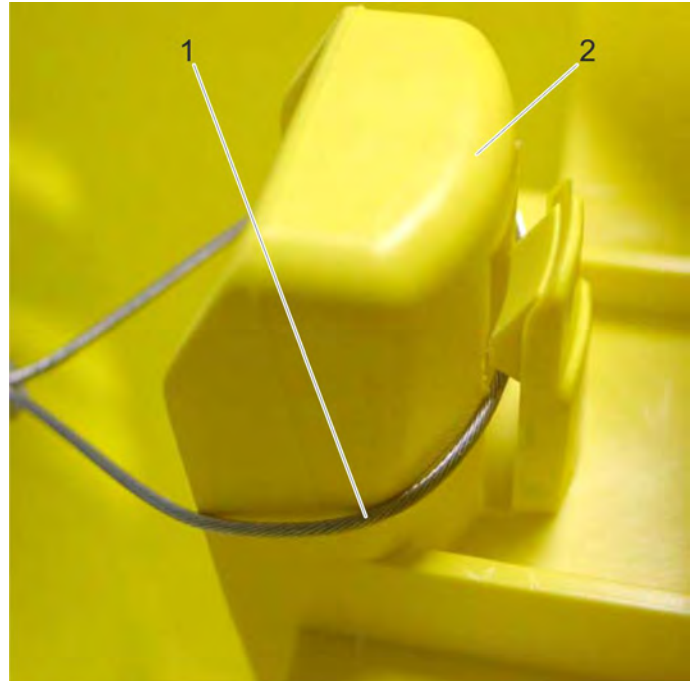

- 1 Wire rope
- 2 Support

- Unhook the wire rope.

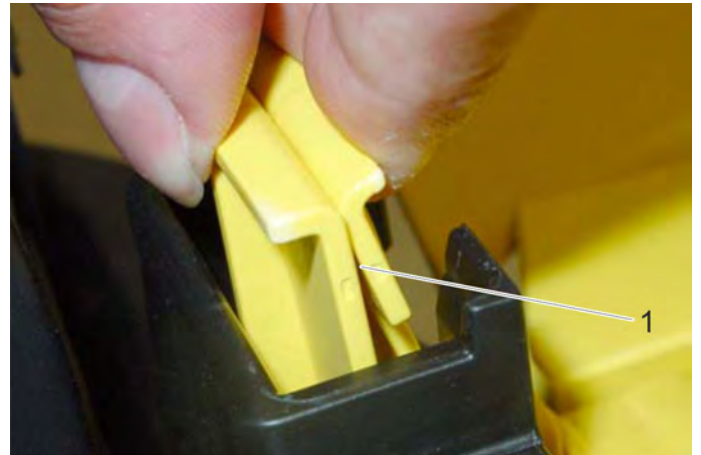

- 1 Hinge

- Unclip the hinge clamp and slide it out toward the top.
- Remove the appliance cover.

5.4 Service switch



- 1 Service switch
- 2 Arrow
- 3 "OFF" position
- 4 Service position
- 5 SET position

5.4.1 Setting up water hardness

The water hardness must be set at the site to be able to correctly meter the system care (RM 110/RM 111).

➔ Determining the hardness of tap water:

- Through the public water supply works.
- Measure the water using the water hardness testing set, order no. 6.768-004.0.

➔ Set the service switch according to the water hardness in the table.

Degree of hardness	Water hardness [°dH]	Service switch setting
very soft	<3	OFF
soft	3,1...7,0	1
medium	7,1...14	2
hard	14,1...21,0	3
very hard	>21,0	4

5.4.2 Service position

All device settings can be modified using the service setting. This function is described in the chapter "Service functions".

5.5 System care RM 110/RM 111

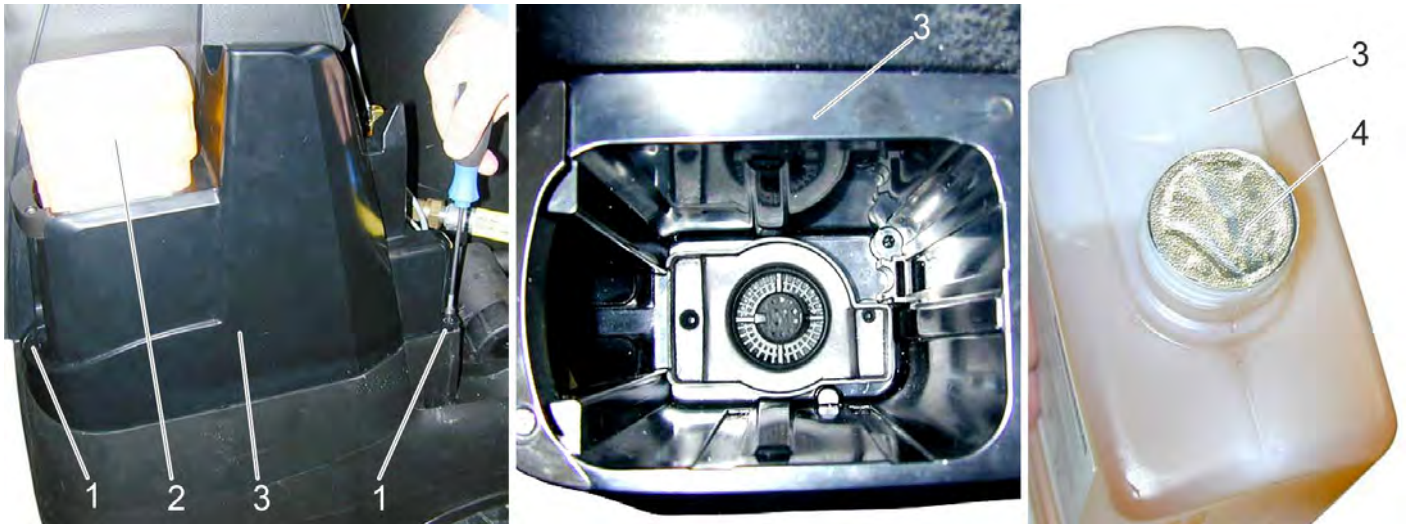

- 1 Screw
- 2 System care bottle
- 3 Holder for system care bottle with RFID electronics
- 4 System care bottle seal

The dosing of the system care takes place via a reciprocating pump.
The setting of the service switch determines the dosing volume.

Prerequisites for the dosing:

- Device switch is set to "Eco!Efficiency" or hot water operation.
- Water temperature of more than 50 °C

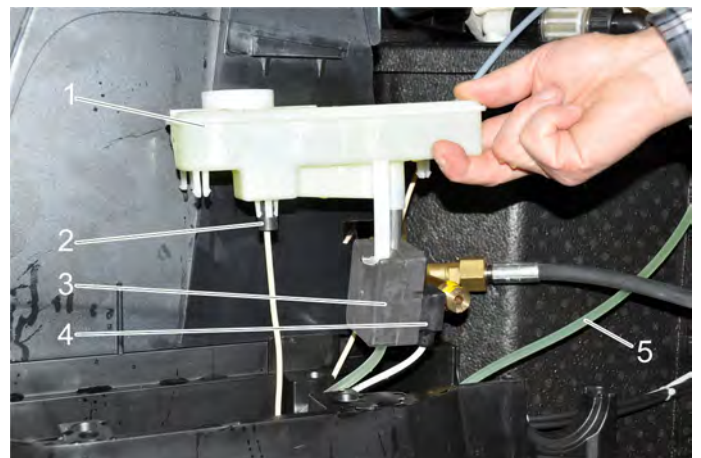

- 1 System care tank
- 2 Level sensor
- 3 Reciprocating pump
- 4 Plug
- 5 Hose to the boiler

The system reports the system care empty via:

- the level sensor in the system care tank
 - RFID electronics/tag on the system care bottle
- After the empty message, you can keep working with hot water operation for another 5 hours. After that, the heater operation is blocked until a new system care bottle is installed.

The dosing system works with vacuum pressure. If the system care bottle is damaged or drilled open, it will be empty in a short time.

During heating operation with water with calcium content without system care RM 110/111 you must expect failures due to calcification.

Note

The sealing of the container must not be removed; it is opened automatically when it is pressed into the intake.



- 1 System care tank
- 2 Ferrite core for interference suppression of the reciprocating pump

5.5.1 Ventilating the reciprocating pump

- Note the service switch setting.
- Turn on the appliance.
- Set the thermostat to 85 °C.
- Open the hand spray gun and let the device run.
- Rotate the service key into the SET position and hold it there until the pump feeds evenly.
- Turn off the appliance.
- Rotate the service switch back into its original position.

5.5.2 System care with RFID

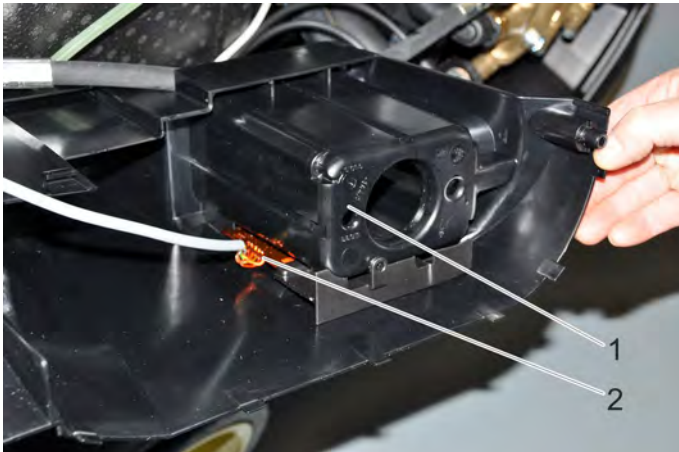

- 1 System care bottle holder
- 2 RFID electronics

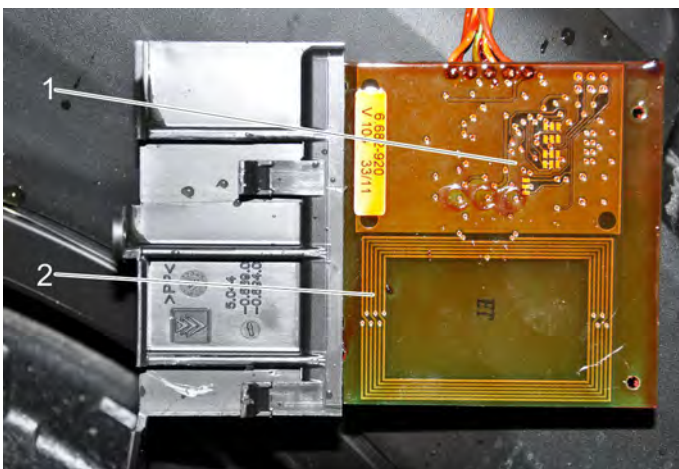

- 1 RFID electronics
- 2 Antenna

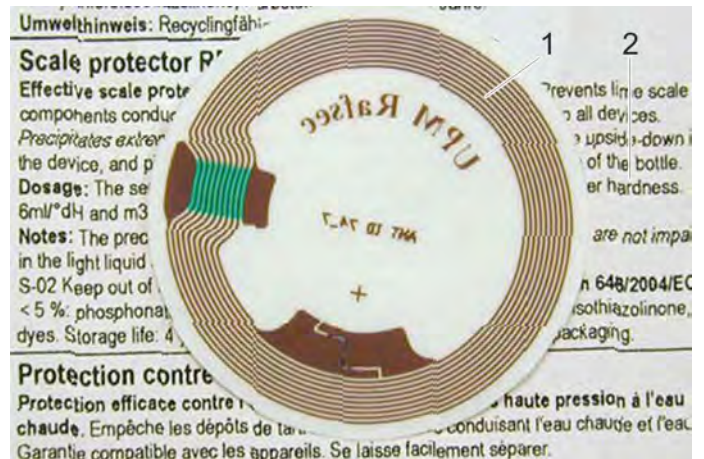

- 1 RFID tag, under the label
- 2 Decal of the system care bottle

RFID functionality

RFID stands for Radio Frequency Identification. There is a microchip with an antenna under the decal on the system care bottle, also called a tag. The write/read electronics inside the appliance can read data from the tag and also write data to the tag. The power supply is sent to the tag from the radio frequency field. The write/read electronics query the type of detergent and saves the dosed units to the tag. When the bottle is depleted after 3,000 units or when the level switch in the system care container announces depletion, a trailing time of 5 hours is started. This trailing time is counted on the tag. Once the trailing time has elapsed or if the empty bottle is removed, the heating operation is switched off. Once a bottle has been detected to be empty, it is blocked electronically and can no longer be used. Therefore, you must insert a new original system care bottle.

5.6 Boiler

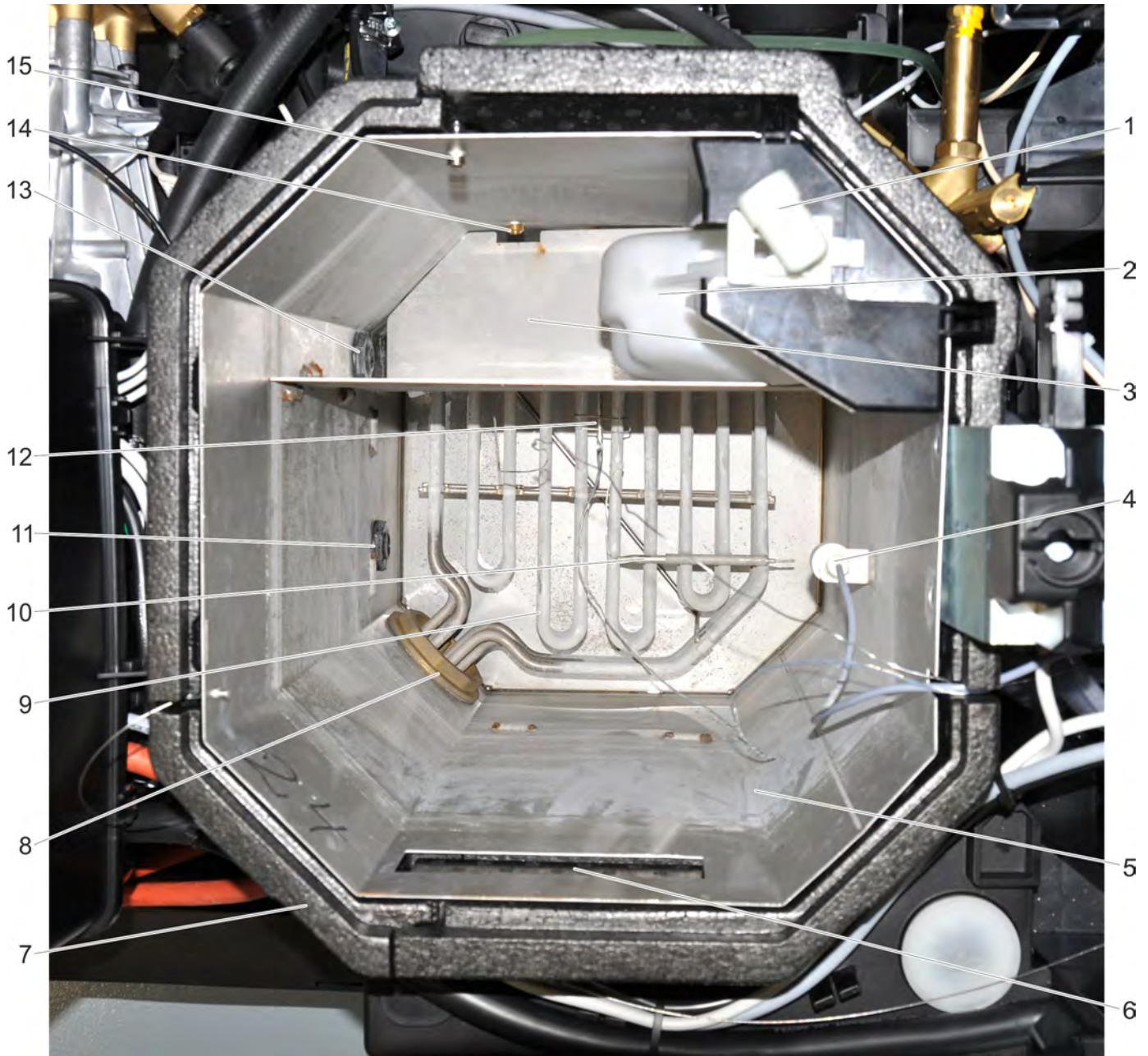

- 1 Water inlet
 - 2 Float
 - 3 Cold water tank
 - 4 Water shortage safeguard
 - 5 Warm water tank
 - 6 Overflow
 - 7 Thermal insulation
 - 8 Flange, heating element
 - 9 Heating element (24 kW)*
 - 10 Sensor of the temperature limiter
 - 11 Hot water outlet
 - 12 Temperature sensor
 - 13 Cold water outlet
 - 14 Rinse line outlet to the detergent dosing valve
 - 15 System care inlet
- *The heating elements differ in form and appearance according to the heating performance.

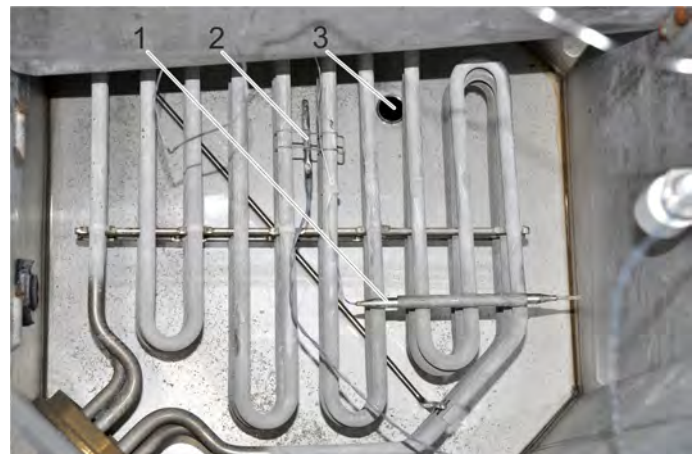

- 1 Temperature limiter
- 2 Temperature sensor
- 3 Drain screw



- 1 Cold water outlet
- 2 Hot water outlet

The boiler is divided into a cold and hot water reservoir by a removable sheet metal part. The water runs into the cold water reservoir via a float valve and is then transferred to the hot water reservoir.

5.6.1 Remove the boiler cover

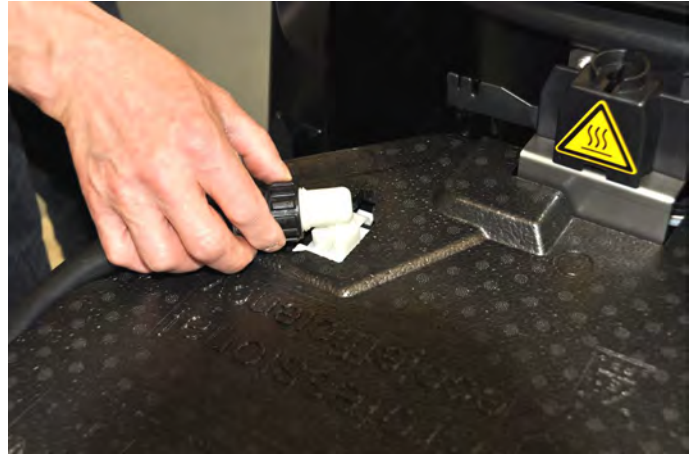

Unscrew the covering nut.



Remove the heat insulation.



Remove the covering plate.

5.6.2 Boiler models

There are three boilers with different heating outputs:

- 12 kW
- 24 kW
- 36 kW

The models with 24 kW and 36 kW differ only in their heating element. These models are pictured in the Chapter "Boiler".

The model with a heating output of 12 kW has an additional quick heating chamber and is described in the following.

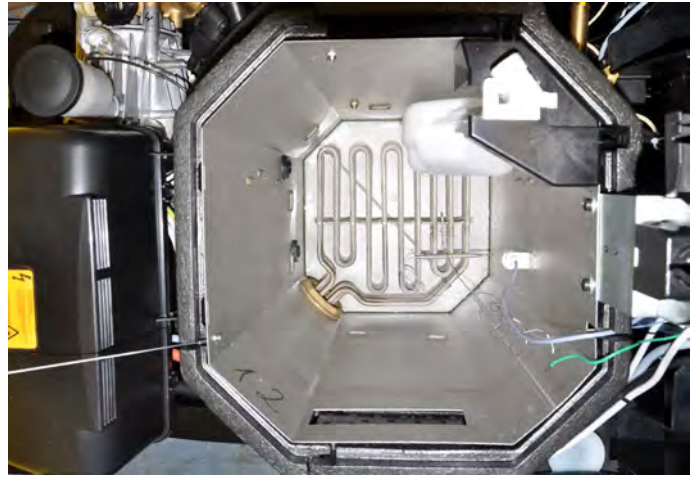

Boiler 12 kW without separator wall and quick chamber heating cover

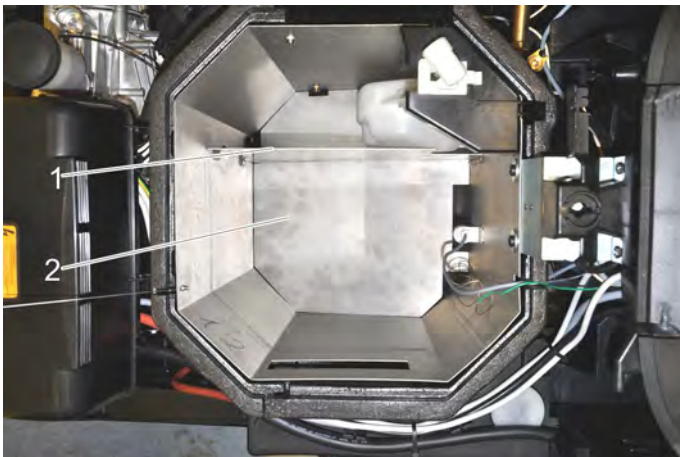

- 1 Separator wall between hot water/cold water reservoirs
- 2 Cover of quick heating chamber



Remove the separator wall

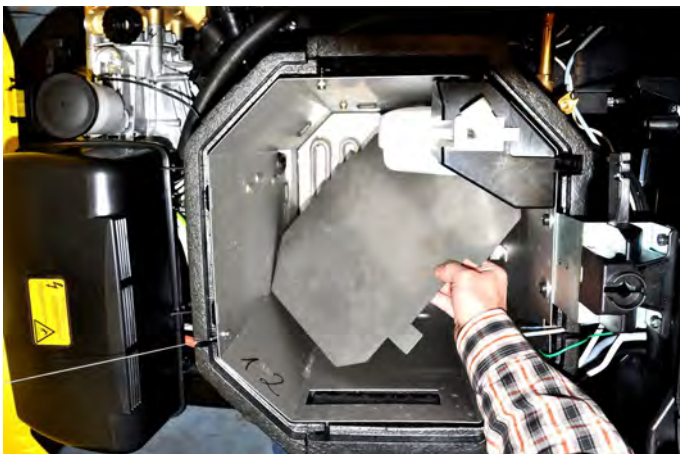

Remove the cover of the quick heating chamber (12 kW model only)

5.6.3 Overflow



- 1 Thermal insulation
- 2 Overflow, movable lid in the insulation

In case of failure of the float valve, the water exits from the boiler via the overflow. The flap of the heat insulation is opened by the stream of water.

Note:

The flap reduces heating loss in the boiler. Also, the exiting of water vapors that condense inside the device and can lead to damage, is prevented.

5.6.4 Water shortage safeguard

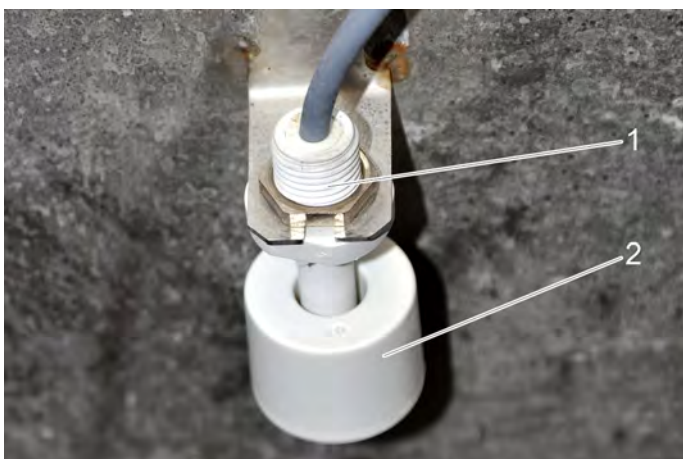

- 1 Water shortage safeguard
- 2 Float

The lack of water fuse prevents the heating element from being switched on when there is a water shortage.

5.6.5 Temperature sensor

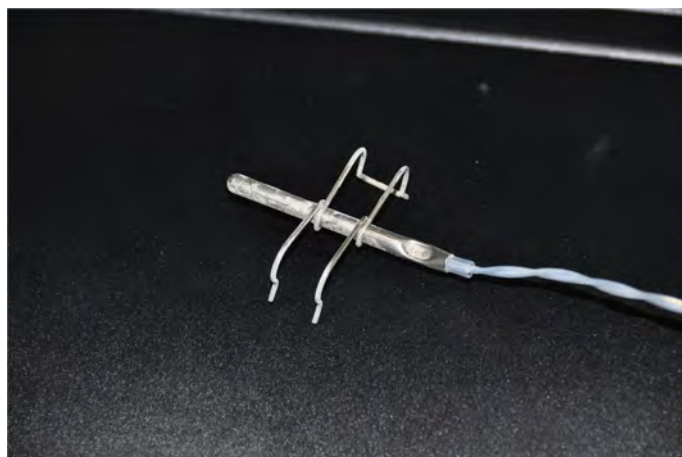

The control electronics captures the hot water temperature via the temperature sensor and switches the heating elements off or on as needed.

5.6.6 Temperature controller

If the temperature regulation via the control electronics fails, the temperature limiter switches the heating element off if the maximum temperature is exceeded.

Reset the temperature limiter:

Switch on/off the device switch again.

5.6.7 Protective conductor connection

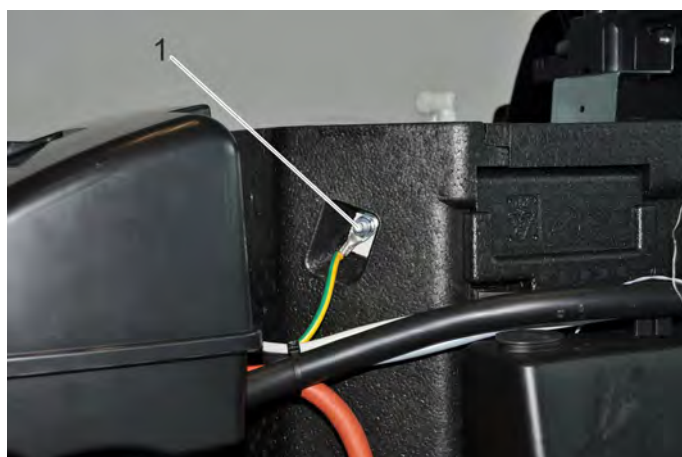

- 1 Connection, protective conductor

5.7 Detergent

5.7.1 Detergent Tank

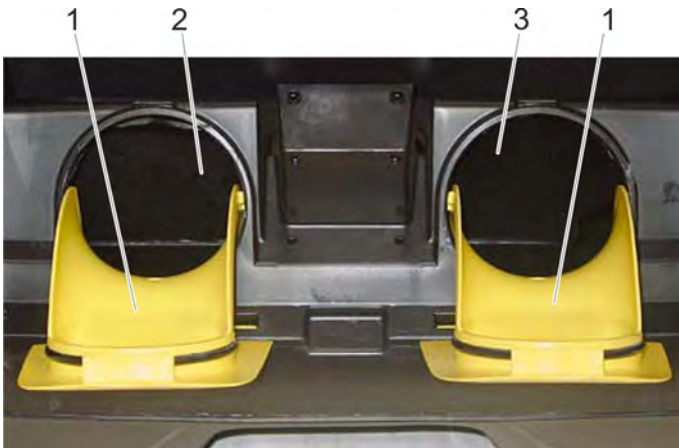

- 1 Detergent tank lid
- 2 Pouring vent for detergent 1
- 3 Pouring vent for detergent 2

The fill openings of the detergent tanks are located below the operating panel.



- 1 Suction hose for detergent 1
- Note: The boiler is not installed in the photograph.



- 1 Suction hose for detergent 2

5.7.2 Filter detergent hose

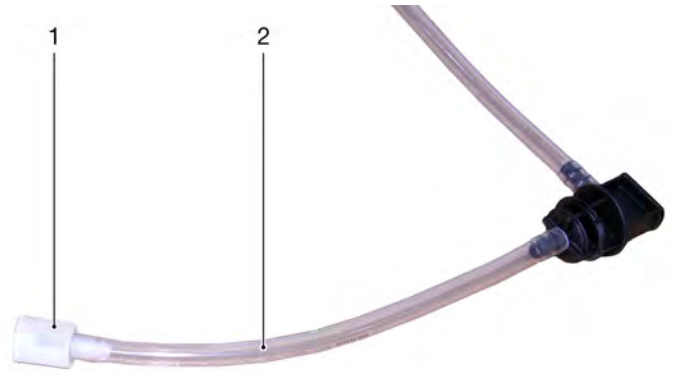

- 1 Filter
- 2 Suction hose for detergent

5.7.3 External suction

The suctioning of the detergent can also be performed outside the appliance.

For this, the suction hose of the detergent is routed to the outside via the recess in the chassis and then the hood is closed again.

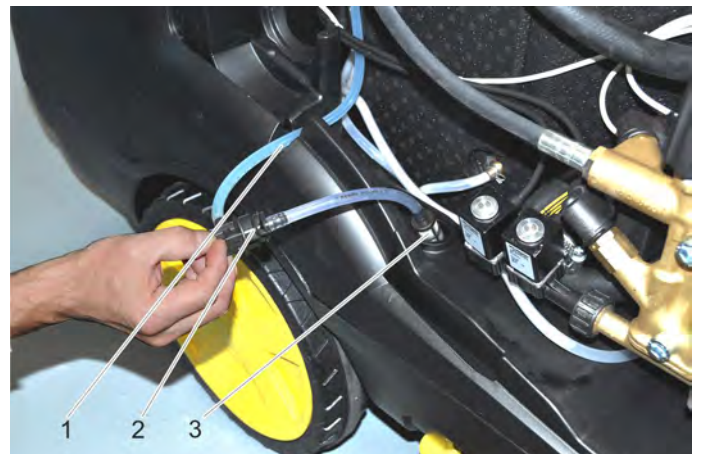

- 1 Recess
- 2 Suction hose for detergent 2
- 3 Filter



5.8 High-pressure pump

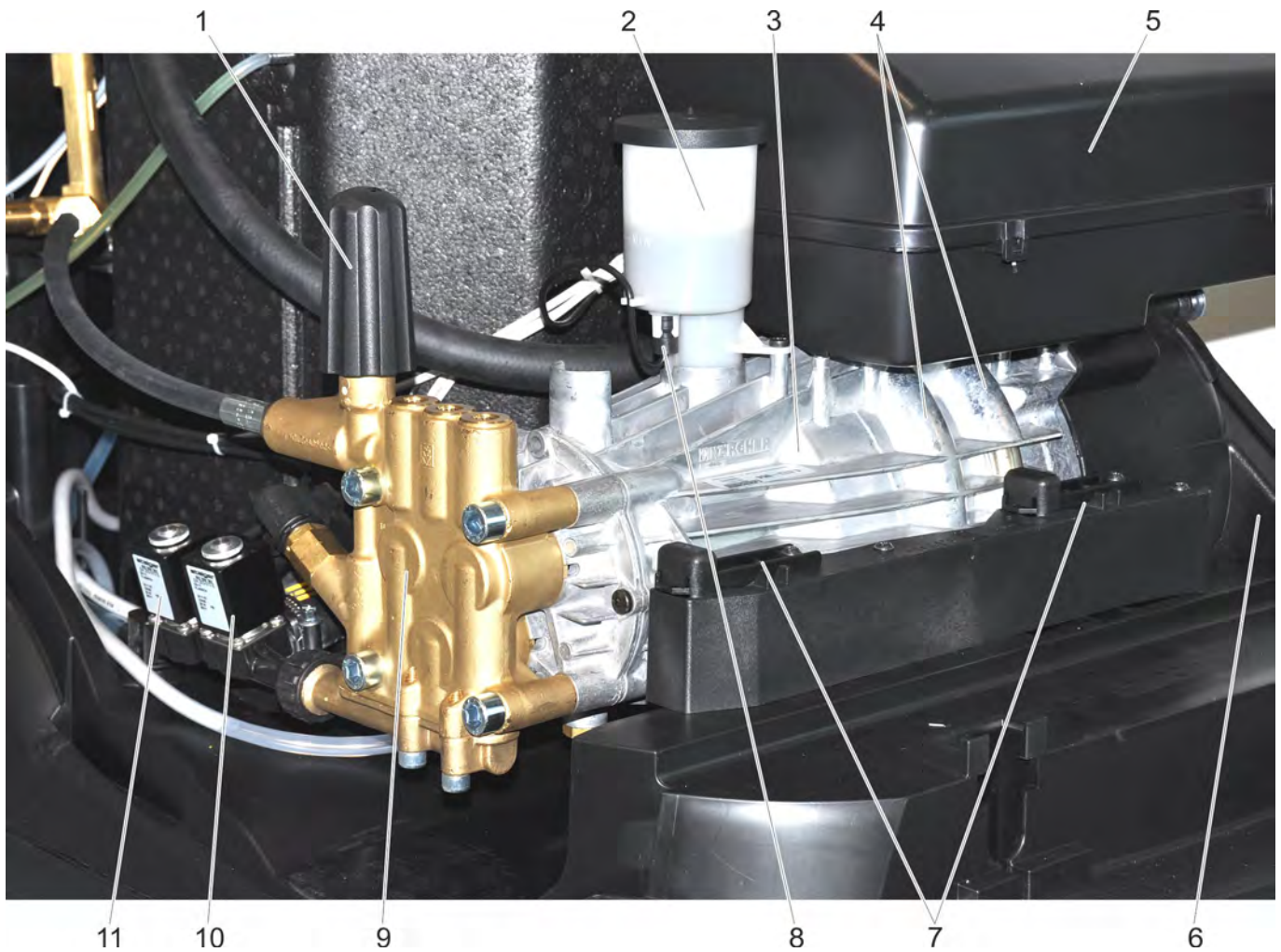

- 1 Pressure and volume regulation
- 2 Oil tank
- 3 Motor
- 4 Cooling coil of water cooling
- 5 Electric box, motor
- 6 Blower casing of engine air cooling
- 7 Motor intake
- 8 Oil level sensor
- 9 Pump head
- 10 Solenoid valve for cold water
- 11 Solenoid valve for warm water

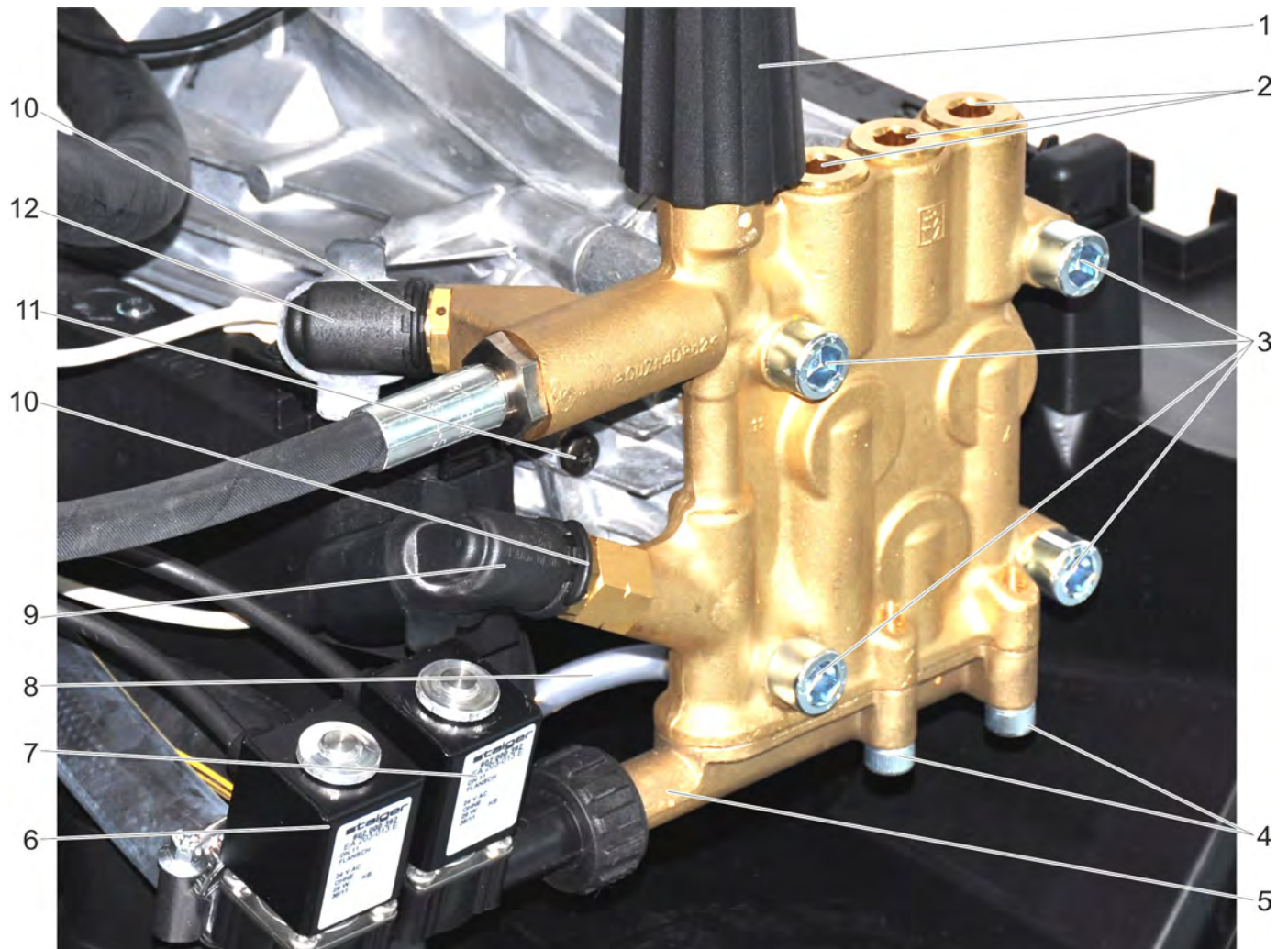

- 1 Pressure/ quantity regulation
- 2 Locking screw for pressure valve
- 3 Pump head screw
- 4 Suction jumper screw
- 5 Suction jumper
- 6 Solenoid valve for warm water
- 7 Solenoid valve for cold water
- 8 Suction hose for detergent
- 9 Pressure switch OFF
- 10 Fastener
- 11 Piston guide screw
- 12 Pressure switch ON



- 1 Oil level sensor
- 2 Oil tank
- 3 Oil container lid

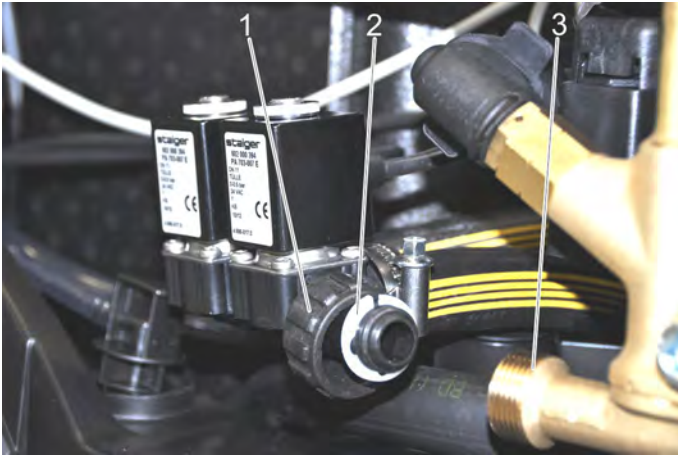

- 1 Union joint
- 2 Disc
- 3 Suction jumper



- 1 Union joint
- 2 Disc
- 3 Groove for disc

5.8.1 Sectional illustration

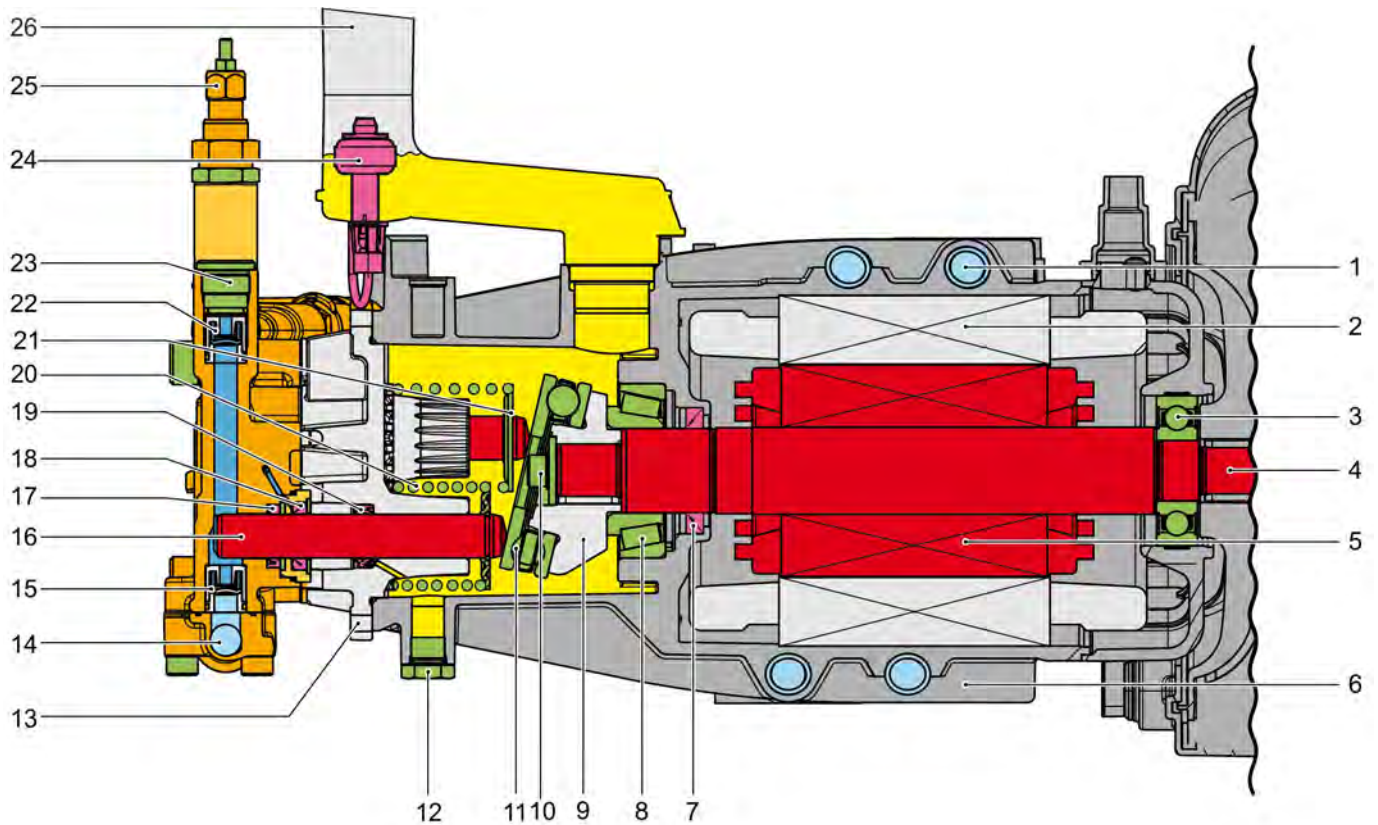

- 1 Cooling coil motor cooling
- 2 Stator
- 3 Motor bearing, rear (B bearing)
- 4 Motor shaft
- 5 Solenoid (rotor)
- 6 Motor casing
- 7 Shaft seal ring, motor shaft
- 8 Motor bearing, front (A bearing)
- 9 Swash plate
- 10 Fastening screw, swash plate
- 11 Axial ball bearing, swash plate
- 12 Oil drain screw
- 13 Piston guide
- 14 Suction side pump
- 15 Suction valve
- 16 Piston
- 17 High pressure seal
- 18 Low pressure seal
- 19 Oil seal
- 20 Piston spring
- 21 Holding plate of piston spring
- 22 Pressure valve
- 23 Valve screw
- 24 Level sensor for pump oil
- 25 Pressure and volume regulation
- 26 Oil tank

5.8.2 High pressure seal / low pressure seal

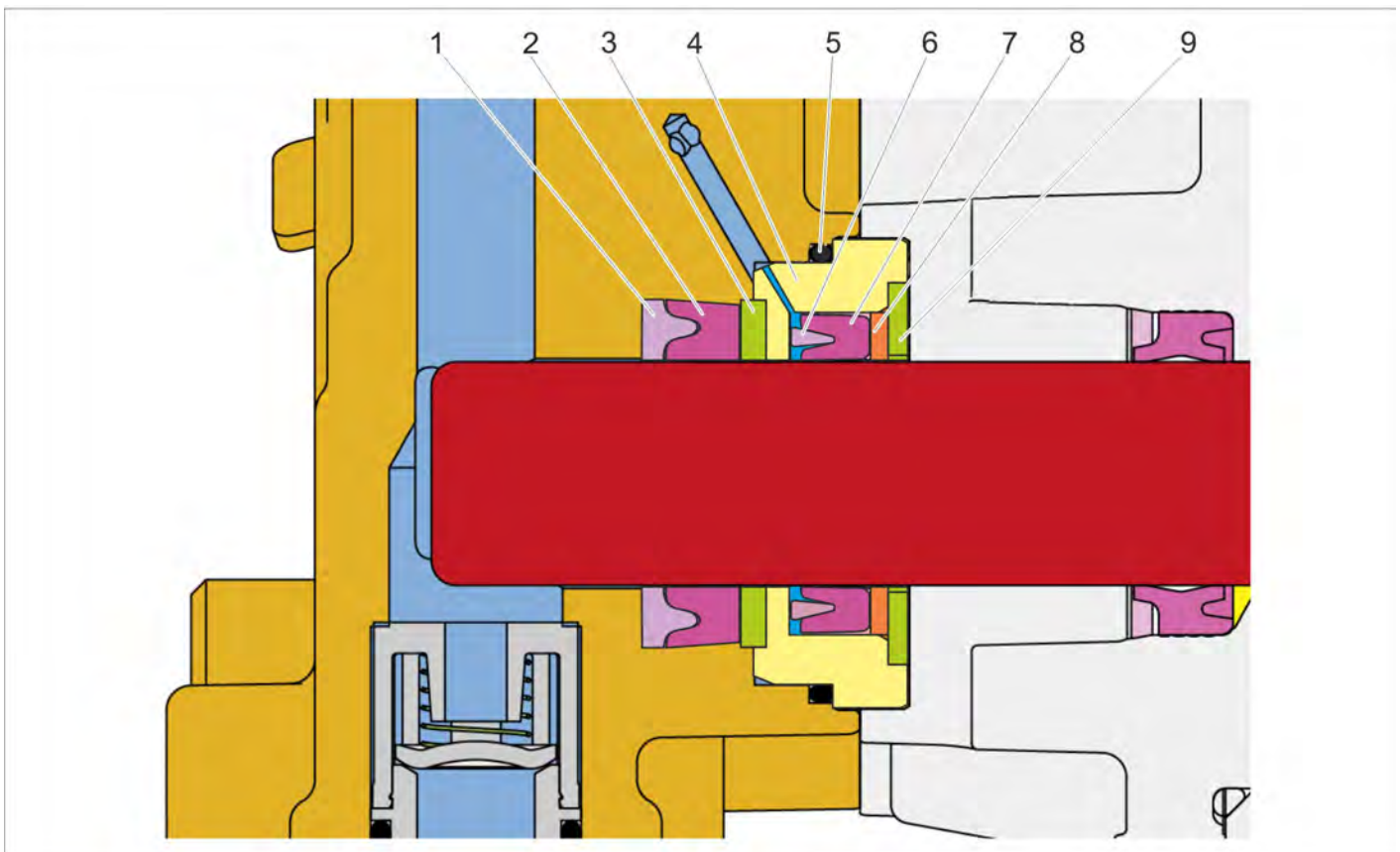

Seal package high pressure

- 1 Support ring
- 2 High pressure seal
- 3 Back ring

- 4 Bushing
- 5 O ring

Seal package low pressure

- 6 Support ring
- 7 Low pressure seal
- 8 Back ring

- 9 Brass support disc

Note:

- Pay attention to installation position of the seals!
- High pressure and low pressure seals consist of a 3-part seal package each.
- To increase the standstill time, the following seal packages are available (3-parts each):
 - Low pressure seal 2.885-236.0
 - High pressure seal 2.885-237.0
- 3 seal packages are required for each pump.

5.8.3 Electric box 12 kW

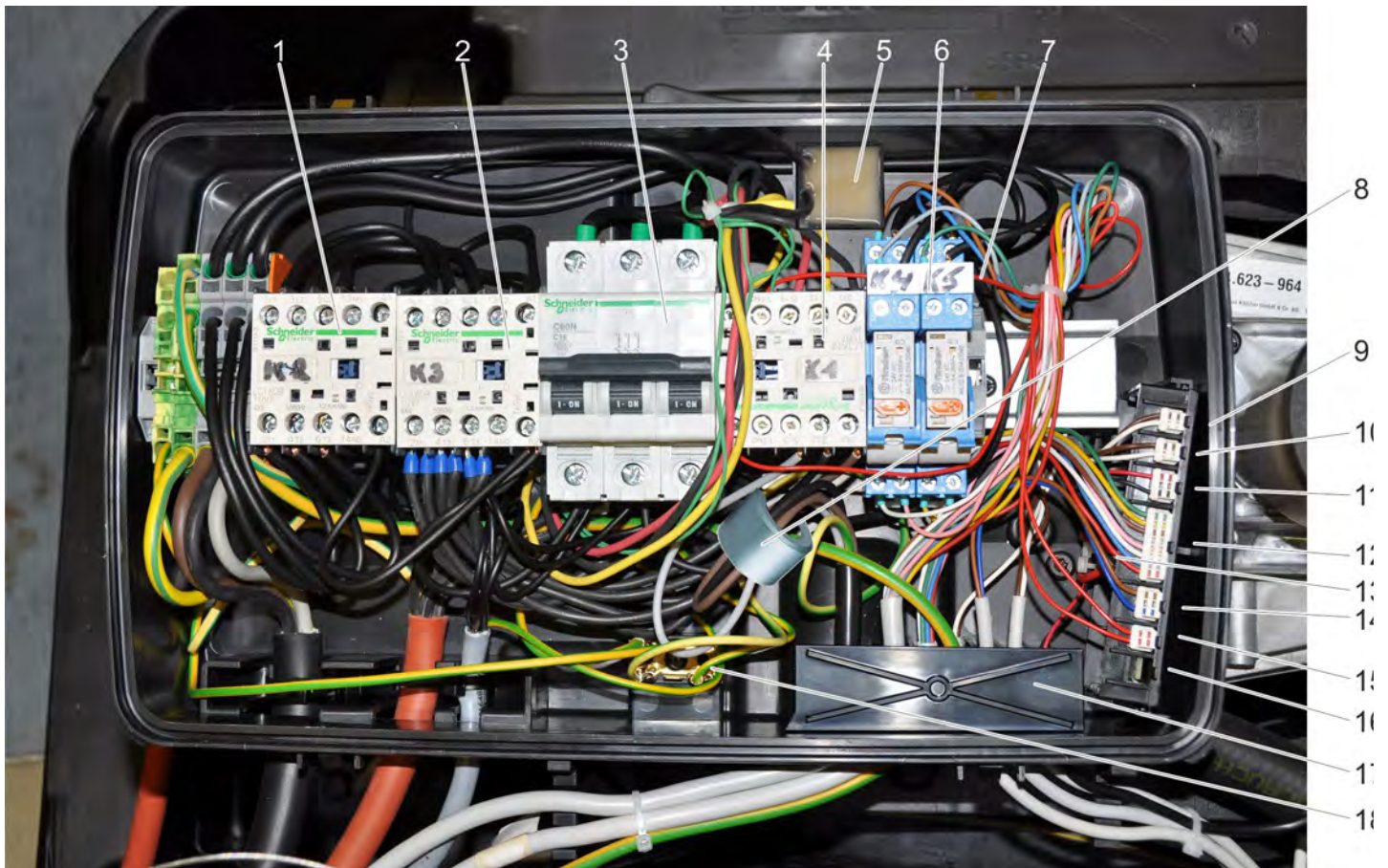

- 1 Contactor heater K2
- 2 Contactor heater K3
- 3 Circuit breaker, F1
- 4 Motor contactor, K1
- 5 Interference suppression capacitor for heater contactor
- 6 Relay lack of water fuse K4
- 7 Temperature limiter relay K5
- 8 Ferrite core in the motor supply line
- 9 Connection pressure switch ON
- 10 Connection pressure switch OFF
- 11 Oil level sensor connection
- 12 Control electronics connection, operating panel
- 13 Connection of coiling protection contact
- 14 Connection of reciprocation pump for system care
- 15 Connection motor protection
- 16 Connection is not used
- 17 Cable comb
- 18 Connection, protective conductor

5.8.4 Electric box 24 kW

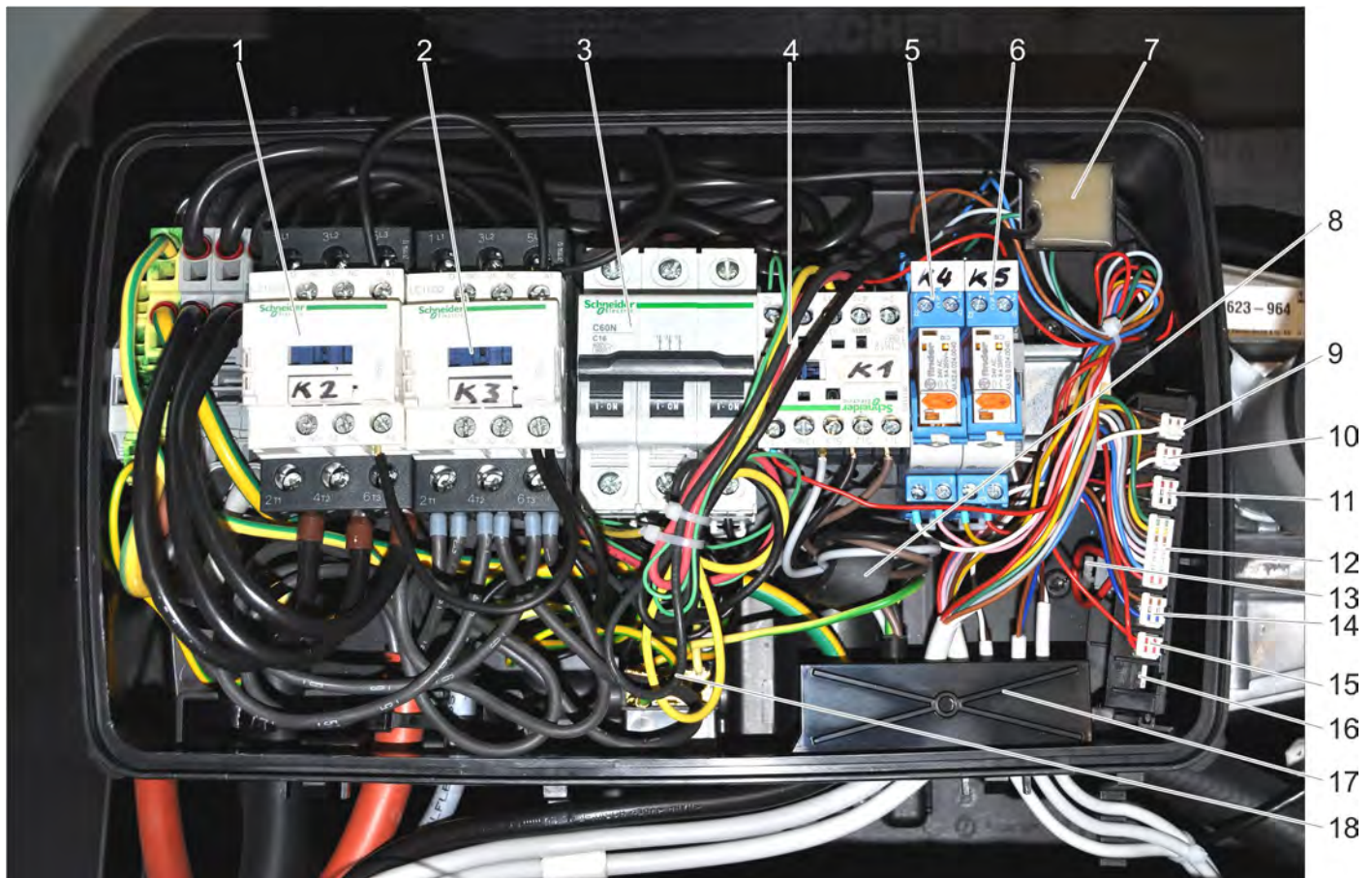

- 1 Contactor heater K2
- 2 Contactor heater K3
- 3 Circuit breaker, F1
- 4 Motor contactor, K1
- 5 Relay lack of water fuse K4
- 6 Temperature limiter relay K5
- 7 Interference suppression capacitor for heater contactor
- 8 Ferrite core in the motor supply line
- 9 Connection pressure switch ON
- 10 Connection pressure switch OFF
- 11 Oil level sensor connection
- 12 Control electronics connection, operating panel
- 13 Connection of coiling protection contact
- 14 Connection of reciprocation pump for system care
- 15 Connection motor protection
- 16 Connection is not used
- 17 Cable comb
- 18 Connection, protective conductor

5.8.5 Electric box 36 kW

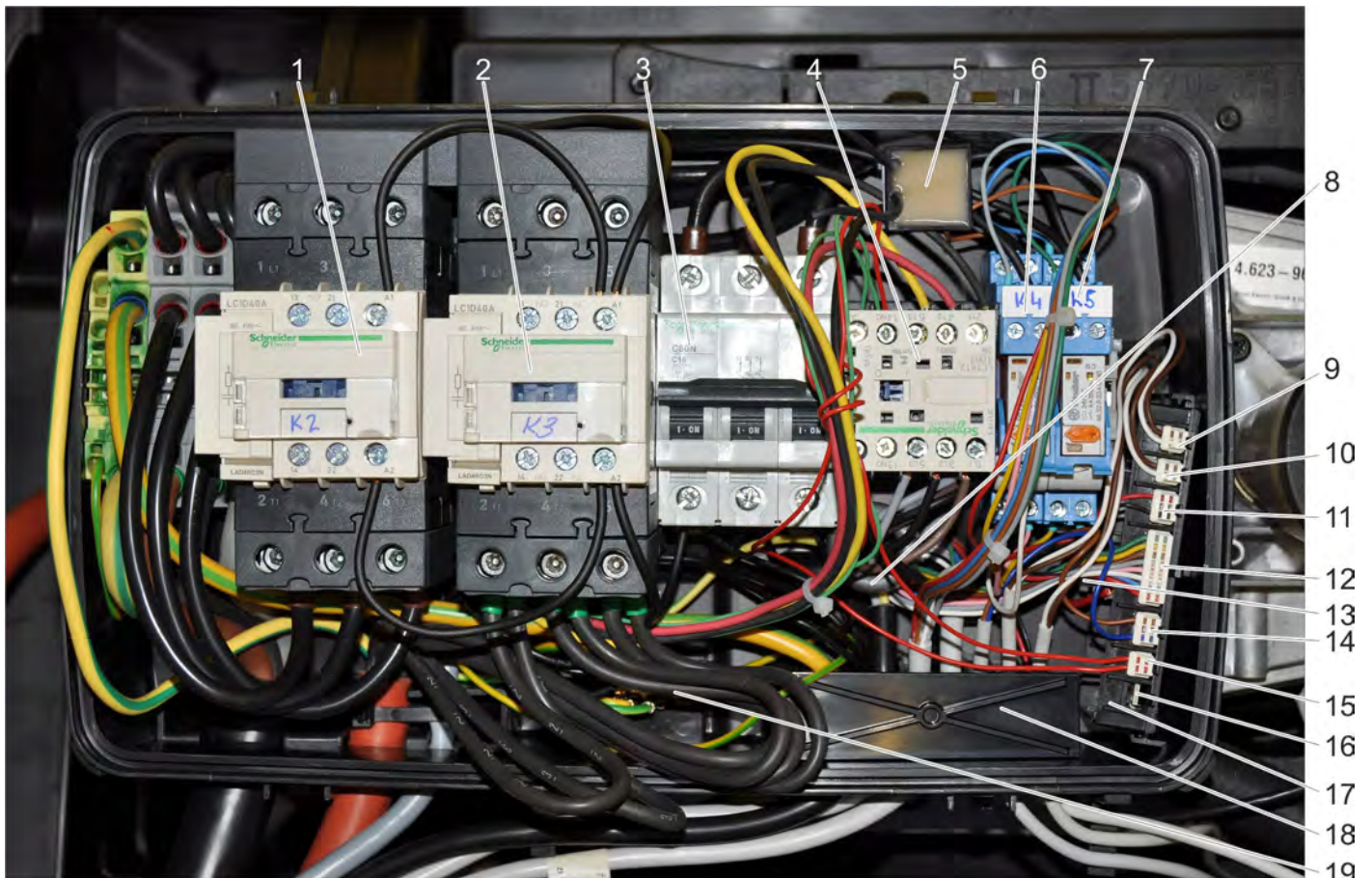

- 1 Contactor heater K2
- 2 Contactor heater K3
- 3 Circuit breaker, F1
- 4 Motor contactor, K1
- 5 Interference suppression capacitor for heater contactor
- 6 Relay lack of water fuse K4
- 7 Temperature limiter relay K5
- 8 Ferrite core in the motor supply line
- 9 Connection pressure switch ON
- 10 Connection pressure switch OFF
- 11 Oil level sensor connection
- 12 Control electronics connection, operating panel
- 13 Connection of coiling protection contact
- 14 Connection of reciprocation pump for system care
- 15 Connection motor protection
- 16 Connection is not used
- 17 Distribution board
- 18 Cable comb
- 19 Connection, protective conductor

5.9 Hand spraygun

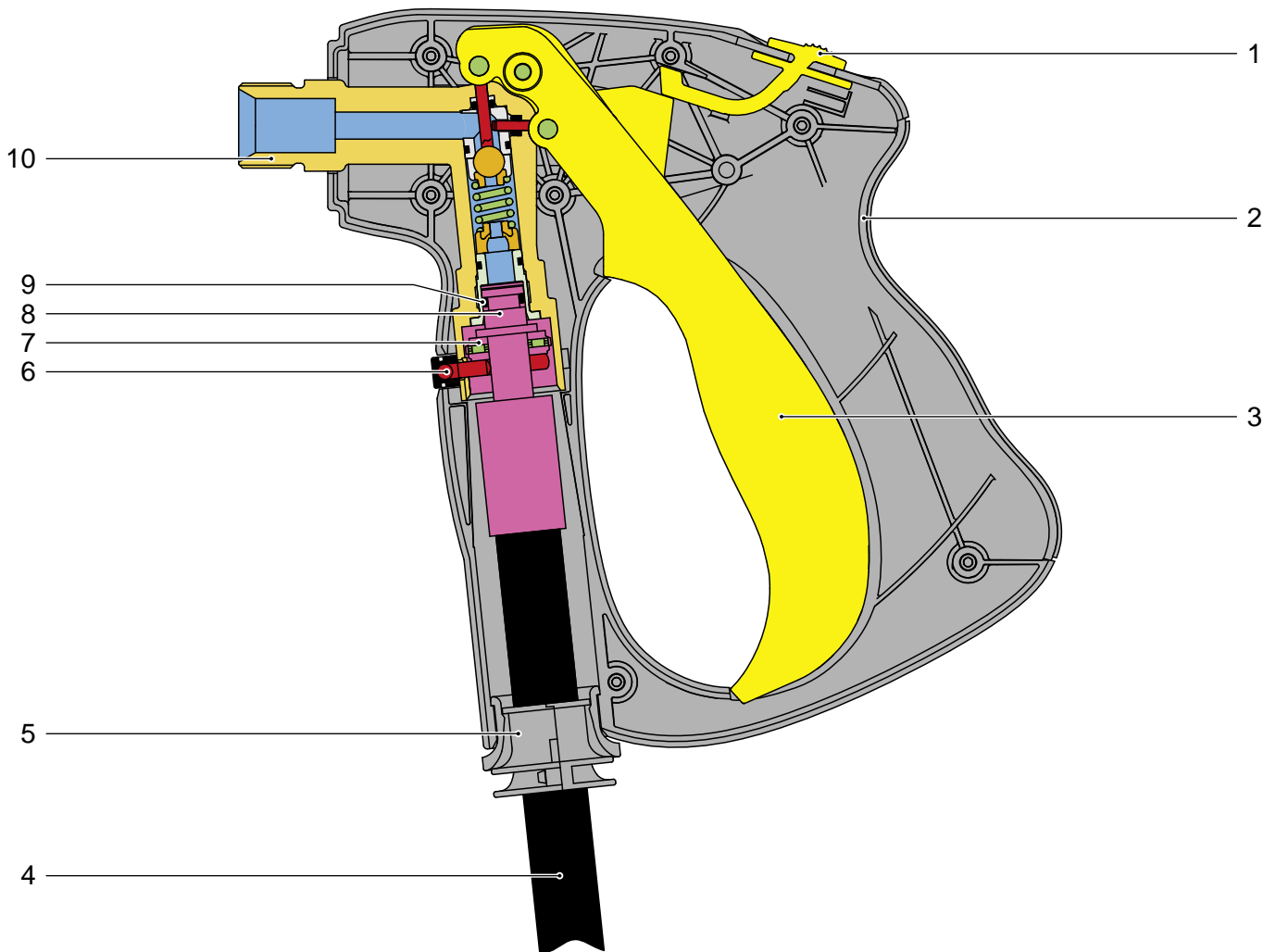

- 1 Safety catch
- 2 Handle bowl
- 3 Hand lever
- 4 High pressure hose
- 5 Hose guide

- 6 Safety clip
- 7 Needle bearing
- 8 Hose coupling
- 9 O ring
- 10 Node piece

Note

The node piece cannot be repaired and must be replaced as a complete unit.

The date of manufacture is imprinted on the node piece. It is composed of the month (letters A to L for January through December) and year (1-digit number 1 for 2011, 2 for 2012, etc.).

Example: H1 = August 2011

Function

When the manual lever is actuated, the valve in the node piece opens and the water can flow from the hose through the gun into the spray lance.

5.10 Rotating regulator

The pressure and volume regulation is performed via a rotating regulator between the gun and the spray lance.

There are two ceramic discs within the high pressure channel.

One ceramic disc is rigidly connected to the gun connection. The other ceramic disc is connected to the rotating regulator and therefore adjustable.

Offset holes in the ceramic discs can adjust the flow volume and the pressure when rotating the discs.

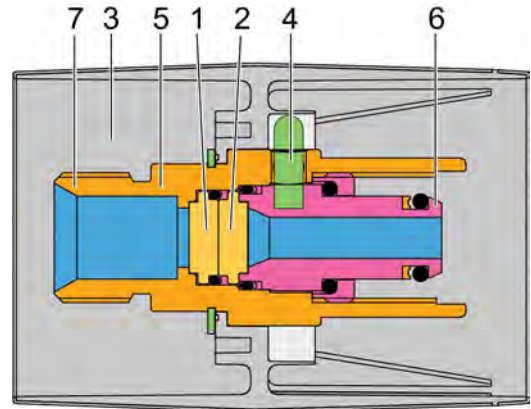

- 1 Ceramic disc on spray pipe side
- 2 Ceramic disc on gun side
- 3 Handle
- 4 Connecting pin
- 5 Casing
- 6 Gun connection
- 7 Spray pipe connection



- 1 Ceramic disc on spray pipe side
- 2 Ceramic disc on gun side

This illustration shows the two overlapping ceramic discs and the water flow (blue) with different opening angles (from 0° to 90°).

With the minimal setting, the water flows through a small hose in the middle of the ceramic discs.

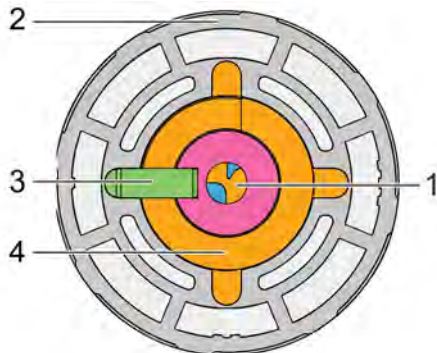

Diameter

- 1 Ceramic disc on gun side
- 2 Handle
- 3 Connecting pin
- 4 Casing

5.11 Functional diagram

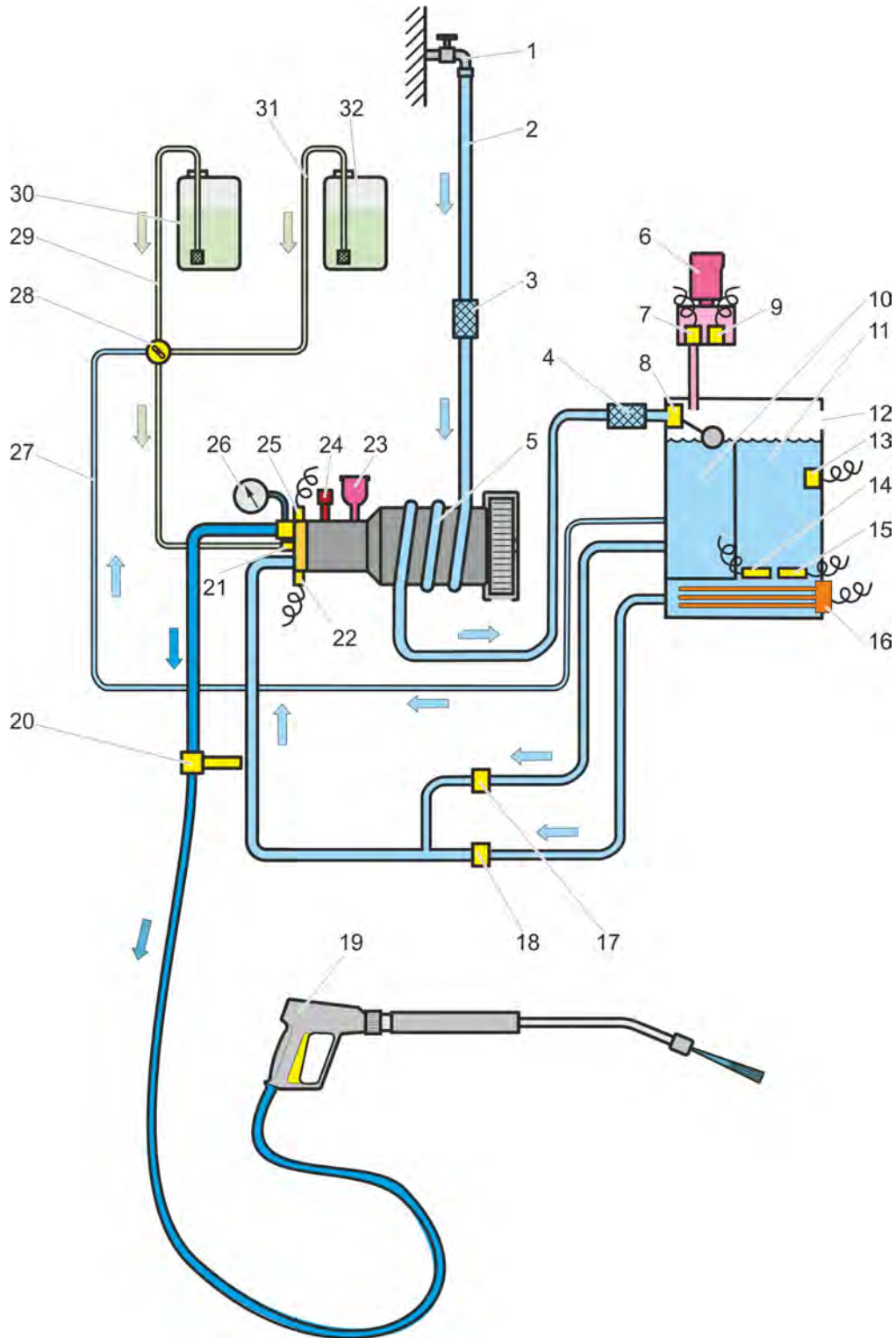

- | | |
|----------------------------------|--------------------------------------|
| 1 Water connection | 12 Overflow |
| 2 Water supply hose | 13 Water shortage safeguard |
| 3 Rough dirt filter | 14 Temperature sensor |
| 4 Water fine filter | 15 Temperature controller |
| 5 Motor casing with cooling coil | 16 Heating element |
| 6 System care bottle | 17 Solenoid valve for cold water |
| 7 Reciprocating pump | 18 Solenoid valve for warm water |
| 8 Swimmer valve | 19 Hand blowing gun |
| 9 Level sensor for system care | 20 Safety valve |
| 10 Cold water tank | 21 Detergent suction hose connection |
| 11 Warm water tank | 22 Pressure switch "OFF" |

- 23 Oil tank
- 24 Pressure and volume regulation
- 25 Pressure switch "ON"
- 26 Manometer
- 27 Rinse hose of the detergent dosing valve
- 28 Dosage valve for detergent
- 29 Detergent suction hose with filter
- 30 Detergent Tank
- 31 Detergent suction hose with filter
- 32 Detergent Tank

5.12 Pressure and volume regulation

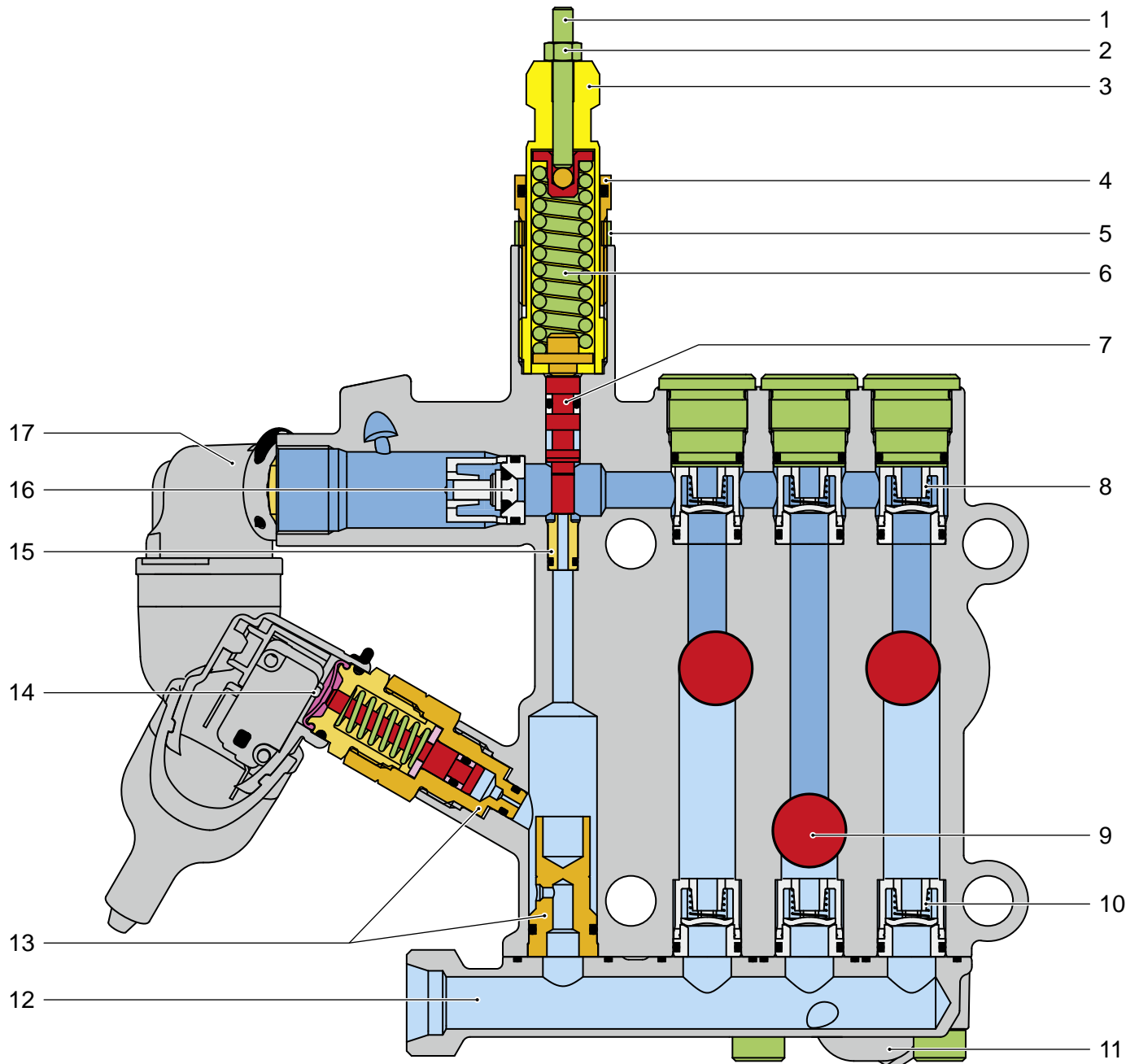

- 1 Threaded pin, max. pressure setting
- 2 Locknut threaded pin
- 3 Semiload spindle
- 4 Half-load stop sleeve
- 5 Locknut of semiload stop sleeve
- 6 Pressure spring
- 7 Overflow piston
- 8 High pressure valve (3x)
- 9 Pump piston (3x)
- 10 Suction valve (3x)
- 11 Detergent infeed with backflow valve
- 12 Suction jumper with water connection
- 13 Sleeve with throttle bore
- 14 Pressure switch "OFF"
- 15 Valve seat

- 16 Pressure holding valve
- 17 Pressure switch "ON"

5.12.1 Pressure and quantity regulation at the pump

The pressure and volume regulation via the handle on the high pressure pump is used to relieve the motor with mostly partial load operation.

Turning the spindle anticlockwise lowers the pre-tension of the pressure spring.

This will lift the overflow piston with a lower pressure from the valve seat and part of the flowing volume runs to the suction chamber via the sleeve with the throttle bore.

The pump runs at reduced pressure.

Depending on the spindle setting, the pressure and the water volume change.

5.12.2 Rotating regulator on the hand spray gun

The pressure and volume regulation via the rotary regulator on the gun should only be used during occasional partial load operation.

When the pressure is reduced via the rotary regulator, the manual pressure and volume regulation on the pump must always be closed all the way (direction "+" on the handle); otherwise, the device will shut off prematurely.

If the rotary regulator is partially closed, the pressure in the system will increase.

This will lift the piston off the valve seat so that a part of the flowing volume flows back to the suction chamber via the return.

The pump continues to run at high pressure.

Depending on the setting of the rotary regulator on the gun, the pressure and the water volume change.

5.12.3 Gun closed

If the gun is closed completely, the piston will open all the way and the entire flow volume of the pump flows to the suction chamber via the throttle bore.

The dynamic pressure building up through the throttle bore of the sleeve in the return actuates the pressure switch which will in turn shut off the appliance.

5.13 Functional description of pressure switch

5.13.1 Appliance is switched off

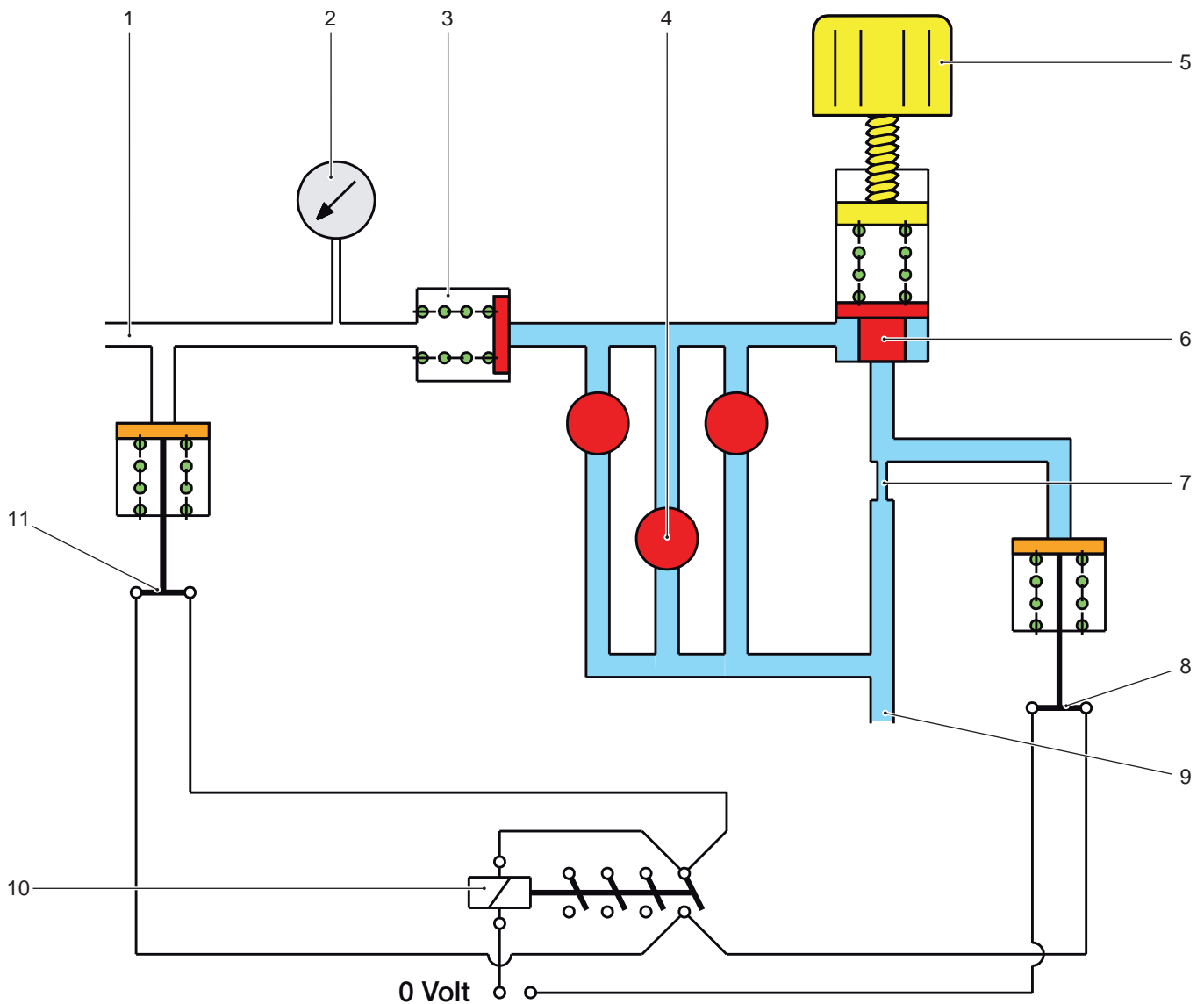

- 1 High pressure outlet (without pressure)
- 2 Manometer (without pressure)
- 3 Pressure retaining valve (closed)
- 4 Pump stands still
- 5 Rotary knob
- 6 Overflow valve (closed)
- 7 Throttle bore
- 8 Pressure switch "OFF" (closed)
- 9 Water inlet
- 10 Motor contactors (K1) (open)
- 11 Pressure switch "ON" (closed)

When the appliance is switched off and the gun is open, the pressure is taken from the system and it is without voltage.

Both pressure switches as well as the overflow valve and the pressure retaining valve closed.

The motor contactors are open.

Note

The shown functions of the pressure switches and motor contactor are for understanding purposes only. In reality, the information from the two pressure switches is transferred directly to the control electronics, which in turn controls the motor contactor.

5.13.2 The appliance is switched on and the gun is open

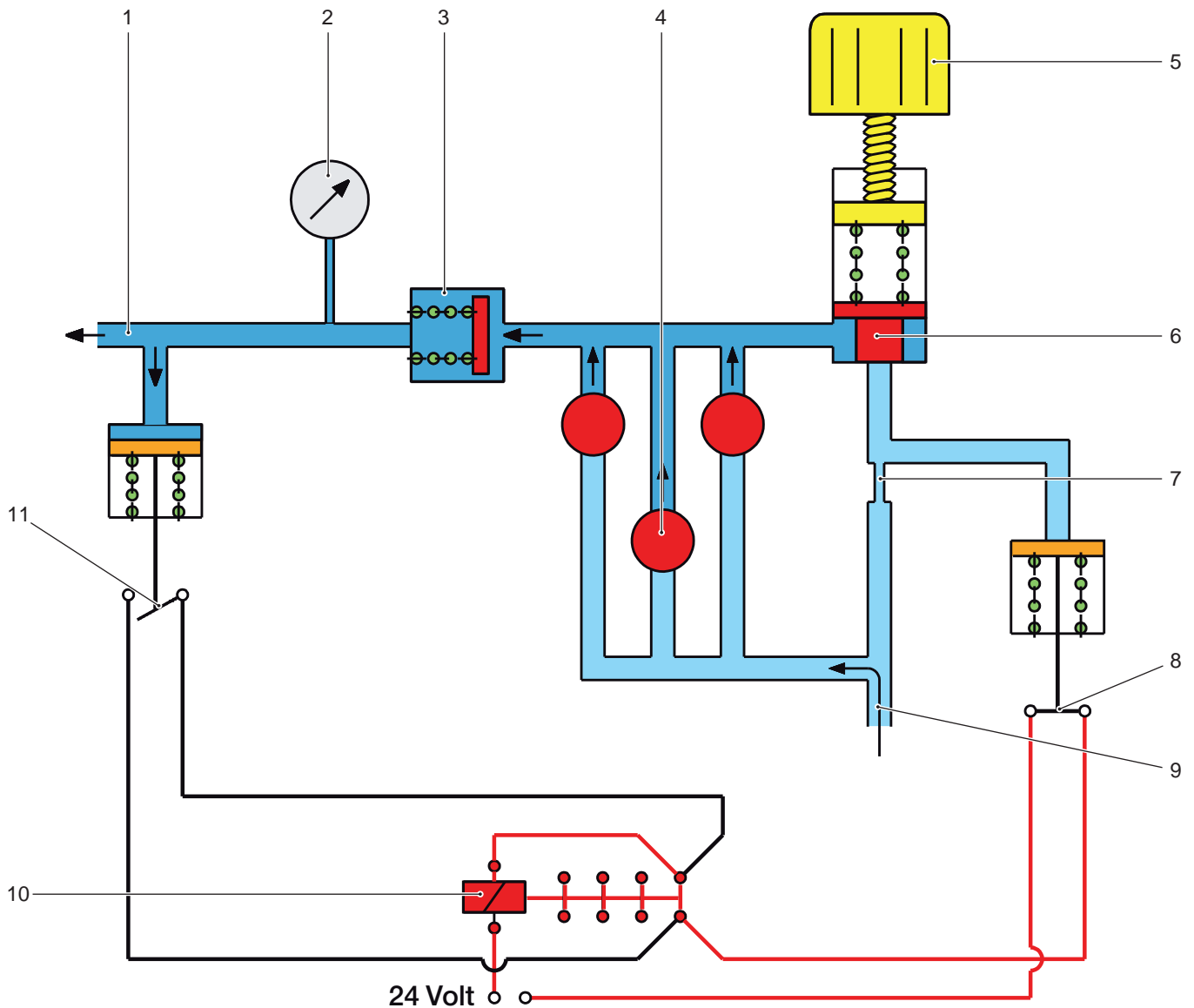

- 1 High pressure outlet, working pressure
- 2 Manometer, working pressure
- 3 Pressure retaining valve (open)
- 4 Pump is running
- 5 Rotary knob
- 6 Overflow valve (closed)
- 7 Throttle bore
- 8 Pressure switch "OFF" (closed)
- 9 Water inlet
- 10 Motor contactors (K1) (closed)
- 11 Pressure switch "ON" (open)

After switching on the appliance and with the gun open, the contactor will be actuated and closes the contacts. This will start the motor and the pump will build up the working pressure. The pressure retaining valve and the pressure switch open, the overflow valve and the pressure switch remain closed. Due to the closed pressure switch, the motor contactors also remain closed.

Note

The shown functions of the pressure switches and motor contactor are for understanding purposes only. In reality, the information from the two pressure switches is transferred directly to the control electronics, which in turn controls the motor contactor.

5.13.3 Gun is closed

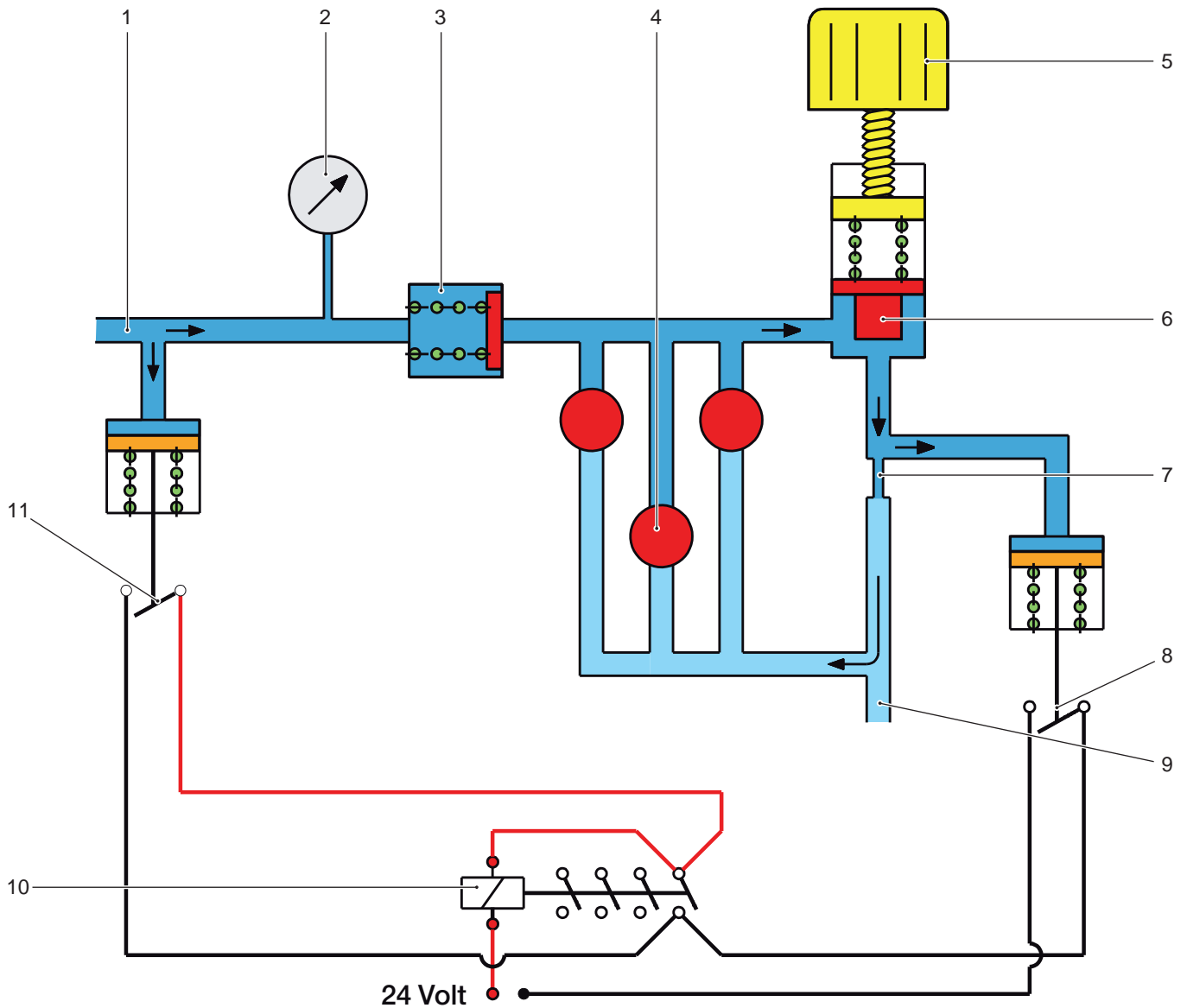

- 1 High pressure outlet, shut-off pressure
- 2 Manometer, shut-off pressure
- 3 Pressure retaining valve (closed)
- 4 Pump stands still
- 5 Rotary knob
- 6 Overflow valve
- 7 Throttle bore
- 8 Pressure switch "OFF" (open)
- 9 Water inlet
- 10 Motor contactors (K1) (open)
- 11 Pressure switch "ON" (open)

Note

The shown functions of the pressure switches and motor contactor are for understanding purposes only. In reality, the information from the two pressure switches is transferred directly to the control electronics, which in turn controls the motor contactor.

This will open the overflow valve and the entire flow volume streams into the suction chamber of the pump through the throttle bore. As soon as the overflow valve opens, the pressure retaining valve closes and the shut-off pressure is locked between the gun and the pressure retaining valve. Due to the locked in shut-off pressure, the pressure switch remains open. There will be a pressure backup in front of the throttle bore, which opens the pressure switch at about 10 bar and thus interrupts the control circuit. The motor contactors open and the motor is shut off. As soon as the motor stops, the overflow valve will close and so will the pressure switch. However, the motor contactors will remain open as the control circuit is still interrupted by the open pressure switches.

There will be brief overpressure in the system when the gun is closed.

5.13.4 The gun is reopened when the appliance is switched on

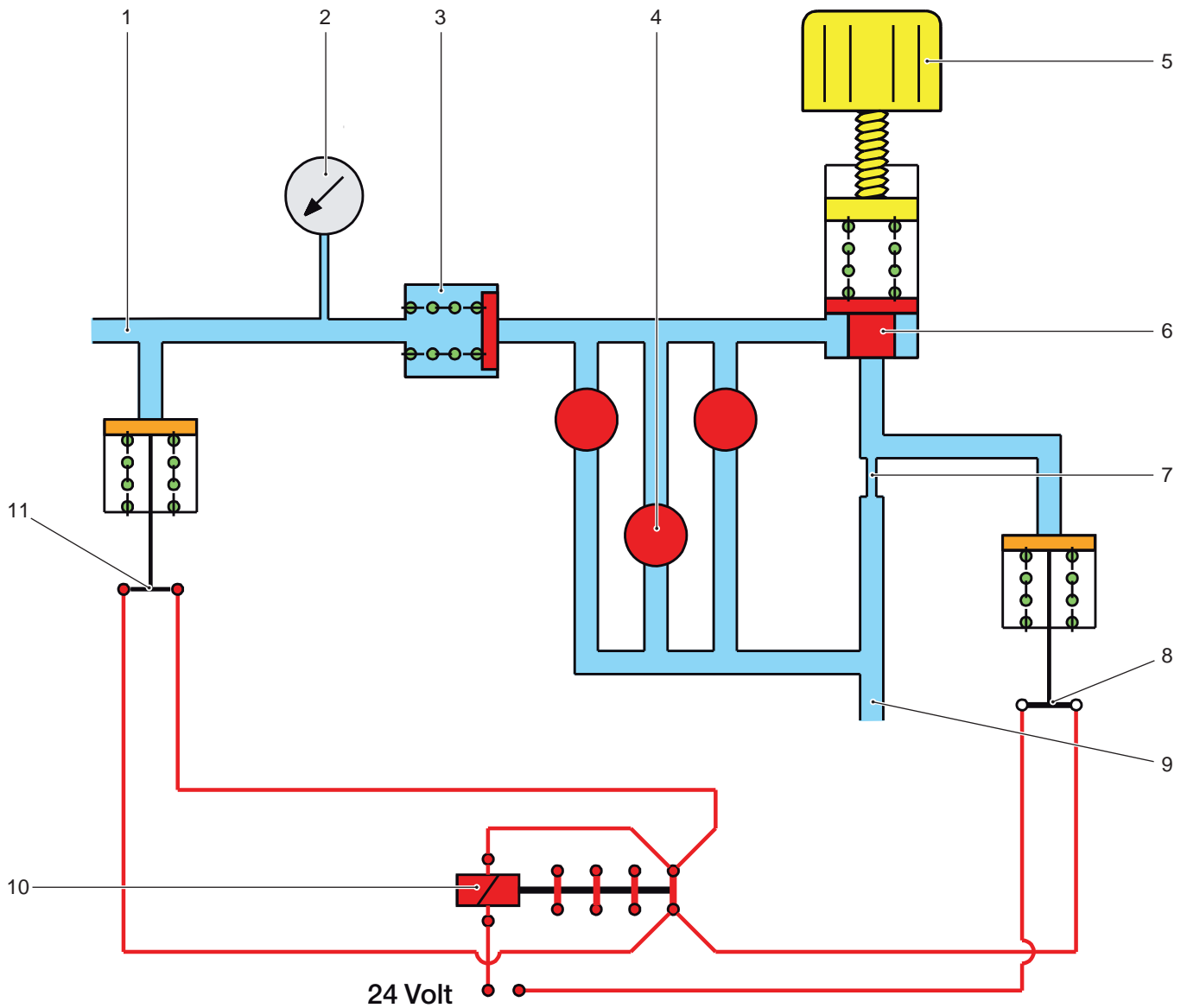

- 1 High pressure outlet (without pressure)
- 2 Manometer (without pressure)
- 3 Pressure retaining valve (closed)
- 4 Pump is running
- 5 Rotary knob
- 6 Overflow valve (closed)
- 7 Throttle bore
- 8 Pressure switch "OFF" (closed)
- 9 Water inlet
- 10 Motor contactors (K1) (closed)
- 11 Pressure switch "ON" (closed)

As soon as the gun is opened, the pressure that is locked in between the pressure retaining valve and the gun escapes. The pressure switch closes, which in turn will close the control circuit. The motor contactor is actuated, closes the contacts, the motor starts up and the pump rebuilds the working pressure.

Note

The shown functions of the pressure switches and motor contactor are for understanding purposes only. In reality, the information from the two pressure switches is transferred directly to the control electronics, which in turn controls the motor contactor.

5.14 Functional description of the control

5.14.1 Hot water/cold water solenoid valves

Pump start	First, the respective solenoid valve for cold or warm water will open and 0.3 s later, the high pressure pump starts up.
Switching from warm to cold water (or vice-versa) with the high pressure pump running	Both solenoid valves are opened for 0.5 s simultaneously.
Pump stop	The currently open solenoid valve (warm or cold water) closes 5 seconds after the high pressure pumps is shut off.

5.14.2 Water shortage safeguard

If the water level in the boiler sinks, the lack of water fuse is triggered. The following processes are triggered by the control if there is a lack of water:

Immediately	The heating element in the boiler is switched off. Indicator lamp for lack of water lights up.
After 120 seconds	The high pressure pump is stopped. The indicator lamp for the pump (oil tin) blinks three times.

5.14.3 Heating

The control electronics limit the water temperature in the "Eco" operation setting to 60 °C and to approx. 80 °C in warm water operation mode.

Switch-on conditions for the heater:

- Thermostat in position "Eco" or warm water operation.
- Lack of water fuse has detected a sufficient water level for 5 consecutive seconds.
- The water temperature at the temperature sensor is lower than the selected temperature at the thermostat.

The heater is only switched on if all three conditions are fulfilled.

Switch-off conditions for the heater:

Immediately	Water temperature of 90 °C or more. Indicator lamp for boiler fault blinks once.
Immediately	In case of water shortage. The indicator lamp for the pump (oil tin) blinks three times.
10 seconds after the temperature selected on the thermostat is reached	avoids frequent switching of the contactors during normal operation.
After 5 hours	If no RFID tag is detected or once the 5-hour trailing time has elapsed (indicator lamp system care blinks once).

5.14.4 Reciprocating pump (system care)

- Dosing time 0.2 seconds. (The reciprocating pump is energised with voltage for 0.2 seconds and executes a stroke of the reciprocating piston during this time).
- The reciprocating pump is only activated if the motor contactor is operated.
- If a dosing is in progress, the motor contactor will switch off with a delay of 0.4 seconds after the reciprocating pump so that the dosing can be connected.
- If the system care tank is empty, the reciprocating pump is not activated (dry run protection).

6 Basic settings and service procedures

6.1 Service functions with display

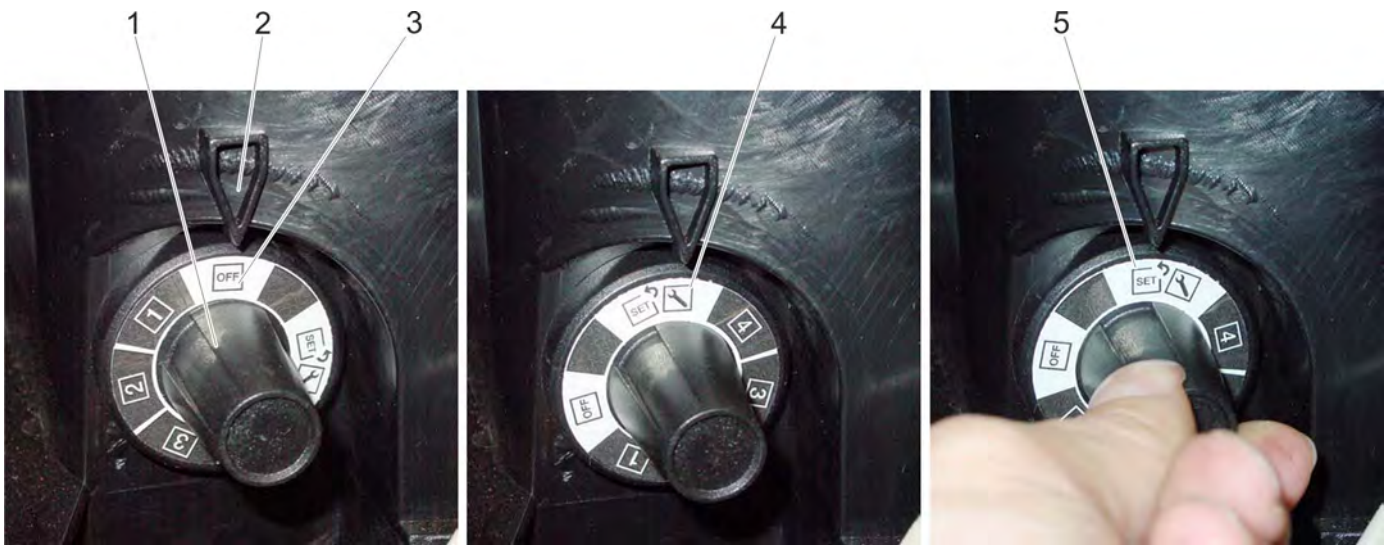

- 1 Service switch
 - 2 Arrow
 - 3 "OFF" position
 - 4 Service position
 - 5 SET position
- Key function (will not lock in)

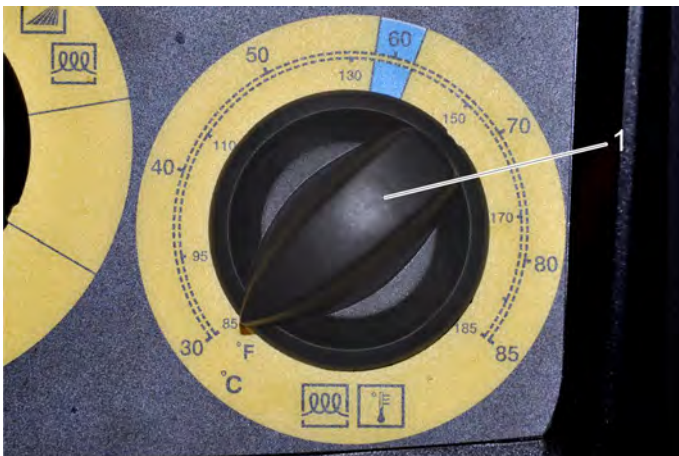

- 1 Temperature controller

6.1.1 Activating the service function

- Turn off the appliance.
- Note the service switch setting.
- Rotate the service switch into the service position
- Turn on the appliance.
- Set the thermostat to the desired function (see description of the different functions below).

The current setting of the selected function is displayed by the light pattern of the indicator lamps.

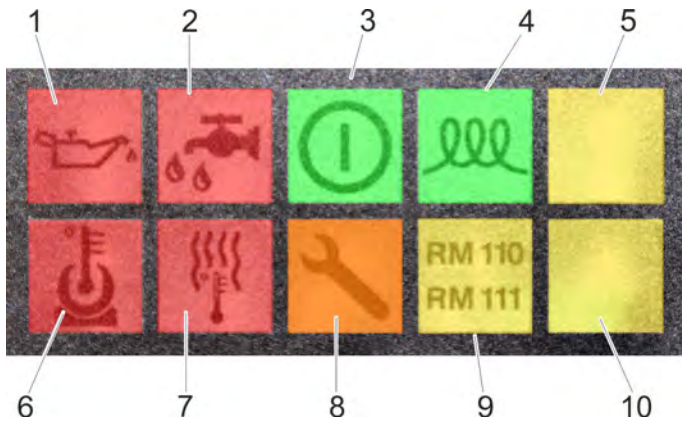

- 1 Indicator lamp 0, red
- 2 Indicator lamp 1, red
- 3 Indicator lamp 2, green
- 4 Indicator lamp 3, green
- 5 Indicator lamp 4, yellow
- 6 Indicator lamp 5, red
- 7 Indicator lamp 6, red
- 8 Indicator lamp 7, orange
- 9 Indicator lamp 8, yellow
- 10 Indicator lamp 9, yellow

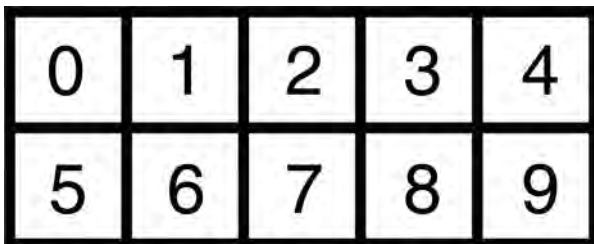

Mask to place on the operating panel
 Masks to be cut out can be found at the end of this service manual.

6.1.2 Changing the settings

- Rotate the service switch to "SET" and release it. The next setting of the service function will be displayed.
- Repeat this process until the desired setting is displayed.
- To save the setting, rotate the thermostat to the next service function.





6.1.3 Terminating the service function

- Turn off the appliance.
- Rotate the service switch back into its original position.
- Switch the machine back on again.



6.1.4 Overview of the service functions

	Function
30°C	Behaviour of device after 30 minutes of continuous operation.
33°C	Behaviour of device after 30 minutes of continuous standby operation.
35°C	Behaviour in case of leaks.
38°C	Testing the indicator lamps
38°C +SET	Device with/ without RFID
40°C	Water temperature display
43°C	Function control of device switch and thermostat
47°C	Service switch setting display.
50°C	Input test (oil level, pressure switch ON, auxiliary relay of heater, water level, pressure switch OFF, system care level)
53°C	Display of fault memory and software version (excess voltage, low voltage, excess current, phases asymmetrical, winding protective contact, lack of water, fault in auxiliary heater relay, lack of oil, leakage, temperature limiter, temperature sensor, RFID defective, software version)
53°C +SET	Delete the error memory.
57°C	System care consumption display.
60°C	Display of the gun switchings since the most recent gun service.
63°C	Number of gun services.
63°C +SET	Delete the gun service and fault memory.
67°C	Display of the gun switchings since device was first started up.
70°C	Operating hours since the last heater service.
73°C	Display of the heater service.
73°C +SET	Delete the heater service and fault memory.
77°C	Total heater operating hours.
80°C	Operating hours since the last pump service.
83°C	Display of the pump services.
83°C +SET	Delete the pump service and fault memory.
85°C	Total pump operating hours.



6.1.5 Set up the switching off process

	Function	adjustment	
		Display	Significance
30 °C	ON30MIN Behaviour of device after 30 minutes of continuous operation. The setting will be saved. Switching using SET.		The device switches off after 30 minutes of continuous operation Factory setting
			The device does not switch off after 30 minutes of continuous operation
33 °C	OFF30MIN Behaviour of device after 30 minutes of continuous standby operation. The setting will be saved. Switching using SET.		The device switches off after 30 minutes of standby operation The heater in the boiler also shuts off.
			The device does not switch off after 30 minutes of standby operation (factory setting).



6.1.6 Set up the leakage behaviour

	Function	adjustment	
		Display	Significance
35 °C	LECKAGEONOFF Switching using SET.		The device switches off after 10 short startups of the pump (factory setting).
			The device does not switch off after 10 short startups of the pump.















6.1.7 Check the indicator lamps

	Function	adjustment	
		Display	Significance
38 °C	LEDTEST	 	The two light patterns are shown alternately to control the function of the LEDs in the indicator lamps.











6.1.8 RFID query











	Function	adjustment	
		Display	Significance
38 °C + „SET“	RFIDONOFF Information to the control electronics whether the device is equipped with supplemental dosing via RFID.		Device with RFID
			Device without RFID



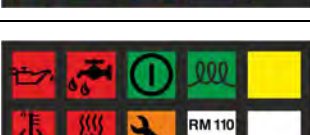

6.1.9 Check the temperature sensor

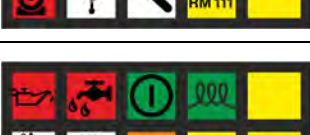
	Function	adjustment		
		Display	Significance	
40 °C NTCTEST Display of the water temperature measured by the temperature sensor. The value is shown digit by digit via the indicator lamps. The display is repeated after a pause. Example: A temperature of 27°C is measured. The indicator lamps light up in the following sequence:   PAUSE  			Digit value "0"	
			Digit value "1"	
			Digit value "2"	
			Digit value "3"	
			Digit value "4"	
			Digit value "5"	
			Digit value "6"	
			Digit value "7"	
			Digit value "8"	
			Digit value "9"	
	Note: At a temperature below 0°C, "0" is displayed.			









6.1.10 Check the thermostat and the device switch

	Function	adjustment	
		Display	Significance
43 °C ENCPROGTEST Use this function to test the device switch and the thermostat. In order to start the test: → Rotate the service switch to "SET" and release it. → Turn the thermostat to 30°C. By increasing the thermostat setting step by step, the control lamps are lighted in the pattern shown on the right side.		30 °C	
		33 °C	
		35 °C	
		38 °C	
		40 °C	
		43 °C	
		47 °C	
		50 °C	
		53 °C	
		57 °C	













	Function	adjustment	
		Display	Significance
43 °C			60 °C
			63 °C
			67 °C
			70 °C
			73 °C
			77 °C
			80 °C
			83 °C
			85 °C
			→ Adjust thermostat to 43 °C after the test.

	Function	adjustment	
		Display	Significance
43 °C	ENCPROGTEST → Rotate the service switch to "SET" and release it. The light pattern of the indicator lamps now shows the setting of the device switch.		Operating with cold water
			Eco! efficiency setting
			Operating with hot water















6.1.11 Check the service switch



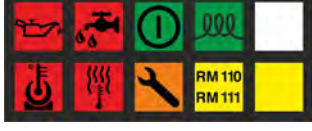

	Function	adjustment	
		Display	Significance
47 °C	ENCDGTTEST Service switch setting display.		Service switch setting "OFF"
			Service switch setting "1"
			Service switch setting "2"
			Service switch setting "3"
			Service switch setting "4"
			Service switch setting "Service"
			Service switch setting "SET"

6.1.12 Sensoren prüfen















	Function	adjustment	
		Display	Significance
50 °C INPUTTEST Use this function to display the status of the different sensors. Every indicator lamp displays the status of a certain sensor. Therefore, several indicator lamps can be illuminated at the same time. Example:  Significance <ul style="list-style-type: none"> Oil level sensor open (too little oil). ON pressure switch not actuated. Auxiliary relay of heating element contactor closed. Float contact of lack of water fuse closed (float up). OFF pressure switch not actuated. Reed switch "system care" closed (float up). 		Lack of oil fuse closed (float up).	
		ON pressure switch closed (switch actuated).	
		Not used.	
		Auxiliary relay of heating element closed.	
		Not used.	
		Float contact of lack of water fuse closed (float up).	
		OFF pressure switch closed (switch actuated).	
		Not used.	
		Reed switch "system care" closed (float up).	
		Not used.	

6.1.13 Error memory

	Function	adjustment	
		Display	Significance
<p>53 °C</p> <p>ERRORS Read the error memory. The display consists of 2 steps: 1 Display of the type of fault. 2 Display of the operating time that has elapsed since the fault occurred.</p> <p>→ Rotate the service switch to "SET" and release it. The next fault in the fault memory is displayed.</p> <p>Example:</p>  <p>PAUSE</p>   <p>Significance The pump has been operating for 14 hours since the fault "Winding protection contact open" occurred.</p>		High voltage range	
		Low voltage range	
		Overcurrent	
		Asymmetrical phases	
		Winding protection contact motor is open	
		Lack of water for more than 120 seconds	
		Auxiliary relay for heater is sticking	
		Lack of oil in the oil reservoir	
		Leakage (10 short startups lasting less than 2 seconds)	
		Temperature limiter in the boiler/heater was triggered	
	Temperature sensor short circuit or broken cable		

53 °C			Not used.																				
			Not used.																				
			RFID electronics defective.																				
			<p>End of the fault memory and display of the software version.</p> <p>Example:</p> <table border="1" data-bbox="997 728 1308 857"> <tr><td>0</td><td>1</td><td>2</td><td>3</td><td>4</td></tr> <tr><td>5</td><td>6</td><td>7</td><td>8</td><td>9</td></tr> </table> <table border="1" data-bbox="997 875 1308 1005"> <tr><td>0</td><td>1</td><td>2</td><td>3</td><td>4</td></tr> <tr><td>5</td><td>6</td><td>7</td><td>8</td><td>9</td></tr> </table> <p>Software version 1.8</p>	0	1	2	3	4	5	6	7	8	9	0	1	2	3	4	5	6	7	8	9
0	1	2	3	4																			
5	6	7	8	9																			
0	1	2	3	4																			
5	6	7	8	9																			
53 °C + „SET“	<p>Clearing the error memory</p> <ul style="list-style-type: none"> → Set the thermostat to 53°C. → Rotate the service switch into the "SET" position and hold it there. → Turn on the appliance. 																						

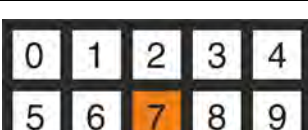
6.1.14 System care consumption

	Function	adjustment	
		Display	Significance
57 °C DGTDEZILITER System care consumption display. The number of used up bottles is displayed. The value is shown digit by digit via the indicator lamps. The display is repeated after a pause. Example: 12 bottles of system care were consumed. The indicator lamps light up in the following sequence:   PAUSE  			Digit value "0"
			Digit value "1"
			Digit value "2"
			Digit value "3"
			Digit value "4"
			Digit value "5"
			Digit value "6"
			Digit value "7"
			Digit value "8"
			Digit value "9"

6.1.15 Gun switches since the most recent gun service.

	Function	adjustment	
		Display	Significance
<p>60 °C</p> <p>SI_PISTOLE</p> <p>Display of the gun switchings since the most recent gun service.</p> <p>The value is shown digit by digit via the indicator lamps.</p> <p>The display is repeated after a pause.</p> <p>Example:</p> <p>The gun was actuated 430 times since the last gun service.</p> <p>The indicator lamps light up in the following sequence:</p> <div style="display: flex; flex-direction: column; align-items: center;"> <div style="display: flex; border: 1px solid black; padding: 2px;"> 0 1 2 3 4 </div> <div style="display: flex; border: 1px solid black; padding: 2px;"> 5 6 7 8 9 </div> <div style="margin: 5px 0;">PAUSE</div> <div style="display: flex; border: 1px solid black; padding: 2px;"> 0 1 2 3 4 </div> <div style="display: flex; border: 1px solid black; padding: 2px;"> 5 6 7 8 9 </div> <div style="margin: 5px 0;">PAUSE</div> <div style="display: flex; border: 1px solid black; padding: 2px;"> 0 1 2 3 4 </div> <div style="display: flex; border: 1px solid black; padding: 2px;"> 5 6 7 8 9 </div> <div style="margin: 5px 0;">PAUSE</div> <div style="display: flex; border: 1px solid black; padding: 2px;"> 0 1 2 3 4 </div> <div style="display: flex; border: 1px solid black; padding: 2px;"> 5 6 7 8 9 </div> </div>	<div style="display: flex; border: 1px solid black; padding: 2px;"> 0 1 2 3 4 </div> <div style="display: flex; border: 1px solid black; padding: 2px;"> 5 6 7 8 9 </div>	Digit value "0"	
		<div style="display: flex; border: 1px solid black; padding: 2px;"> 0 1 2 3 4 </div> <div style="display: flex; border: 1px solid black; padding: 2px;"> 5 6 7 8 9 </div>	Digit value "1"
		<div style="display: flex; border: 1px solid black; padding: 2px;"> 0 1 2 3 4 </div> <div style="display: flex; border: 1px solid black; padding: 2px;"> 5 6 7 8 9 </div>	Digit value "2"
		<div style="display: flex; border: 1px solid black; padding: 2px;"> 0 1 2 3 4 </div> <div style="display: flex; border: 1px solid black; padding: 2px;"> 5 6 7 8 9 </div>	Digit value "3"
		<div style="display: flex; border: 1px solid black; padding: 2px;"> 0 1 2 3 4 </div> <div style="display: flex; border: 1px solid black; padding: 2px;"> 5 6 7 8 9 </div>	Digit value "4"
		<div style="display: flex; border: 1px solid black; padding: 2px;"> 0 1 2 3 4 </div> <div style="display: flex; border: 1px solid black; padding: 2px;"> 5 6 7 8 9 </div>	Digit value "5"
		<div style="display: flex; border: 1px solid black; padding: 2px;"> 0 1 2 3 4 </div> <div style="display: flex; border: 1px solid black; padding: 2px;"> 5 6 7 8 9 </div>	Digit value "6"
		<div style="display: flex; border: 1px solid black; padding: 2px;"> 0 1 2 3 4 </div> <div style="display: flex; border: 1px solid black; padding: 2px;"> 5 6 7 8 9 </div>	Digit value "7"
		<div style="display: flex; border: 1px solid black; padding: 2px;"> 0 1 2 3 4 </div> <div style="display: flex; border: 1px solid black; padding: 2px;"> 5 6 7 8 9 </div>	Digit value "8"
		<div style="display: flex; border: 1px solid black; padding: 2px;"> 0 1 2 3 4 </div> <div style="display: flex; border: 1px solid black; padding: 2px;"> 5 6 7 8 9 </div>	Digit value "9"









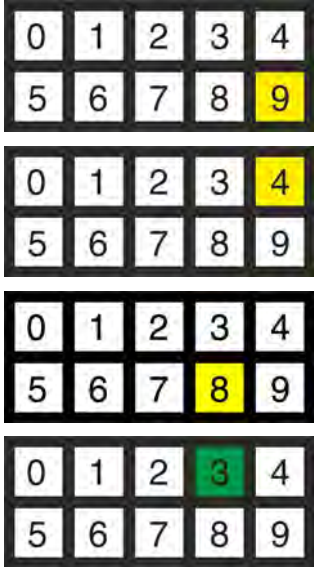

6.1.16 Gun services

	Function	adjustment	
		Display	Significance
63 °C	<p>SCTR_PISTOLE Number of gun services. The value is shown digit by digit via the indicator lamps. The display is repeated after a pause.</p> <p>Example: 11 gun services have been performed since the device was first used. The indicator lamps light up in the following sequence:</p> <div style="display: flex; flex-direction: column; align-items: center;"> <div style="display: flex; border: 1px solid black; padding: 2px;"> 0 1 2 3 4 </div> <div style="display: flex; border: 1px solid black; padding: 2px;"> 5 6 7 8 9 </div> <div style="margin: 5px 0;">PAUSE</div> <div style="display: flex; border: 1px solid black; padding: 2px;"> 0 1 2 3 4 </div> <div style="display: flex; border: 1px solid black; padding: 2px;"> 5 6 7 8 9 </div> </div>		





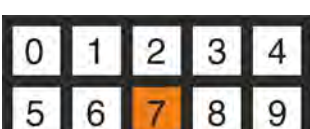









Reset the gun switches since the most recent gun service.
 → Turn off the appliance.
 → Turn the thermostat to 63 °C.
 → Rotate the service switch into the "SET" position and hold it there.

- Turn on the appliance.
- The gun switches since the last gun service are deleted.
 - The service counter gun (SCTR_PISTOLE) will be increased by 1.
 - The fault memory will be deleted.





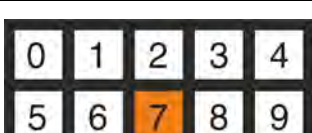







6.1.17 Gun switches since initial startup

	Function	adjustment	
		Display	Significance
67 °C TOTALPISTOLE Display of the gun switchings since device was first started up. The value is shown digit by digit via the indicator lamps. The display is repeated after a pause. Example: The gun was actuated 9483 times since the device was put into service. The indicator lamps light up in the following sequence:  PAUSE			Digit value "0"
			Digit value "1"
			Digit value "2"
			Digit value "3"
			Digit value "4"
			Digit value "5"
			Digit value "6"
			Digit value "7"
			Digit value "8"
			Digit value "9"

6.1.18 Operating hours of the heater since heater service

	Function	adjustment	
		Display	Significance
70 °C SI_BOILER Display of the operating time of the heater since the last heater service in hours. The value is shown digit by digit via the indicator lamps. The display is repeated after a pause. Example: The heater has been in operation for 47 hours since the last heater service. The indicator lamps light up in the following sequence:   PAUSE  			Digit value "0"
			Digit value "1"
			Digit value "2"
			Digit value "3"
			Digit value "4"
			Digit value "5"
			Digit value "6"
			Digit value "7"
			Digit value "8"
			Digit value "9"

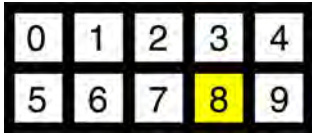
6.1.19 Heater service









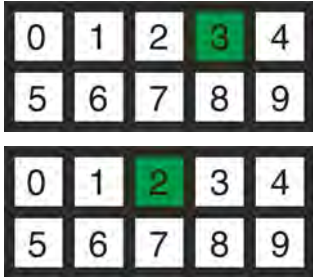
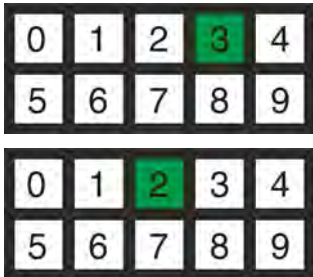

	Function	adjustment	
		Display	Significance
73 °C	SCTR_BOILER Display of the heater service. The value is shown digit by digit via the indicator lamps. The display is repeated after a pause. Example: 4 heater service tasks have been performed since the device was first used. The indicator lamps light up in the following sequence:  PAUSE 		Digit value "0"
			Digit value "1"
			Digit value "2"
			Digit value "3"
			Digit value "4"
			Digit value "5"
			Digit value "6"
			Digit value "7"
			Digit value "8"
			Digit value "9"

Reset the operating hours of the heater since heater service





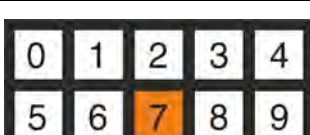









- Turn off the appliance.
- Turn the thermostat to 73°C.
- Rotate the service switch into the "SET" position and hold it there.

- Turn on the appliance.
 - The operating hours of the heater since heater service are deleted.
 - The service counter heater (SCTR_BOILER) will be increased by 1.
 - The fault memory will be deleted.





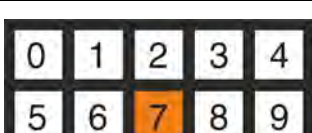





6.1.20 Operating hours of the heater since the startup of the device

	Function	adjustment	
		Display	Significance
77 °C TOTALBOILER Display of the operating time of the heater since the initial device startup in hours. The value is shown digit by digit via the indicator lamps. The display is repeated after a pause. Example: The heater has been in operation for 32 hours since the initial device startup. The indicator lamps light up in the following sequence:  PAUSE 			Digit value "0"
			Digit value "1"
			Digit value "2"
			Digit value "3"
			Digit value "4"
			Digit value "5"
			Digit value "6"
			Digit value "7"
			Digit value "8"
			Digit value "9"

6.1.21 Operating hours of the pump since pump service

	Function	adjustment	
		Display	Significance
80 °C SI_PUMPE Display of the operating time of the pump since the last pump service in hours. The value is shown digit by digit via the indicator lamps. The display is repeated after a pause. Example: The pump has been in operation for 31 hours since the last pump service. The indicator lamps light up in the following sequence:   PAUSE  			Digit value "0"
			Digit value "1"
			Digit value "2"
			Digit value "3"
			Digit value "4"
			Digit value "5"
			Digit value "6"
			Digit value "7"
			Digit value "8"
			Digit value "9"

6.1.22 Pump services

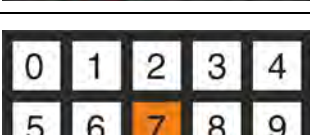
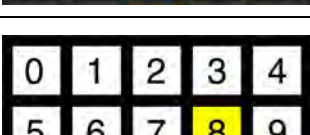
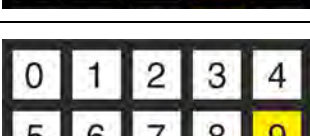













	Function	adjustment	
		Display	Significance
83 °C	SCTR_PUMPE Display of the pump services. The value is shown digit by digit via the indicator lamps. The display is repeated after a pause. Example: 7 pump services have been performed since the device was first used. The indicator lamps light up in the following sequence:  PAUSE 		Digit value "0"
			Digit value "1"
			Digit value "2"
			Digit value "3"
			Digit value "4"
			Digit value "5"
			Digit value "6"
			Digit value "7"
			Digit value "8"
			Digit value "9"

Reset the pump operating hours since the last pump service

- Turn off the appliance.
- Turn the thermostat to 83°C.
- Rotate the service switch into the "SET" position and hold it there.

- Turn on the appliance.
- The pump operating hours since the last pump service are deleted.
- The service counter pump (SCTR_PUMPE) will be increased by 1.
- The fault memory will be deleted.

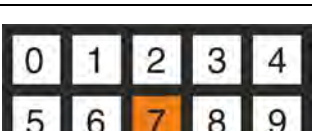











6.1.23 Operating hours of the pump since the start up of the device

	Function	adjustment	
		Display	Significance
85 °C TOTALPUMPE Display of the operating time of the pump since the initial device startup in hours. The value is shown digit by digit via the indicator lamps. The display is repeated after a pause. Example: The pump has been in operation for 32 hours since the initial device startup. The indicator lamps light up in the following sequence:   PAUSE  			Digit value "0"
			Digit value "1"
			Digit value "2"
			Digit value "3"
			Digit value "4"
			Digit value "5"
			Digit value "6"
			Digit value "7"
			Digit value "8"
			Digit value "9"

6.1.24 Overview of a quick check of the device status

- Read the fault memory in service mode at 53°C. – The operating hours since the last occurrence of the respective fault are displayed for every type of fault.

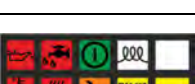
Date:		Part number:	
Customer:		Plant number:	

Display	Significance	Time elapsed since the last occurrence (hours)
	High voltage range	
	Low voltage range	
	Overcurrent	
	Asymmetrical phases	
	Winding protection contact motor is open	
	Lack of water for more than 120 seconds	
	Auxiliary relay for heater is sticking	
	Lack of oil in the oil reservoir	
	Leakage (10 short startups lasting less than 2 seconds)	
	Temperature limiter in the boiler/heater was triggered	
	Temperature sensor short circuit or broken cable	
	RFID electronics defective.	
	End of the fault memory and display of the software version.	

6.1.25 Maintenance intervals

If the orange service indicator lamp illuminates, service needs to be performed.

Time	Maintenance	Activity
Every 400 operating hours	Service boiler	<ul style="list-style-type: none">→ Read the operating hours of the boiler (70°C).→ Reading faults (53°C).→ Drain water.→ Clean the boiler and decalcify.→ Reset the operating hours of the heater since heater service (73°C + SET).
Every 600 operating hours	Service high pressure pump	<ul style="list-style-type: none">→ Read the operating hours of the pump (80 °C).→ Reading faults (53°C).→ Replace the high and low pressure seals.→ Check the valves.→ Check the overflow.→ Oil change.→ Reset the pump operating hours since the last pump service (83°C + SET).
Every 80,000 switches	Gun service	<ul style="list-style-type: none">→ Reading gun switches (60°C).→ Reading faults (53°C).→ Check hand-spray gun→ Check pressure switch.→ Check the overflow valve→ Check the safety valve.→ Reset the gun switches since the last gun service (63°C + SET).

6.2 Adjust the rotating regulator on the pump

Note

The pressure regulator is used to adjust the opening pressure of the overflow valve.

6.2.1 Setting the maximum working pressure

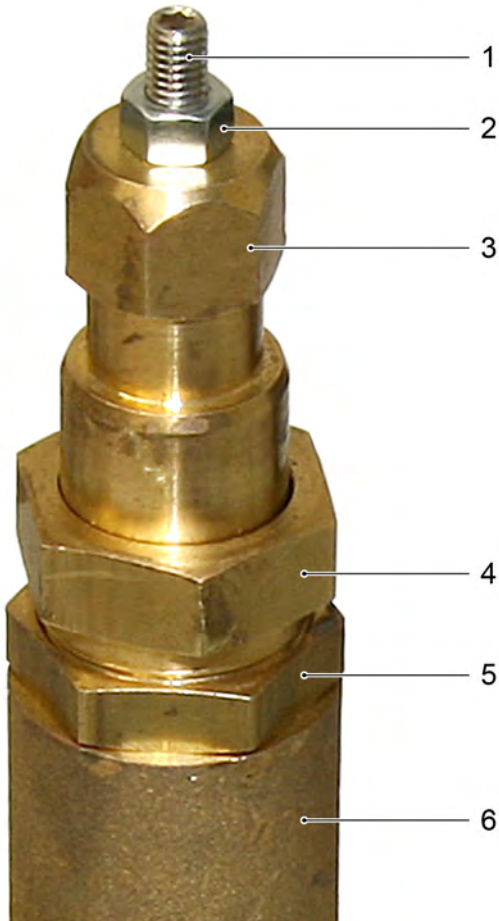

- 1 Adjustment screw, high pressure
- 2 Lock nut, adjustment screw, high pressure
- 3 Spindle, pressure and quantity regulation
- 4 Adjustment screw, low pressure
- 5 Lock nut, adjustment screw, low pressure
- 6 Pump head

- Fasten the test manometer to the high-pressure connection.
- Connect the high-pressure hose and gun to the test manometer.
- Rotate the rotating handle of the pressure regulator on the pump clockwise (direction "+") all the way to the stop.
- Rotate the rotating regulator on the gun to the position of lowest pressure (direction "-").
- Actuate the trigger on the gun and switch on the appliance.
- Pull off the rotary handle on the pressure regulator.
- Loosen the locknut of the adjustment screw for high pressure.
- Turn the adjustment screw high pressure until the opening pressure of the overflow valve of 16.2 to 16.5 MPa (162 to 165 bar) is reached on the test manometer.

Note

Turn in clock-wise direction to increase the working pressure.

Turn in counterclockwise direction to decrease the working pressure.

- Secure the adjustment screw for high pressure by tightening the locknut.
- Check the working pressure, feed volume and switch points of the pressure switches.
- Then seal this setting.

6.2.2 Setting the minimum working pressure

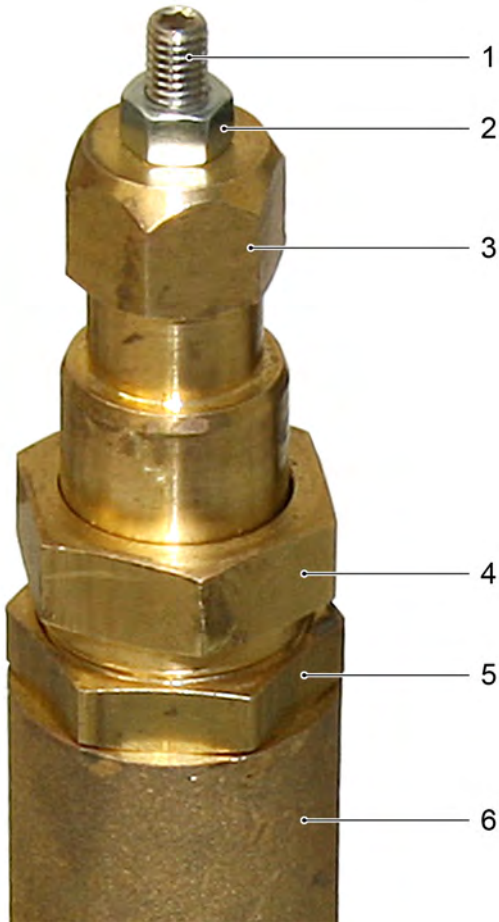

- 1 Adjustment screw, high pressure
- 2 Lock nut, adjustment screw, high pressure
- 3 Spindle, pressure and quantity regulation
- 4 Adjustment screw, low pressure
- 5 Lock nut, adjustment screw, low pressure
- 6 Pump head

- Fasten the test manometer to the high-pressure connection.
- Connect the high-pressure hose and gun to the test manometer.
- Install the **new** high pressure nozzle.
- Rotate the rotating regulator on the gun to the position of highest pressure (direction "+").
- Actuate the trigger on the gun and switch on the appliance.
- Rotate the rotating handle of the pressure regulator on the pump anti-clockwise (direction "-") all the way to the stop.
- Pull off the rotary handle on the pressure regulator.
- Loosen the locknut of the adjustment screw for low pressure.
- Turn the adjustment screw low pressure together with the spindle until the minimum working pressure of the overflow valve of 3.5 to 4.0 MPa (35 to 40 bar) is reached on the test manometer.

Note

Turn in clock-wise direction to increase the working pressure.

Turn in counterclockwise direction to decrease the working pressure.

- Secure the adjustment screw for low pressure by tightening the locknut.
- Check the working pressure, feed volume and switch points of the pressure switches.
- Then seal this setting.

6.3 Remove the manometer

→ Open the operating panel (see "Open operating panel")



- 1 Fastening clip, left
- 2 Pressure hose
- 3 Washer ring
- 4 Manometer
- 5 Fastening clip, right



1 Screwdriver

- Loosen the fastening clip on the right using a screwdriver.
- Pull the manometer out.
- Unscrew the manometer hose if necessary.



→ Loosen the fastening clip on the left behind the manometer using your finger.

6.4 Adjust safety valve

- ➔ Install the shut-off valve with thermometer and manometer (special tool) on the high pressure connection.

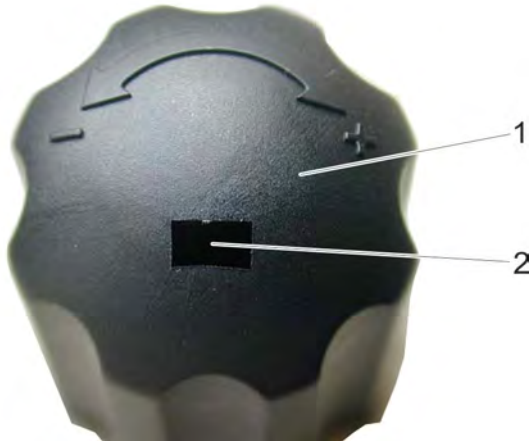

- 1 Rotary knob for pressure and volume regulation
- 2 Release opening

- ➔ Rotate the rotating handle of the pressure regulator on the pump clockwise (direction "+") all the way to the stop.
- ➔ Unlock the rotating handle using a screwdriver and remove it from the pressure regulator.

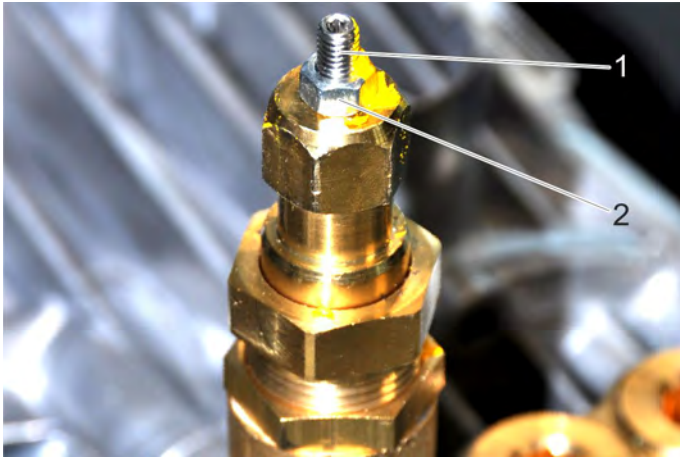

- 1 Adjustment screw, high pressure
- 2 Lock nut, adjustment screw, high pressure

- ➔ Loosen the locknut of the adjustment screw for high pressure.
- ➔ Screw in the high pressure adjustment screw all the way. This blocks the overflow valve.
- ➔ Turn on the appliance.

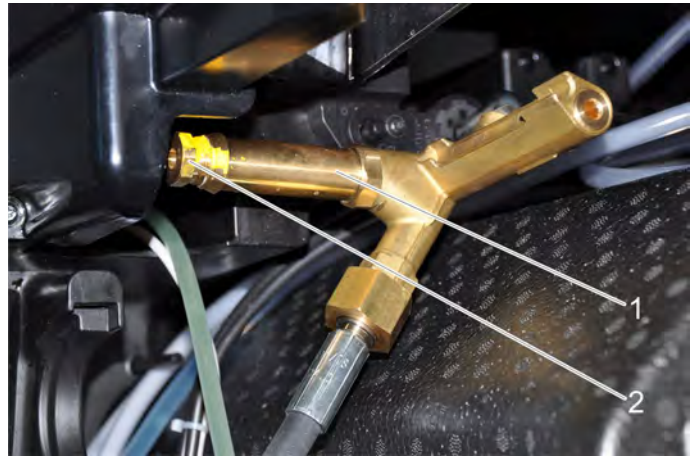

- 1 Safety valve
- 2 Adjustment screw

- ➔ Slowly close the shut-off valve and watch the manometer to see at which pressure the water drips from the outlet of the safety valve.

Target value: 18.5 MPa (185 bar)

- ➔ If the pressure is too high, turn the adjustment screw on the safety valve to the left (relax the pressure spring).
- ➔ If the pressure is too low, turn the adjustment screw on the safety valve to the right (tension the pressure spring).
- ➔ Seal the adjustment screw.
- ➔ Reset the pressure and volume regulation (see "Adjusting the rotating knob on the pump")

6.5 Remove the pump kit

⚠ Danger

Risk of electric shock.

If the appliance is plugged in, there will be voltage supplied to the motor contactor even if the device is switched off!

Adhere to the electrical safety instructions when working on the electrical system of the appliance. Disconnect the appliance from power, secure against inadvertent connection and ensure that no voltage is flowing to the appliance.

→ Remove the device hood (see "Device hood").

→ Remove the cover from the electric box.

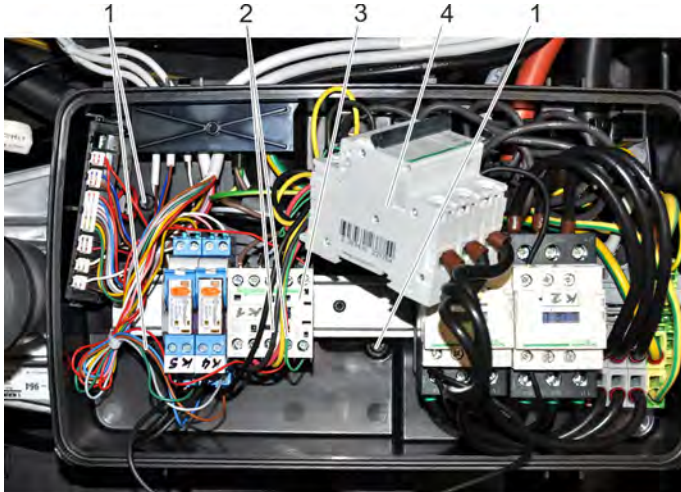

1 Screw

2 Cable from motor

3 Motor contactor, K1

4 Circuit breaker, F1

→ Disconnect the cable from the motor to K1 (red, black, yellow, 2x green) at K1.

→ Disconnect the circuit breaker F1 from the top hat rail.

→ Loosen 3 screws.

→ Disconnect the grounding conductor from the motor at the distributor terminal.

→ Remove the electrical box.



1 Top screw

2 Casing

3 Cover

4 Bottom screw

→ Remove the bottom screws.

→ Remove the lid.

→ Remove the top screws.

→ Remove the housing.

→ Disconnect the connections from the pump head (see "Disassemble high pressure pump/remove pump head").

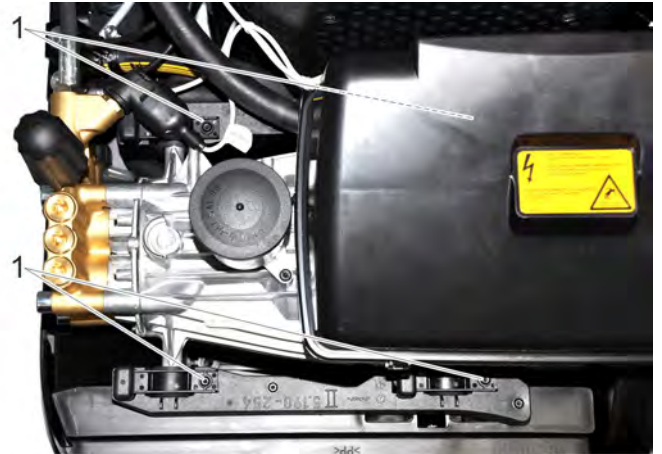

1 Screw

→ Loosen 4 screws.

→ Lift the pump kit from the device.

6.6 Disassemble the high pressure pump

6.6.1 Remove the pump head

Caution

The pump head screws go through the piston guide and are screwed into the motor casing.

If necessary, the piston guide must be secured with two fastening screws prior to removing the pump head as the pump oil may leak otherwise.

Normally, these mounting screws are factory-installed.

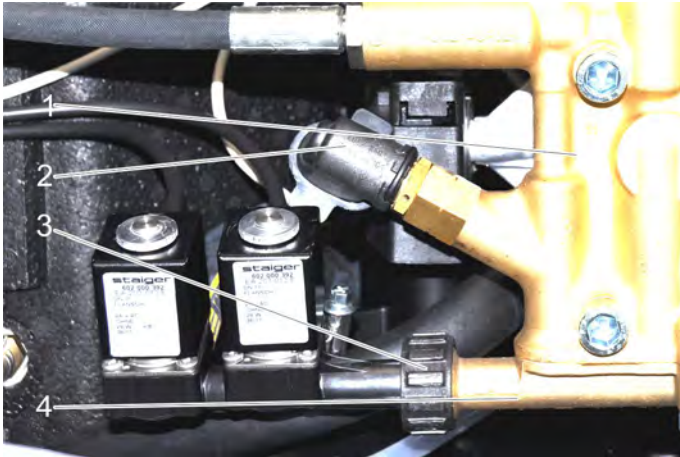

- 1 Pump head
- 2 Pressure switch OFF
- 3 Union joint
- 4 Suction jumper

→ Loosen the union joint and remove the solenoid valves with the supply hose from the suction jumper.

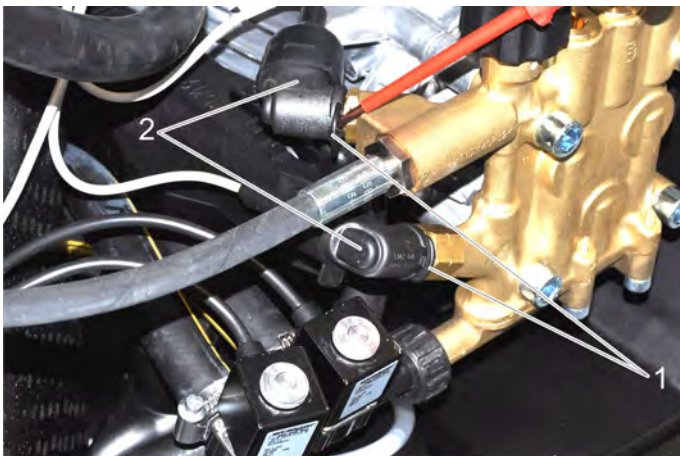

- 1 Retaining clip
- 2 Pressure switch connecting cable

→ Lever IN/OUT the holding clamps of the connecting cables to the pressure switch.

→ Pull the connecting cable of the pressure switch off.

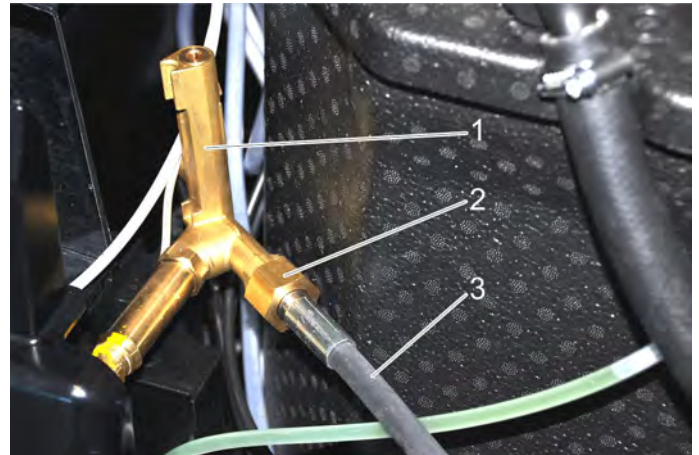

- 1 Safety block
- 2 Union joint
- 3 High pressure hose

→ Loosen the union joint.

→ Remove the high pressure hose from the safety block.

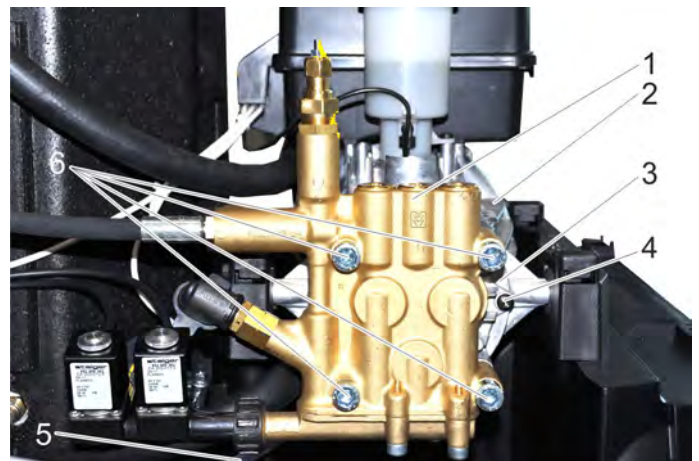

- 1 Pump head
- 2 Motor casing
- 3 Piston guide
- 4 Installation screw
- 5 Suction hose for detergent
- 6 Pump head screws

→ Unscrew pump head screws.

→ Pull off the pump head.

→ Pull the suction hose for detergent from the suction jumper.

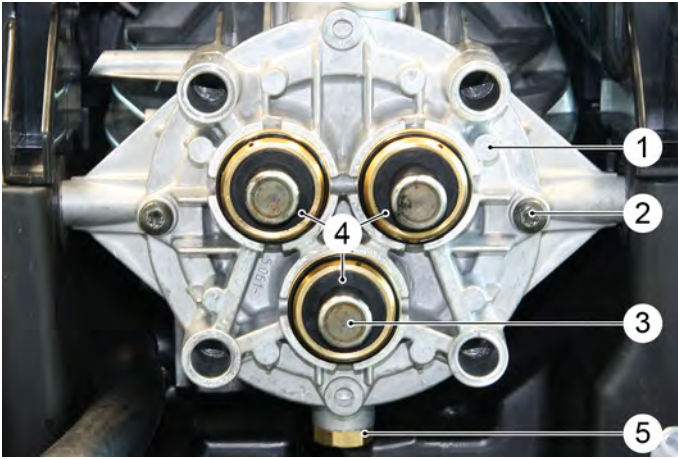

- 1 Piston guide
- 2 Installation screw
- 3 Piston
- 4 Low pressure seal package
- 5 Oil drain screw

➔ Remove the low pressure seal packages from the pistons.

6.6.2 Remove the piston guide and replace the oil seals

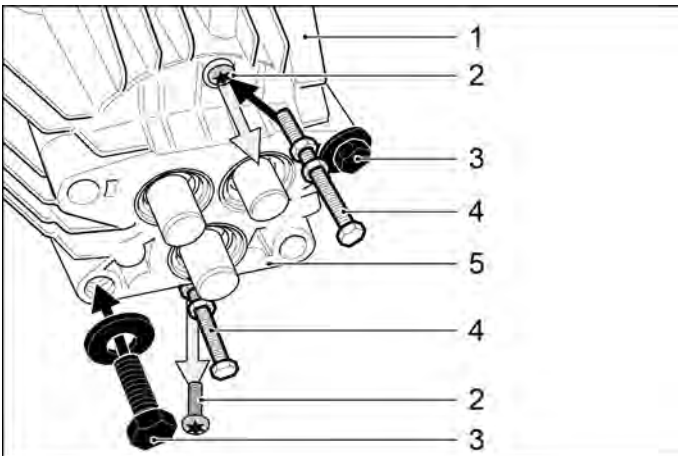

- 1 Motor
- 2 Installation screw
- 3 Lockscrew M8x40 or M12x50
- 4 Auxiliary screw M6x110 with nuts
- 5 Piston guide

⚠ Warning

Do not let gear oil spill into the environment. Please protect the soil and dispose of waste oil in a environmentally-friendly way.

- ➔ Instead of the cylinder head screws, install two lockscrews M8x40 or M12x50 with large washers diagonal across and tighten them.
- ➔ Unscrew the oil drain screw and catch the oil. Unscrew both mounting screws and replace with auxiliary screws M6x110 (special tools).
- ➔ Remove the lockscrews M8x40 or M12x50.

- ➔ Unscrew the mounting screws M6x110 evenly against the pressure of the piston springs. Do not tilt the piston guide during this process.
- ➔ Remove the piston guide and the piston.
- ➔ Check the piston, springs and O-ring for damage; replace if necessary.

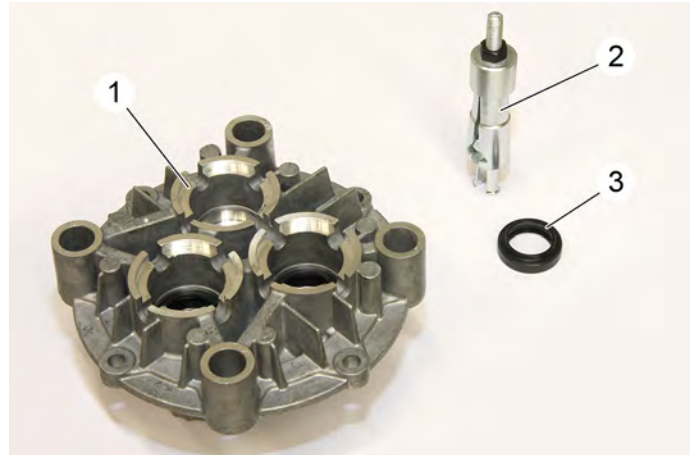

- 1 Piston guide
- 2 Puller tool
- 3 Oil seal

➔ Remove the oils seals with the puller tool.



- 1 Oil seal
- 2 Installation mandrel

Note

Place the new oil seal in water prior to installation.

- ➔ Place the new oil seal onto the installation mandrel (single lip into the groove of the mandrel).

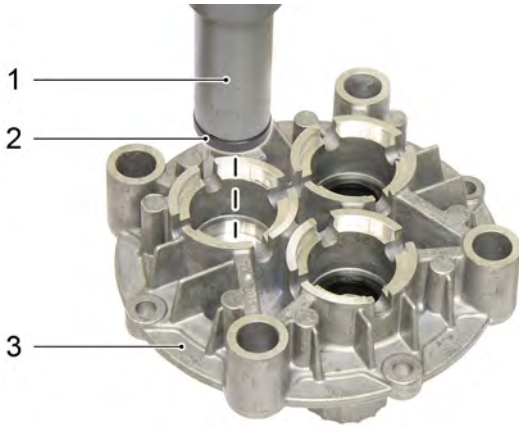

- 1 Installation mandrel
- 2 Oil seal
- 3 Piston guide

➔ Install the oil seal into the piston guide free of oil and grease using an installation mandrel.

6.6.3 Low pressure seal packages

High pressure and low pressure seals consist of a 3-part seal package each.

Note

The installation direction of the low pressure seals in the bushing (see cross section drawings) must be adhered to avoid leaks.

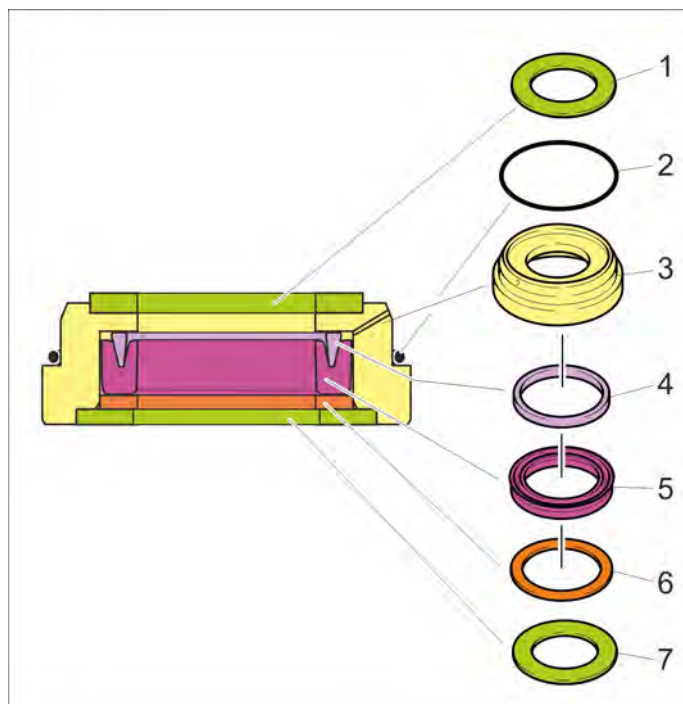

- 1 Plastic washer
- 2 O ring
- 3 Bushing
- 4 Support ring
- 5 Low pressure seal
- 6 Back ring
- 7 Brass support disc

➔ Remove the low pressure seal from the bushing.

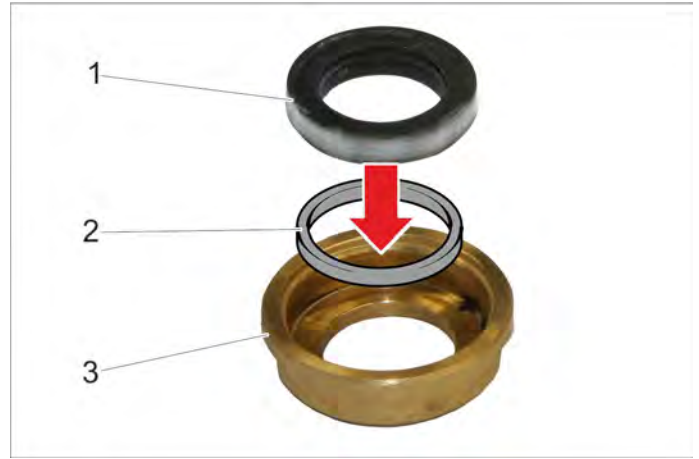

- 1 Low pressure seal
- 2 Support ring
- 3 Bushing

➔ Grease the new support ring and the low pressure seal and install them.

The groove of the seal must point toward the bushing.

➔ Completely assemble the low pressure seal packages.

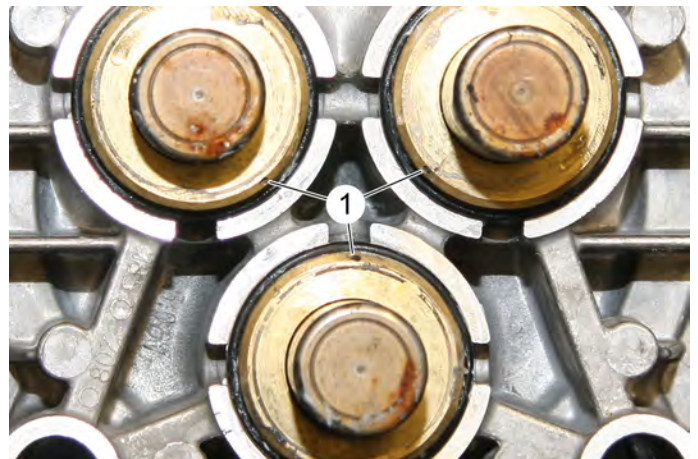

- 1 Holes

➔ Grease the low pressure seal packages and insert them into the piston guide over the pistons.

Align the bores at the chamfers of the bushings toward the centre.

Note:

- High pressure and low pressure seals consist of a 3-part seal package each.
- To increase the standstill time, the following seal packages are available (3-parts each):
Low pressure seal 2.885-236.0
High pressure seal 2.885-237.0
- 3 seal packages are required for each pump.

6.6.4 Replace high pressure seals

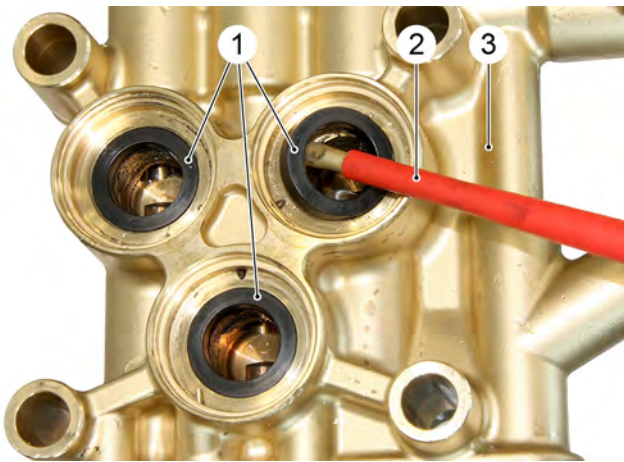

- 1 High pressure seal
- 2 Screwdriver
- 3 Pump head

➔ Remove the high pressure seals.

Note

Grease the new high pressure seal prior to installation.

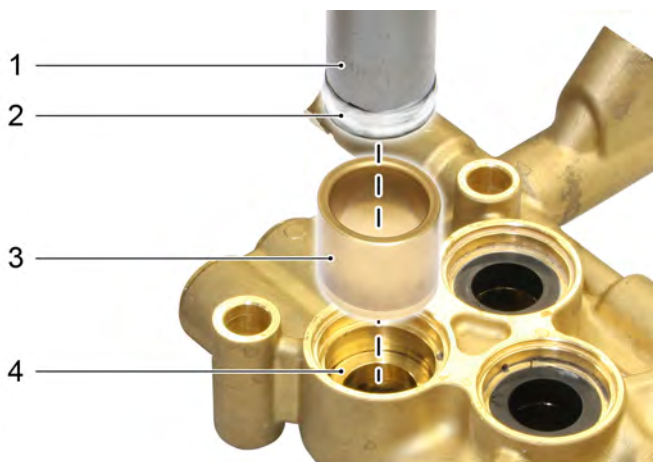

- 1 Installation mandrel
- 2 High pressure seal
- 3 Installation sleeve
- 4 Pump head

- ➔ Place the installation sleeve onto the pump head.
- ➔ Grease the high pressure seal with max. pressure grease.
- ➔ Install the high pressure seal into the piston guide using an installation mandrel into the pump head (observe installation positioning).

6.6.5 Remove the suction jumper, replace the seals and the suction valves

The suction jumper must be removed to replace the suction valves.

Note

For the HDS 5/12, the suction jumper is made of plastic and does not contain a connection for the detergent suction hose.

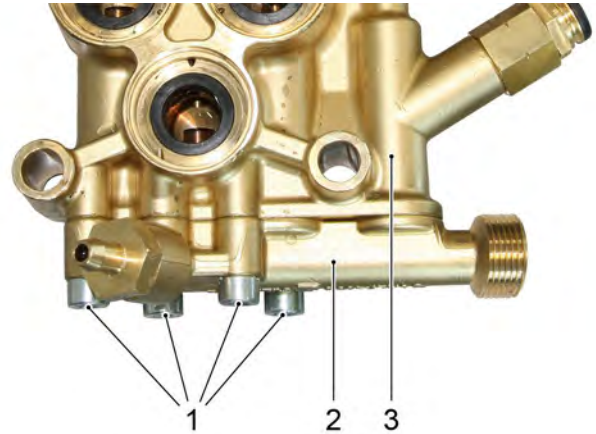

- 1 Fastening screws, suction jumper
- 2 Suction jumper
- 3 Pump head

➔ Unscrew the fastening screws of the suction jumper.

➔ Remove the suction jumper.

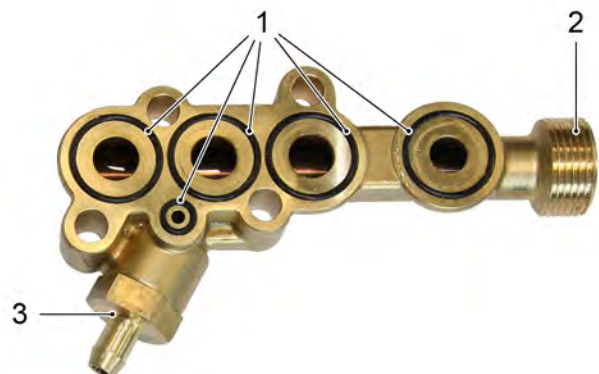

- 1 Seal of suction jumper
- 2 Suction jumper
- 3 Detergent suction hose connection

- ➔ Remove the seals and clean the seal surfaces.
- ➔ Grease the new seals and install them.
- ➔ Unscrew the detergent hose connection, clean it and replace with a new seal.

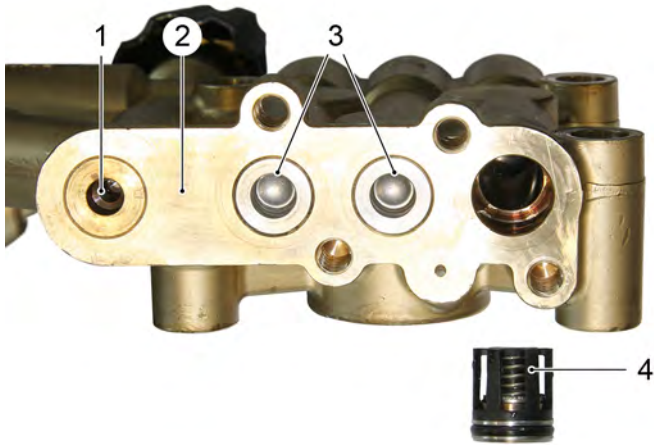

- 1 Sleeve with throttle bore
- 2 Pump head
- 3 Suction valve
- 4 Suction valve (removed)

- ➔ Remove the suction valves using a special pliers.
- ➔ Check the suction valves for leaks.
- ➔ Insert the suction valves (observe installation positioning) with greased seals.
- ➔ Install the suction jumper.

6.6.6 Remove the high pressure valves.

The high pressure valves are secured with valve screws.

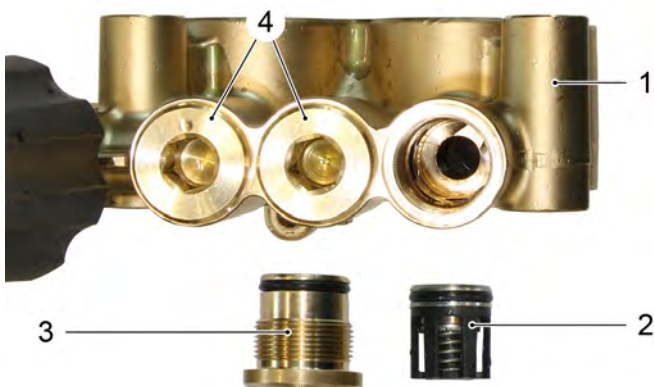

- 1 Pump head
- 2 High pressure valve
- 3 Valve screw
- 4 Valve screw

- ➔ Unscrew the valve screws.
- ➔ Remove the high pressure valves using a special pliers.
- ➔ Check the high pressure valves for leaks.
- ➔ Insert the high pressure valves (observe installation positioning) with greased seals.
- ➔ Screw in the valve screws with new and greased seals.

6.7 Replace the water fine filter.



- 1 Inlet hose
- 2 Water fine filter
- 3 Threaded piece

- ➔ Unscrew the supply line from the water fine filter.
- ➔ Unscrew the casing from of the water fine filter.
- ➔ Take out the filter sieve.

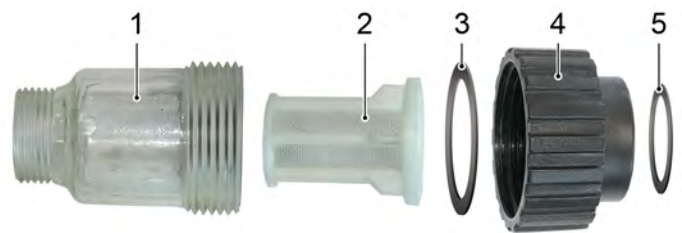

- 1 Filter casing
- 2 Filter sieve
- 3 Flat seal
- 4 Threaded piece
- 5 Flat seal, suction jumper

6.8 Decalcify boiler.

With water with a high calcium content, high heating output and frequent use, there will be increased calcification of the heater and the bottom of the boiler even if you use RM 110.

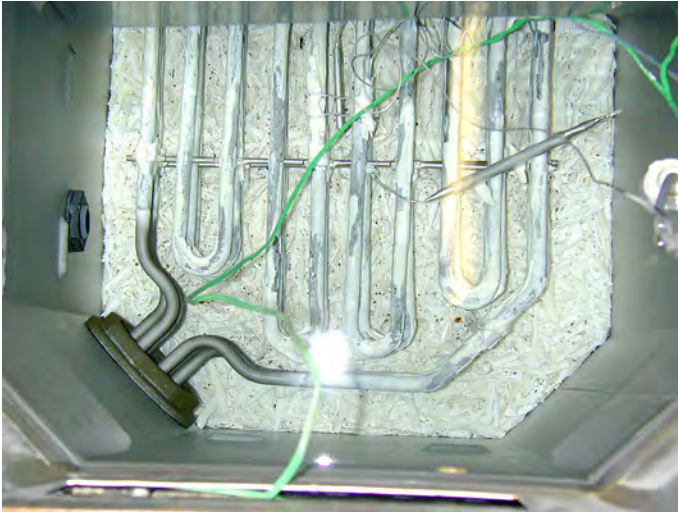

Calcification on the heater and split off calcification residue on the bottom of the boiler in a test device with a heating output of 36 kW, approx. 600 operating hours and approx. 28°dH water hardness.

The boiler must be cleaned and decalcified every 400 operating hours:

- Decalcify the boiler using decalcifier (e.g. RM 101).
- Let lime and acid residue drain via the drain screw.
- Rinse the boiler thoroughly with clear water.
- Neutralise the boiler using alkaline detergent (RM 31, RM 81) or a soda solution (1 kg Soda 6.287-014).

Note:

Due to the standing water, a calcification can only be completely prevented by adding softened, lime-free water.

6.9 Remove boiler

⚠ Warning

Danger of scalding by hot water. After operation with hot water, the device must be operated with openend handgun with cold water for at least two minutes.

- Shut off water supply.
- Let the device run in cold water operation until the boiler and the lines are empty and the lack of water fuse switches the device off.
- Remove the water inlet hose from the appliance.

⚠ Danger

Risk of electric shock.

Adhere to the electrical safety instructions when working on the electrical system of the appliance. Disconnect the appliance from power, secure against inadvertent connection and ensure that no voltage is flowing to the appliance.

- Set the appliance switch to "0/OFF".
- Disconnect the mains plug from the socket.
- Remove the device hood (see "Device hood").
- Unscrew the water fine filter from the boiler.
- Remove the cover with the insulation.

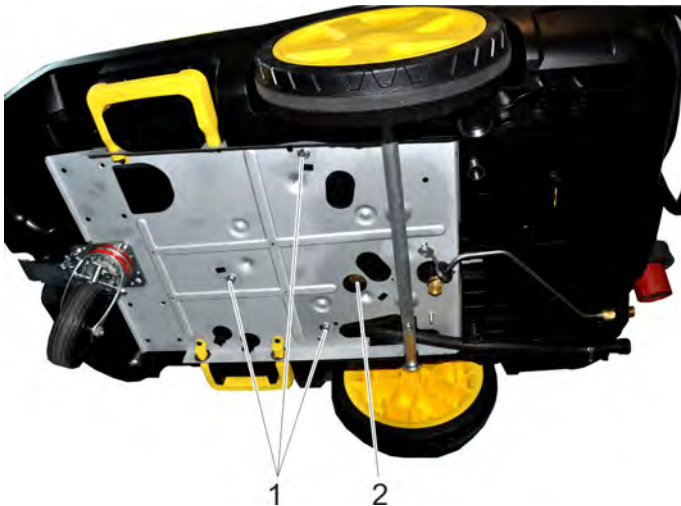

- 1 Boiler fastening screws
- 2 Boiler drain screw

- Loosen the drain screw.
- Drain water.
- Unscrew the fastening screws from the boiler.



- 1 Screw

- Remove two screws.

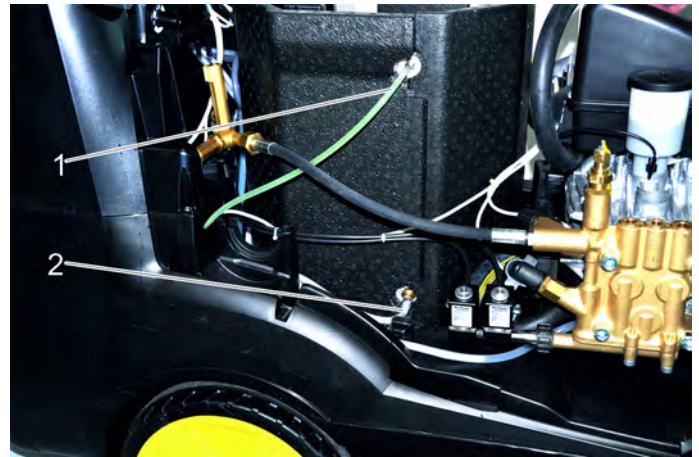

- 1 System care hose
- 2 Rinse hose to the detergent dosing valve.

- Pull the care system hose off the boiler.
- Pull the rinse hose off the boiler.

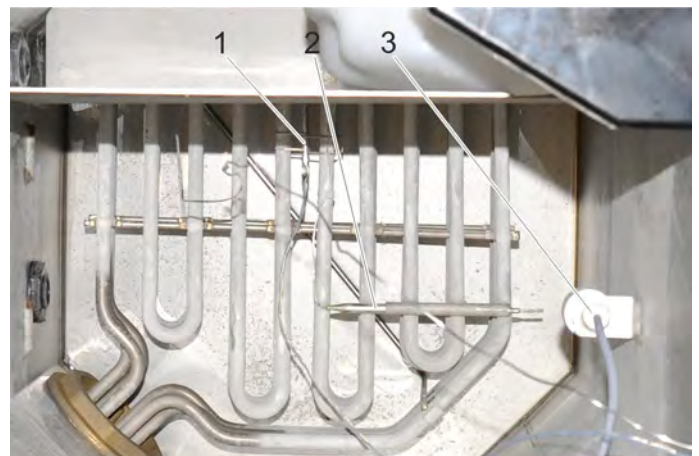

- 1 Temperature sensor
- 2 temperature limiter
- 3 Water shortage safeguard

- Remove the temperature sensor from the heating element.
- Pull the temperature limiter out of the pipe.

→ Unscrew the lack of water protection.

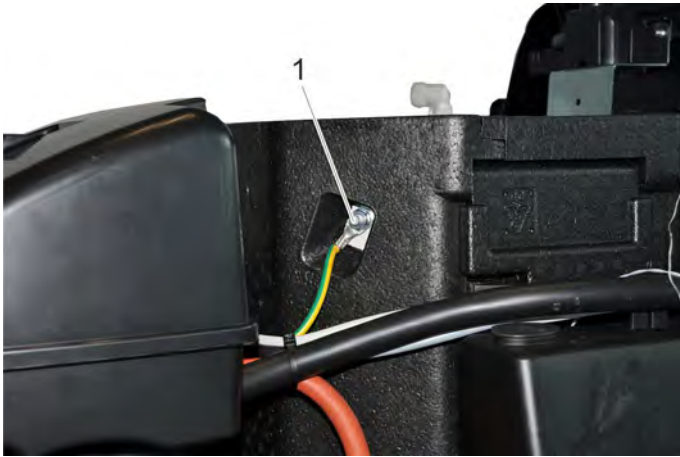

1 Protective conductor connection / earth connection

→ Disconnect the protective conductor connection.

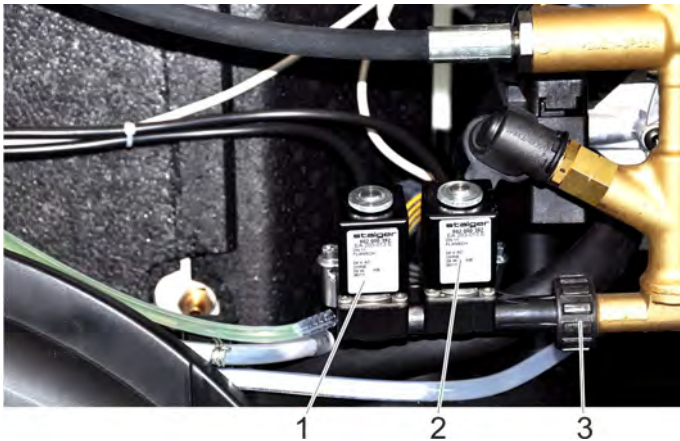

- 1 Solenoid valve for cold water
- 2 Solenoid valve for warm water
- 3 Union joint

- Mark the spools of the solenoid valves in a non-confusable manner.
- Remove the spools from the solenoid valves.
- Unscrew the covering nut.

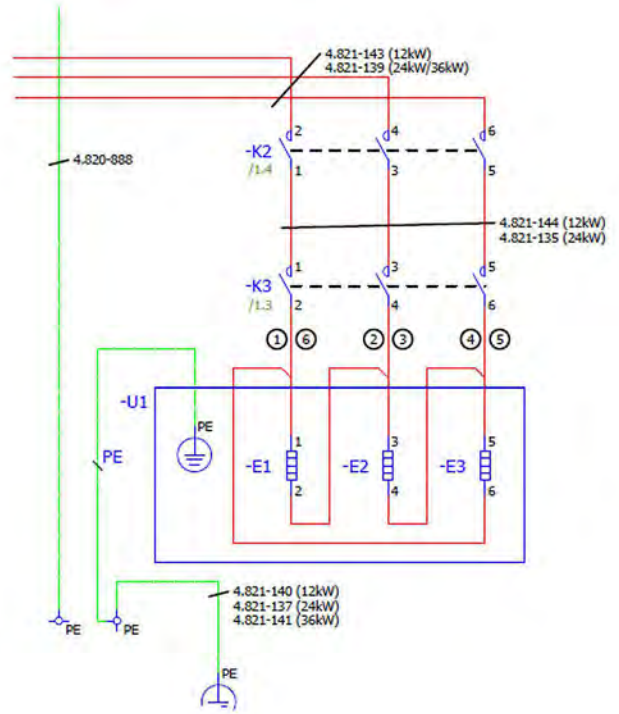

→ Disconnect the cable of the heating element in the electric box.

→ Lift the boiler from the device.

6.9.1 Information for the assembly



- 1 Spring ring
- 2 Lock nut
- 3 Countersinking

→ Insert the spring ring between the knurled nut and the spool.

→ Screw in the knurled nut with the countersinking facing down.

Installation of the boiler in reverse order.

Observe the wire numbers as per circuit diagram when making the electrical connections.

6.10 Removing the heating element

- Remove the boiler (see "Removing boiler").
- Remove the separator walls from the boiler.

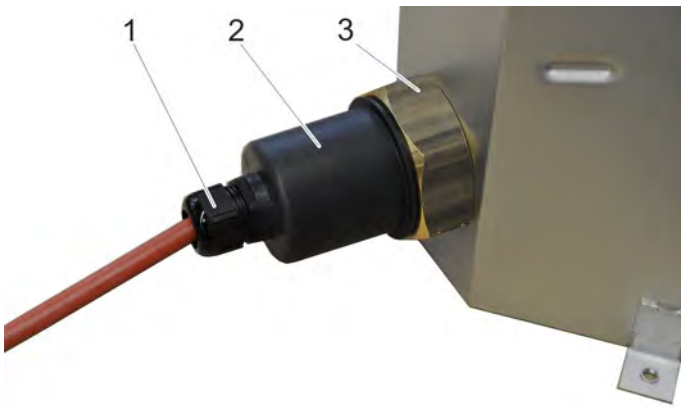

- 1 Cable screw connection
- 2 Splash guard
- 3 Nut

- Loosen the cable screw connection.
- Remove the spray guard.

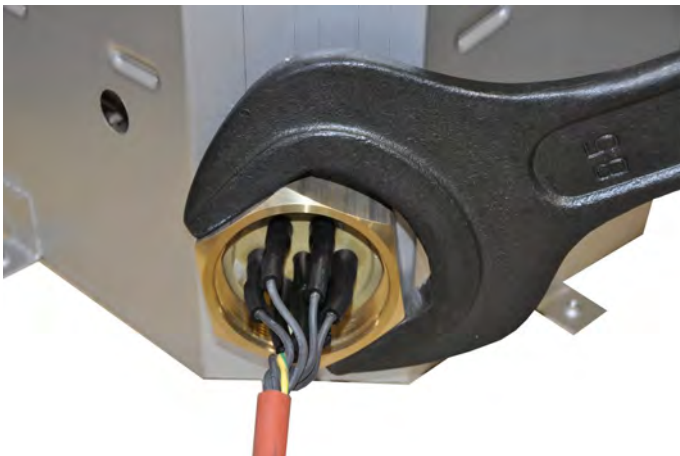

- Unscrew the nut (using an open wrench SW85 or 2" pipe wrench).



- Remove the heating element.

6.10.1 Information for the assembly



- 1 Specifications
- 2 Date of manufacture: Month/Year

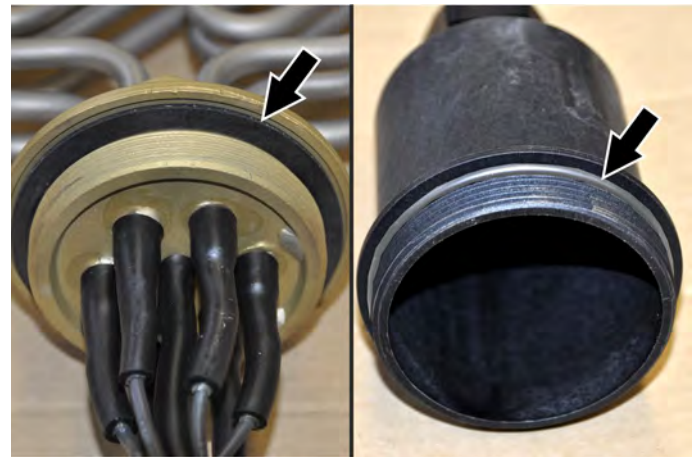

- Check whether all seals have been installed and are seated correctly prior to assembly.

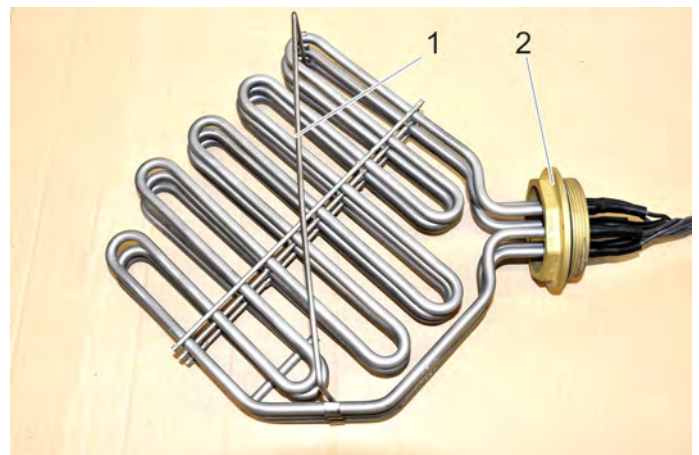

- 1 Spacer
- 2 Flange

- Place the heating element into the boiler so that the spacer is pointing toward the bottom of the boiler.

Note:

The heater and the cables are soldered and cannot be delivered as separate spare parts.

6.11 Remove the rotary switch

⚠ Danger

Adhere to the electrical safety instructions when working on the electrical system of the appliance. Disconnect the appliance from power, secure against inadvertent connection and ensure that no voltage is flowing to the appliance.

6.11.1 Remove the device switch

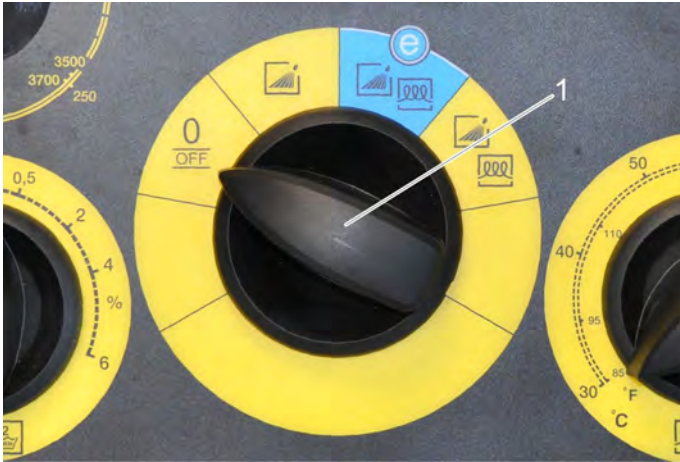

1 Turning handle

→ Pull the rotary handle off the device switch.

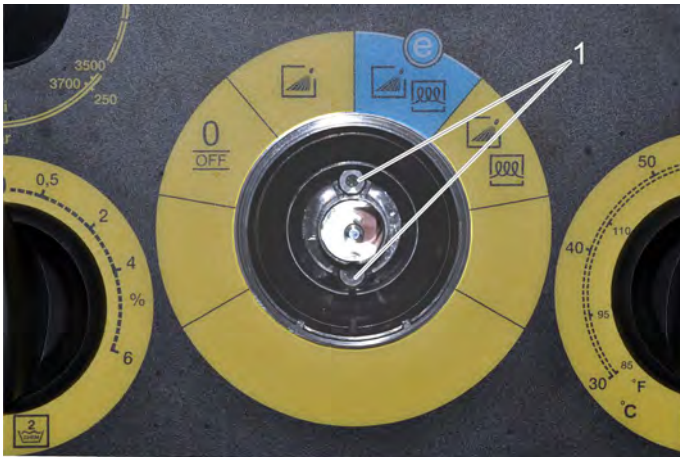

1 Fastening screws

→ Unscrew locking screws.

→ Pull the device switch off toward the inside.

6.11.2 Removing the thermostat

The thermostat is removed in the same fashion as the device switch.



1 Encoding (stop)

Note

The rotation area of the thermostat is limited by the encoding in the rotary handle.

7 Troubleshooting

⚠ Danger

Risk of injury by inadvertent startup of appliance and electrical shock.

Adhere to the electrical safety instructions when working on the electrical system of the appliance.

Disconnect the appliance from power, secure against inadvertent connection and ensure that no voltage is flowing to the appliance.

7.1 Fault display via indicator lamps

See Chapter "Function/operating panel/indicator lamps".

7.2 Appliance is not running

- No power
- ➔ Check power connection/conduit.

7.3 Device is not building up pressure

- Air within the system

Vent pump:

- ➔ Set dosing value for detergent to "0".
- ➔ With open hand spray gun turn device on and off multiple times with the device switch.
- ➔ Open and close the pressure/quantity regulation at the pump unit with the hand spray gun open.

Note: By dismantling the high pressure hose from the high pressure connection the venting process is accelerated.

- ➔ If detergent tank is empty, refill.
- ➔ Check connections and conduits.
- Pressure is set to MIN
- ➔ Set pressure to MAX.
- Sieve in the water connection is dirty
- ➔ Clean sieve.
- ➔ Clean the fine filter; replace it, if necessary.
- Amount of water supply is too low.
- ➔ Check water supply level (refer to technical data).

7.4 Device leaks, water drips from the bottom of the device

- Pump leaky

Note: 3 drops/minute are allowed.

Note: Condensate can cause increased drop generation on the device.

7.5 Device turns on and off while hand spray gun is closed

- Leak in the high pressure system
- ➔ Check high pressure system and connections for tightness.

7.6 Device is not sucking in detergent

- ➔ Leave the appliance running with open detergent dosing valve and closed water supply, until the boiler is sucked empty and the pressure falls to "0".

- ➔ Open the water supply again.

If the pump still is not sucking in any detergent, it could be because of the following reasons:

- Filter in the detergent suck hose dirty
- ➔ Clean filter.
- Backflow valve stuck
- ➔ Remove the detergent hose and loosen the backflow valve using a blunt object.

7.7 Boiler does not heat up

- System care bottle empty.
- ➔ Replace the system care bottle.
- Water shortage
- ➔ Check water supply, check connections.
- Heating element is defective.

7.8 Set temperature is not achieved while using hot water

- Working pressure/flow rate too high
- ➔ Reduce working pressure/flow quantity at the pressure/volume regulator in the pump unit.

8 Technical specifications

Please observe the most current and extended technical specifications in DISIS.

		HDS-E 8/16-4M 12kW	HDS-E 8/16-4M 24kW	HDS-E 8/16-4M 36kW
Main Supply				
Voltage	V	400		
Current type	Hz	3~ 50		
Connected load	kW	17,5	29,5	41,5
Protection (slow)	A	17,5	35	52
Water connection				
Max. feed temperature	°C	30		
Min. feed volume	l/h (l/min)	1000 (16,7)		
Max. feed pressure	MPa (bar)	0,6 (6)		
Performance data				
Water flow rate	l/h (l/min)	710-760 (11,8-12,7)		
Operating pressure of water (using standard nozzle)	MPa (bar)	16,5		
Max. excess operating pressure (safety valve)	MPa (bar)	20,5		
Max. operating temperature of hot water	°C	85		
Switch-off temperature of hot water	°C	98		
Operating temperature during continuous operation with 15 °C input temperature	°C	30	45	57
Detergent suck in	l/h (l/min)	0-30 (0-0,5)		
Heating output	kW	12	24	36
Max. recoil force of hand spray gun	N	37,2		
Nozzle size	--	045		
Values determined as per EN 60355-2-79				
Noise emission				
Sound pressure level L_{pA}	dB(A)	67		
Uncertainty K_{pA}	dB(A)	3		
Sound power level L_{WA} + Uncertainty K_{WA}	dB(A)	85		
Hand-arm vibration value				
Hand spraygun	m/s ²	4,5		
Spray lance	m/s ²	1,9		
Uncertainty K	m/s ²	0,3		
Fuel				
Amount of oil	l	0,75		
Oil grade	--	SAE 90		
Dimensions and weights				
Length x width x height	mm	1330 x 750 x 1060		
Weight without accessories	kg	190	192	197
Detergent Tank	l	10+20		
Total boiler capacity	l	50		
Boiler capacity of pre-heating chamber	l	18	-	-

9 Special tools

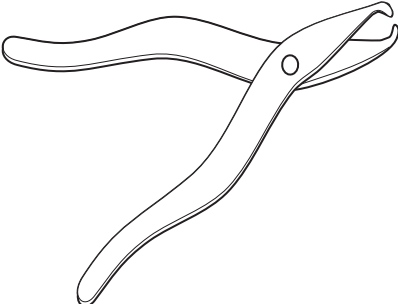
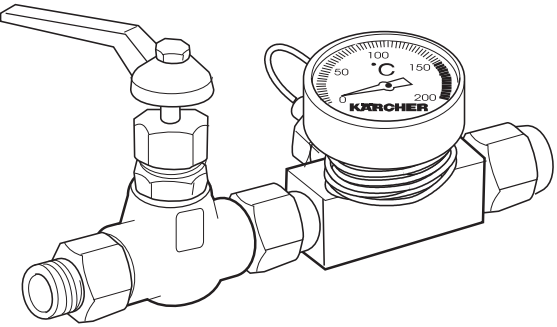
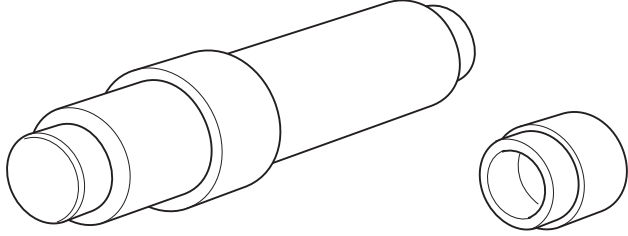
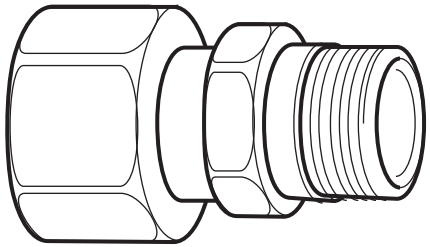
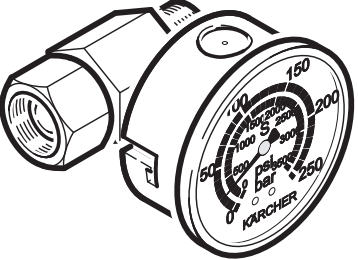
			
<p>Electric measuring appliance</p>	<p>6.803-022.0</p>	<p>Removal pliers, pressure/suction valves and water sieves</p>	<p>4.901-062.0</p>
			
<p>Shut-off valve with thermometer</p>	<p>2.901-030.0</p>	<p>Installation mandrel with sleeve for high pressure/oil seals (D = 18 mm)</p>	<p>2.901-033.0</p>
<p>Ohne Abbildung</p>			
<p>Installation screws, piston guidance (2x M6x110)</p>	<p>7.304-467.0</p>	<p>Adapter system 2000, M22x1.5 with extended acorn nut.</p>	<p>4.401-072.0</p>
		<p>Ohne Abbildung</p>	
<p>Test manometer for working pressure</p>	<p>4.401-072.0</p>	<p>To remove the oil seals: Inner driver, D = 14.5 to 18.5 mm Counter support for inner driver</p>	<p>6.815-013.0 6.815-009.0</p>

10 Torques

Tightening torques in Nm

Pump set	
Pump head	50-60
Piston guide	5-7
Valve screw	40-45
Suction jumper	20-22
Pressure switch	30-35
Connection of detergent hose	30-35
Oil tank	3,5-4
Motor	
Swash plate	12-15
Oil drain screw	20-25
B bearing	9-10
Ventilator casing/motor	2-2,5
Ventilator cover	2-2,5
Fan wheel	12-15
Safety block	
Safety valve	10
Valve seat of safety valve	4
Stopper	15
Miscellaneous	
Rotating regulator/gun	40

11 Circuit diagrams

Note

Please observe the most current circuit diagrams in DISIS.

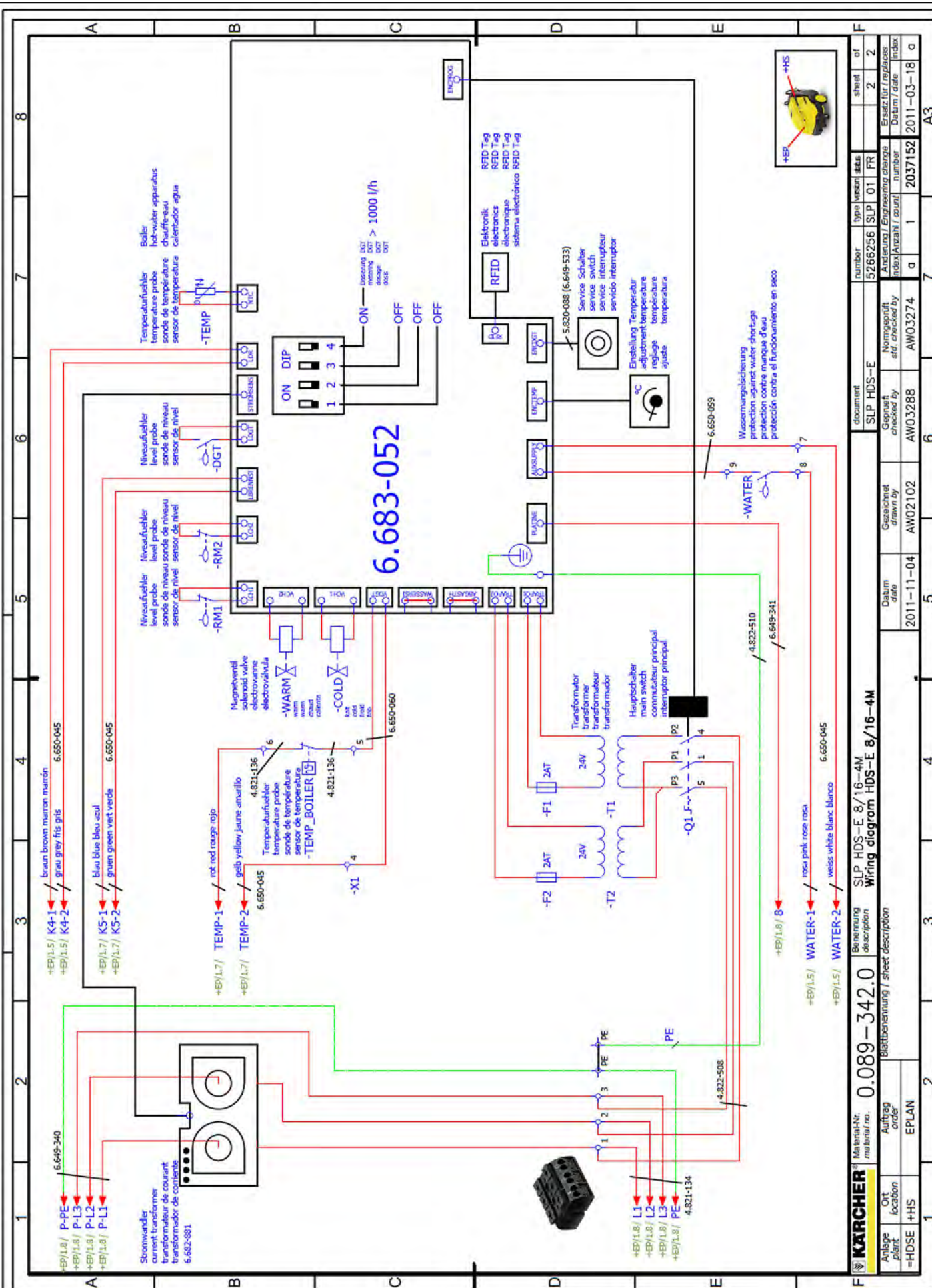

Material no. 0.089-342.0		Drawing description Wiring diagram HDS-E 8/16-4M		document SLP HDS-E		number 3286256		type version SLP 01 FR		sheet of 2 2	
Plant location =HDSE +HS		Order EPLAN		Date 2011-11-04		Checked by AWO2102		Checked by AWO3288		Revision / Date 2037152 2011-03-18	
Index =HDSE +HS		Index EPLAN		Date 2011-11-04		Checked by AWO2102		Checked by AWO3288		Revision / Date 2037152 2011-03-18	

12 Cut-out masks to place on the operating panel

0	1	2	3	4
5	6	7	8	9

0	1	2	3	4
5	6	7	8	9

0	1	2	3	4
5	6	7	8	9

0	1	2	3	4
5	6	7	8	9

0	1	2	3	4
5	6	7	8	9

0	1	2	3	4
5	6	7	8	9

0	1	2	3	4
5	6	7	8	9

0	1	2	3	4
5	6	7	8	9

0	1	2	3	4
5	6	7	8	9

0	1	2	3	4
5	6	7	8	9