

**HDS 7/12 M, HDS 8/18 M,
HDS 9/18 M, HDS 10/20 M,
HDS 12/18 S, HDS 13/20 S
Service Manual**



1 Contents

2	Preface	5
3	Safety instructions	5
3.1	Hazard levels	5
4	Technical Features	5
4.1	General	5
4.2	Connection performance of appliance	5
4.3	Pump	5
4.4	Electronics system	5
4.5	Detergent	5
4.6	Accessories	6
4.7	Field of application	6
4.8	Type plate	6
5	Parts of the system	7
5.1	Front view	7
5.2	View from the back, (device without hose reel)	8
5.3	View from the back, (device with hose reel)	9
5.4	Operator console	10
5.4.1	Control panel with LED indicator	10
5.4.2	Template numerical value display	13
5.4.3	Control panel, view from the inside	15
5.4.4	Printed circuit board, control panel	16
5.4.5	Control panel with display indication (HDS 13/20 only)	17
6	Function	18
6.1	Operating displays	18
6.2	Maintenance operating fluids	18
6.3	Setting liquid softener	19
6.4	SB mode	19
6.5	Storage compartments	20
6.6	Cover	21
6.7	View from the right, cover removed	22
6.7.1	Revised device design (with filter before the pump and electronic ignition transformer)	23
6.8	Service switch	24
6.9	Fuel tank	25
6.10	Liquid softener	26
6.10.1	Feed via tank (export variant)	26
6.10.2	Feed via RFID (Europe variant)	27
6.10.3	Functionality RFID	29
6.11	Swimmer tank	30
6.12	Detergent Tank	31
6.12.1	Detergent tank 1	31
6.12.2	Detergent tank 2	32
6.13	Detergent dosing valve	33
6.14	Motor (air-cooled)	34
6.14.1	Motor (air-cooled)	35
6.15	Electrical box, air-cooled motor	36
6.16	Engine (water-cooled)	37
6.16.1	Engine (water-cooled)	38
6.16.2	Electrical box, water-cooled engine	39
6.17	Pump	40
6.17.1	Revised version with filter before the pump	41
6.18	Safety block	42
6.19	Safety block (water shortage safeguard old)	43
6.19.1	Water shortage safeguard as cartridge	44

6.19.2	Safety block (water shortage safeguard new)	44
6.19.3	Function water shortage safeguard and dry-run protection	45
6.19.4	Function of safety valve	45
6.20	Burner blower with fuel pump	46
6.21	Booster heater (with ignition transformer)	48
6.22	Booster heater (with ignition transformer new)	49
6.22.1	Type plate of heating coil	49
6.22.2	Ignition transformer	50
6.22.3	Flame sensor with holder on the burner	50
6.22.4	Sectional view booster heater	51
6.23	Burner	53
6.24	Burner	54
6.25	Output, booster heater	55
6.26	Hand spraygun	56
6.27	Pressure and volume regulation	57
6.28	Functional diagram of pressure water operation (water-cooled motor)	58
6.29	Functional diagram vacuuming operation	60
6.30	Vacuuming operations	62
6.31	Pressure and volume regulation	63
6.31.1	Function pressure and volume regulation	64
6.32	Functional description of pressure switch	65
6.32.1	Appliance is switched off	65
6.32.2	The appliance is switched on and the gun is open	66
6.32.3	Gun is closed	67
6.32.4	The gun is reopened when the appliance is switched on	68
7	Basic settings and service procedures	69
7.1	Remove the hose drum	69
7.1.1	Uninstall / install high-pressure hose	69
7.1.2	Renew O-rings axle, hose reel	70
7.1.3	Uninstall / install pipeline with axle	72
7.2	Uninstall / install pressure gauge	73
7.3	Adjust safety valve	74
7.4	Service functions with LED display	75
7.5	Set up the switching off process	76
7.6	Set up the leakage behaviour	76
7.7	Brightness value of the flame sensor	77
7.8	RFID query	78
7.9	Testing the temperature sensor	78
7.10	Testing the water temperature setting and the programme switch	79
7.11	Testing the service switch	82
7.12	Testing the sensor	83
7.13	Error memory	84
7.14	Operating hours	86
7.15	Gun switching operations since gun service	87
7.16	Gun services	88
7.17	Gun switches since initial startup	90
7.18	Operation duration of the burner since burner service	91
7.19	Burner service	92
7.20	Burner operation since initial startup	94
7.21	Operating hours of the pump since pump service	95
7.22	Pump service	96
7.23	Pump operation since initial startup	98
7.24	Servicefunktionen mit Displayanzeige	99
7.25	Set up the switching off process	100
7.26	Set up the leakage behaviour	100
7.27	RFID query	101

7.28	Brightness value of the flame sensor	101
7.29	Testing the temperature sensor	101
7.30	Testing the water temperature setting and the programme switch	102
7.31	Test service switch	102
7.32	Testing the sensors	103
7.33	Error memory	104
7.34	Operating hours	106
7.35	Gun switching operations since gun service	106
7.36	Gun services	106
7.37	Gun services since initial startup	106
7.38	Operation duration of the burner since startup	107
7.39	Burner service	107
7.40	Burner operation since initial startup	107
7.41	Operating hours of the pump since pump service	107
7.42	Pump services	108
7.43	Pump operation since initial startup	108
7.44	Quick overview for reading the service functions	109
7.45	Reset of the maintenances	109
7.46	Overview of a quick check of the device status	110
7.47	Settings, burner	111
7.48	Installation air duct on the outer jacket	112
7.49	Adjusting the working pressure with the rotary regulator on the gun	113
	7.49.1 Setting the maximum working pressure	113
	7.49.2 Setting the minimum working pressure	114
7.50	Setting the working pressure with standard gun without rotary knob	115
	7.50.1 Setting the maximum working pressure	115
	7.50.2 Setting the minimum working pressure	116
8	Care and maintenance	116
9	Troubleshooting	117
	9.1 Error messages	118
	9.2 Error message with service demand	119
10	Technical specifications	120
	10.1 Tightening torques	120
11	Special tools	121
12	Circuit diagram	124

2 Preface

Good service work requires extensive and practice-oriented training as well as well-structured training materials. Hence we offer regular basic and advanced training programmes covering the entire product range for all service engineers.

In addition to this, we also prepare service manuals for important appliances - these can be initially used as instruction guides and later on as reference guides.

Apart from this, we also regular information about product enhancements and their servicing.

If you should require supplements, have corrections or questions regarding this document, please address these citing the following subject to:

international-service@de.kaercher.com

Subject: **Fall 105756**

The responsible product specialist will take care of your issue.

Copying and duplication of texts and diagrams as well as third-party access to this information is permitted only with the explicit permission of the company:

Alfred Kärcher GmbH & Co. KG
Postfach 160
71349 Winnenden (Germany)
www.kaercher.com

3 Safety instructions

3.1 Hazard levels

⚠ DANGER

Immediate danger that can cause severe injury or even death.

⚠ WARNING

Possible hazardous situation that could lead to severe injury or even death.

⚠ CAUTION

Possible hazardous situation that could lead to mild injury to persons or damage to property.

4 Technical Features

4.1 General

Mobile hot water high-pressure cleaners in various performance classes for commercial use.

- High performance burner with upright heating coil and continuous ignition
- Built-in calcification protection

- Steam operation (water temperatures up to 155 °C) with separate steam nozzle
- Burner blower and fuel pump directly on the electric motor
- ECO - mode for 60°C (+/- 9 K)

4.2 Connection performance of appliance

- 3,4 kW (HDS 7/12-4 M/MX)
- 5,5 kW (HDS 8/18-4 M/MX)
- 6,4 kW (HDS 9/18-4 M/MX)

- 7,8 kW (HDS 10/20-4 M/MX)
- 8,4 kW (HDS 12/18-4 S/SX)
- 9,3 kW (HDS 13/20-4 S/SX)

4.3 Pump

- 3 piston axial pump with stainless steel piston; some models feature ceramic coating
- Cylinder head made of brass
- High-pressure and suction valve faces made of stainless steel
- Working pressure: 3-20 MPa (30-200 bar)

- Water quantity: 350-1,300 l/h
- Manometer
- Overflow valve with pressure and quantity regulation
- Float tank
- Safety valve
- Water fine filter

4.4 Electronics system

- Program selection switch
- Flame sensor (option)
- Water temperature regulation with temperature sensor
- Exhaust temperature monitor
- Water shortage safeguard
- Dry-run protection for the pump

- Level sensor for fuel, liquid softener and detergent tanks (optional in some cases)
- Operating hour counter
- Error memory
- Component tests
- Fault monitoring
- Monitoring of rotation direction

4.5 Detergent

- 2 detergent tanks
- Detergent inlet with fine filter

- Dosing valve on the device with automatic clear rinsing in zero position.
- Detergent with low pressure and high pressure

4.6 Accessories

- Rotary regulator for pressure and quantity regulation
- Soft grip - easy press gun
- Stainless steel spray lance, rotating
- Power nozzle (stainless steel)
- Steam nozzle (brass)

4.7 Field of application

- HDS 7/12-4 M/MX
- HDS 8/18-4 M/MX
- HDS 9/18-4 M/MX
- HDS 10/20-4 M/MX
- HDS 12/18-4 S/SX
- HDS 13/20-4 S/SX

4.8 Type plate

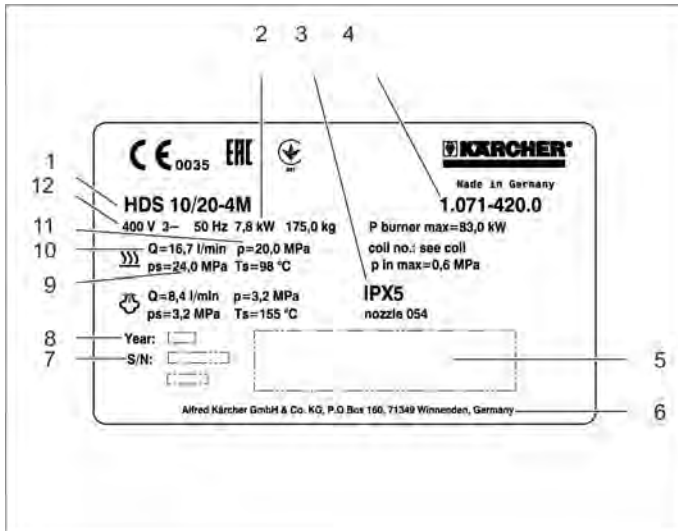

- 1 Appliance description
- 2 Connection output
- 3 Type of protection
- 4 Part number
- 5 Bar code. Contains part and serial number.
- 6 Address of manufacturer
- 7 Serial number
- 8 Year of manufacture
- 9 Max. operating over-pressure
- 10 Flow rate
- 11 Working pressure
- 12 Main Supply

5 Parts of the system

5.1 Front view



- | | | | |
|---|--|----|---|
| 1 | Push handle | 10 | High pressure nozzle |
| 2 | Cover, upper storage compartment | 11 | Transport wheel (2x) |
| 3 | Safety catch, soft grip - easy press gun | 12 | Transport bracket |
| 4 | Rotating regulator | 13 | Steering roller |
| 5 | Hand lever | 14 | Steering roller with fixed position brake |
| 6 | Soft grip - easy press gun | 15 | Chassis |
| 7 | Lock for fuel tank | 16 | Cover |
| 8 | High pressure hose | 17 | Exhaust nozzle |
| 9 | Rotating spray lance | 18 | Lock of appliance hood |

5.2 View from the back, (device without hose reel)

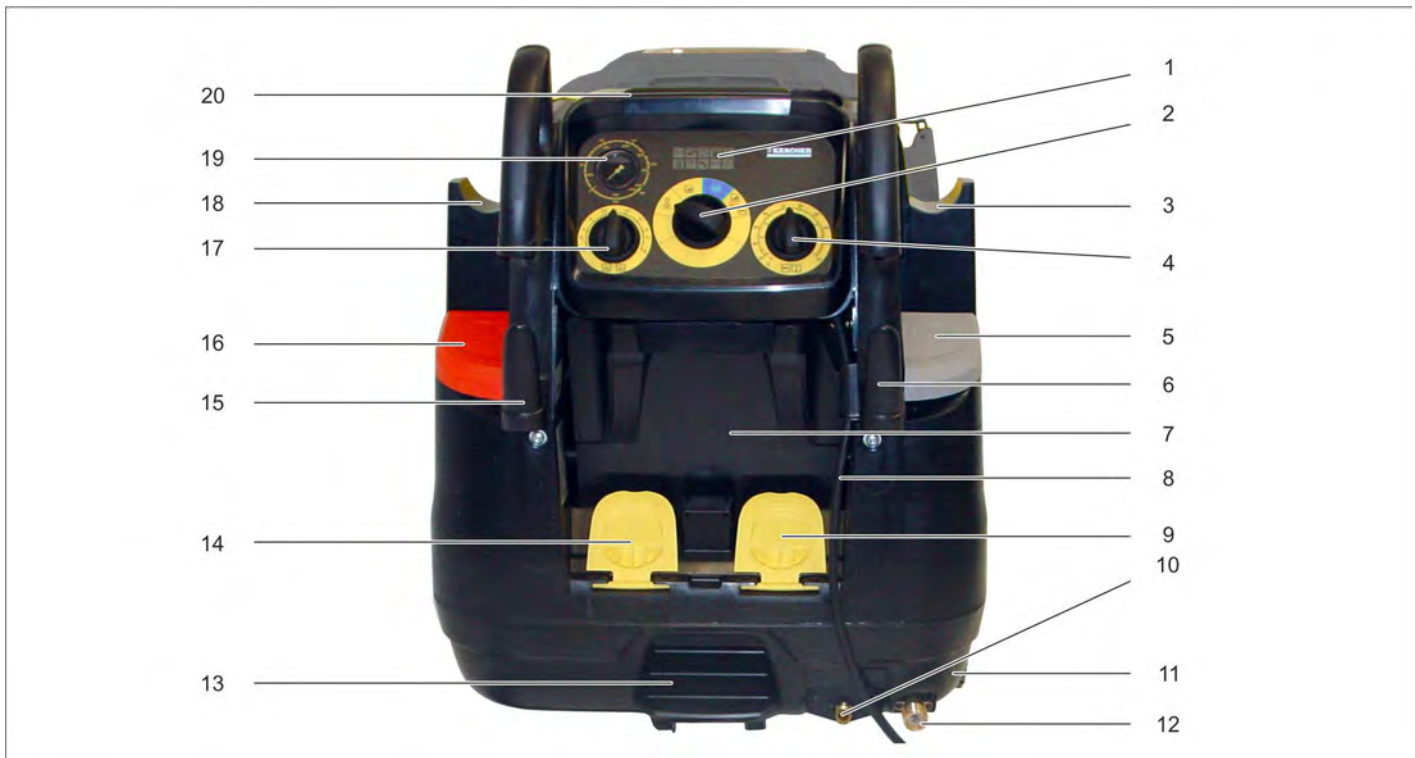

- 1 Indicator lamps
- 2 Programme selector switch (Q1)
- 3 Storage spray pipe
- 4 Setting, water temperature
- 5 Closure, liquid softener tank
- 6 Storage, power cord
- 7 Storage compartment
- 8 Supply Cord
- 9 Closure detergent tank 2
- 10 High pressure outlet
- 11 Chassis
- 12 Water connection with water fine filter
- 13 Tread
- 14 Closure detergent tank 1
- 15 Storage high-pressure hose
- 16 Closure fuel tank
- 17 Setting detergent dosing unit
- 18 Storage spray pipe
- 19 Manometer
- 20 Cover, upper storage compartment

5.3 View from the back, (device with hose reel)

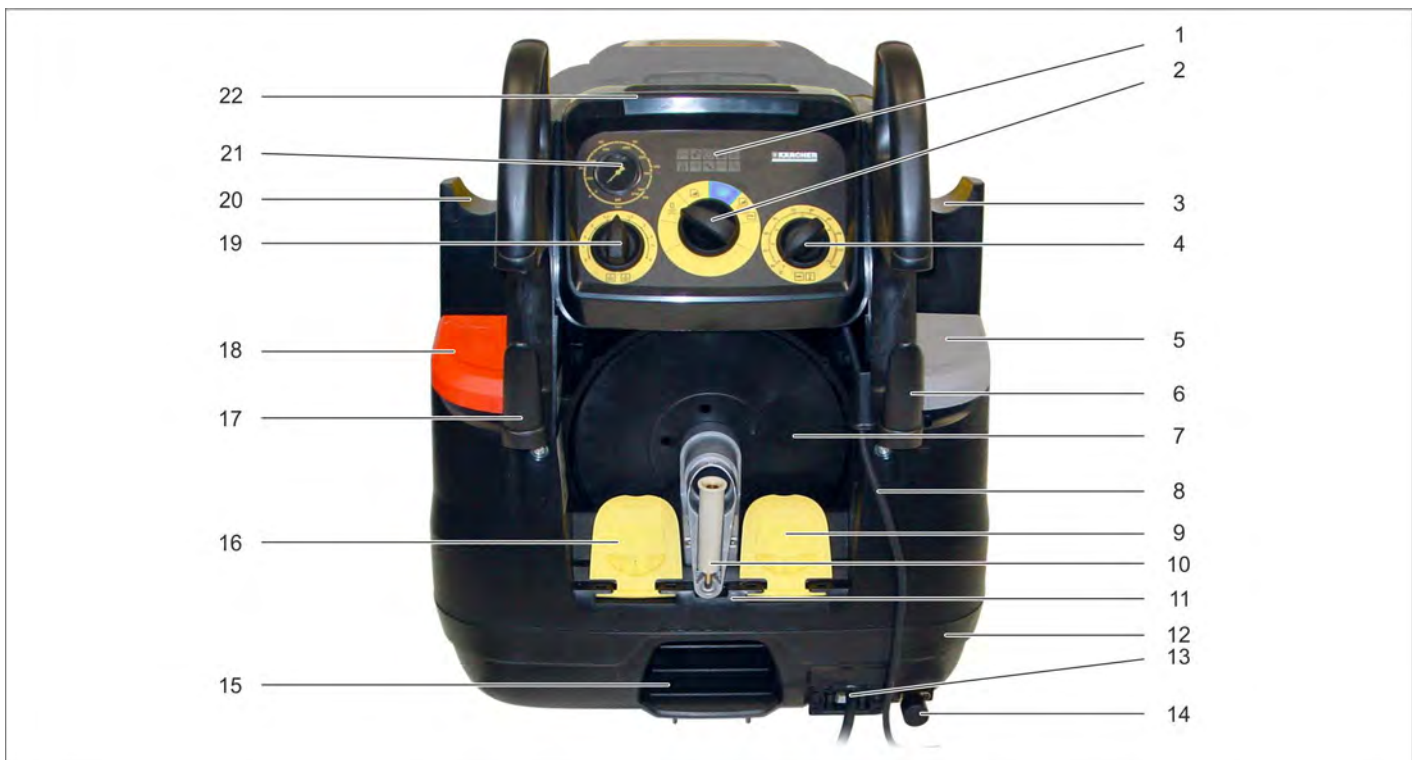

- | | | | |
|----|--------------------------------|----|---|
| 1 | Indicator lamps | 12 | Chassis |
| 2 | Programme selector switch (Q1) | 13 | High pressure hose |
| 3 | Storage spray pipe | 14 | Water connection with water fine filter |
| 4 | Setting, water temperature | 15 | Tread |
| 5 | Closure, liquid softener tank | 16 | Closure detergent tank 1 |
| 6 | Storage, power cord | 17 | Storage high-pressure hose |
| 7 | Hose reel, high-pressure hose | 18 | Lock for fuel tank |
| 8 | Supply Cord | 19 | Setting detergent dosing unit |
| 9 | Closure detergent tank 2 | 20 | Storage spray pipe |
| 10 | Crank, hose drum | 21 | Manometer |
| 11 | Recess hose reel lock | 22 | Cover, upper storage compartment |

5.4 Operator console

5.4.1 Control panel with LED indicator

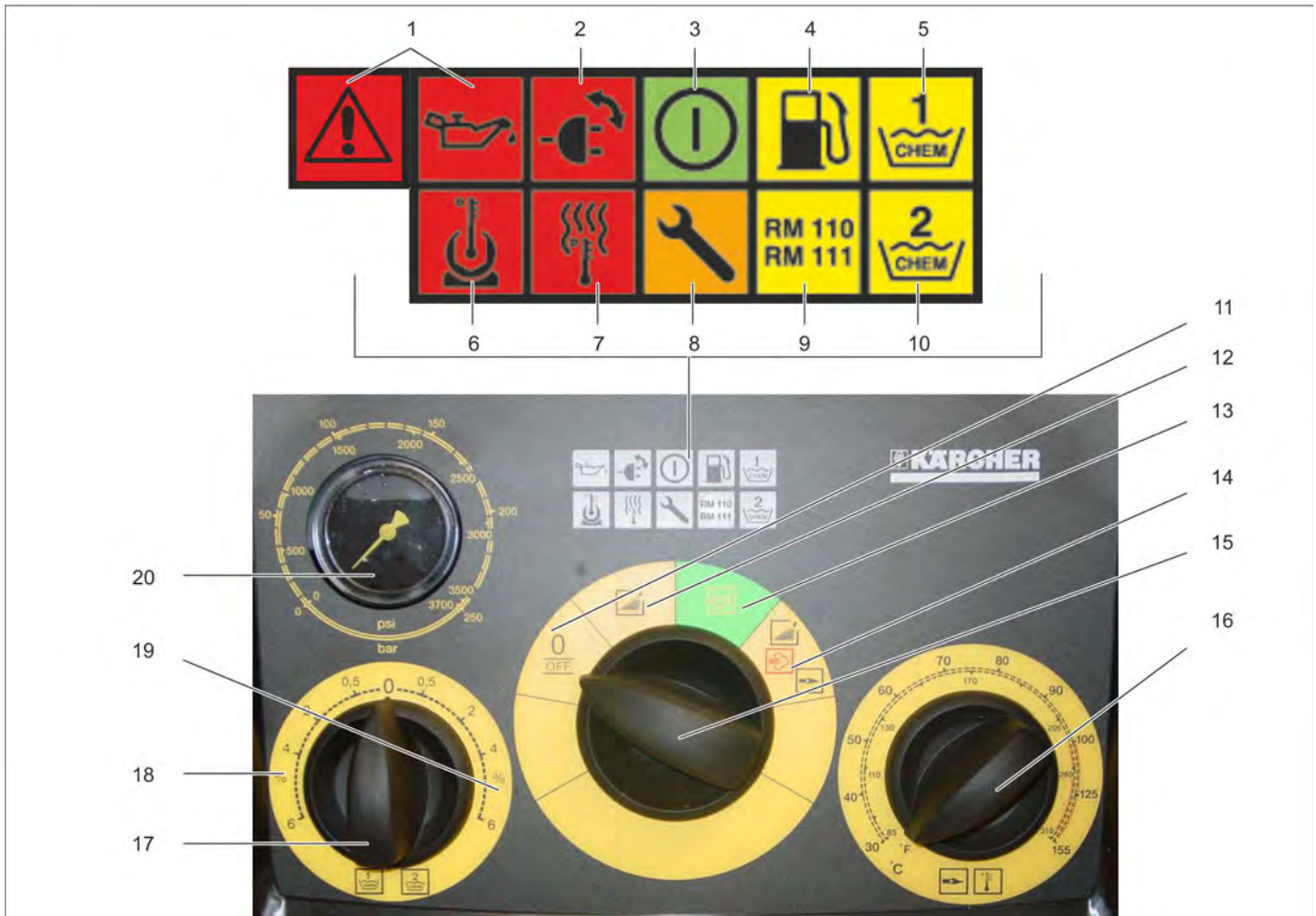

1 Control LED 0, pump (red)

Note

Symbol depending on unit model.

2 Control LED 1, rotation direction (red)

3 Control LED 2, operation (green)

4 Control LED 3, fuel (yellow)

5 Control LED 4, detergent tank 1 (yellow)

6 Control LED 5, motor (red)

7 Control LED 6, burner (red)

8 Control LED 7, service (orange)

9 Control LED 8, liquid softener (yellow)

10 Control LED 9, detergent tank 2 (yellow)

11 Programme switch position "Off"

12 Programme switch position "Cold water operation"

13 Programme switch position "ECO mode"

14 Programme switch position "Hot water / steam operation"

15 Programme switch

16 Setting, water temperature

17 Dosing valve for detergent







18 Dosing range detergent tank 1





19 Dosing range detergent tank 2

20 Manometer

Note

In the "ECO mode" the water temperature is maintained at 60° (+/- 9 K). Set water temperatures < 60°C are effective, <60 ° remain ineffective.

LED no.	Symbol	Activity	Meaning / measure
0	 	1 x blinking	Lack of oil. Check/fill oil level of the high pressure pump; repair leaks.
		2 x blinking	Leakage. 10 short startups. Check the high-pressure system for leaks.
		3 x blinking	Dry running (2 minutes). Check / ensure the water supply.
		4 x blinking	Reed switch or solenoid is sticky. Check safety block/ repair reed switch.
1		1 x blinking	Motor turns in the wrong direction. Switch off the device and turn the phase inverter in the unit plug by 180°.
2		glow	The appliance is now ready for operation.
		1 x blinking	Either the device was in continuous operation for 30 minutes or in standby mode for 30 minutes.
3		glow	Fuel tank empty; fill fuel.
4		glow	Detergent tank 1 is empty. Refill detergent (only HDS 12/18)
5		1 x blinking	Fault in the motor contactor (motor current below 1.5 A for 3 seconds although the contactor has switched). Check / replace the contactor.
		2 x blinking	Coiling protection contact open/defective. Determine/eliminate cause. Replace the engine.
		3 x blinking	Current asymmetry or low voltage or overvoltage. Check the mains connection.
		4 x blinking	Excessive power consumption. Check mechanics for resistance. Check the mains connection.

LED no.	Symbol	Activity	Meaning / measure
6		1 x blinking	Exhaust thermostat open. Check/replace emission temperature/thermostat. Perform maintenance on the burner.
		2 x blinking	Flame sensor reports burner fault. Clean and check the burner, ignition and fuel system.
		3 x blinking	RFID write-read electronics is defective - replace.
		4 x blinking	Fault water temperature sensor. Cable break (temperature below -5°C, although the burner is on) or short circuit (temperature above 220°C for a longer period of time). The device switches off after approx. 10 seconds.
7		glow	Service tasks due: <ul style="list-style-type: none"> - 400h burner - 600h pump - 80000 gun switching operations
8		glow	Softener level switch detects empty condition or the units on the tag of the softener bottle have been consumed.
		1 x blinking	5 hours of after-running time elapsed, burner is locked. Insert new softener bottle.
9		glow	Detergent tank 2 is empty. Refill detergent (only HDS 12/18)

Note

Tag is an electronic component on the new square softener bottle. The tag is located behind the bottle label. The tag can be read and written on electronically (also see 6.10.3 "Functionality RFID").

5.4.2 Template numerical value display

For the better distinguishability of numeric value displays in the service functions the template below can be placed on the LED displays of the control panel.

0	1	2	3	4
5	6	7	8	9

5.4.3 Control panel, view from the inside

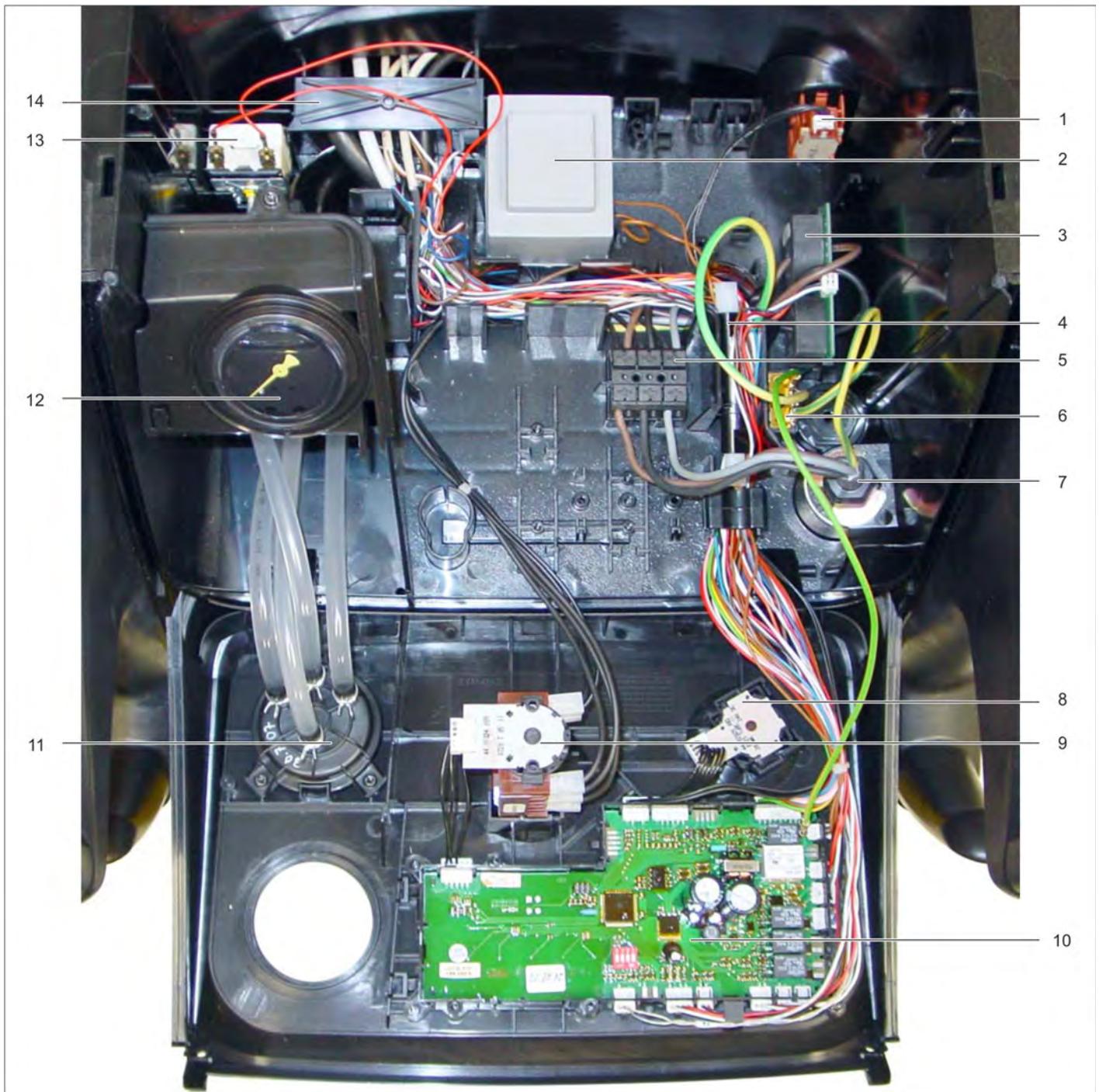

- | | | | | |
|---|---|--------------------|----|-----------------------------|
| 1 | Service switch and dosing liquid softener | | 8 | Setting, water temperature |
| 2 | Control transformer | T1 | 9 | Programme switch |
| 3 | Transducer | | 10 | Control chip |
| 4 | Fuse 2.0 AT for control transformer | AT:
(6.644-052) | 11 | Detergent dosing valve |
| 5 | Terminal strip | | 12 | Manometer |
| 6 | Ground point | | 13 | Exhaust temperature monitor |
| 7 | Supply Cord | | 14 | Cable comb |

5.4.4 Printed circuit board, control panel

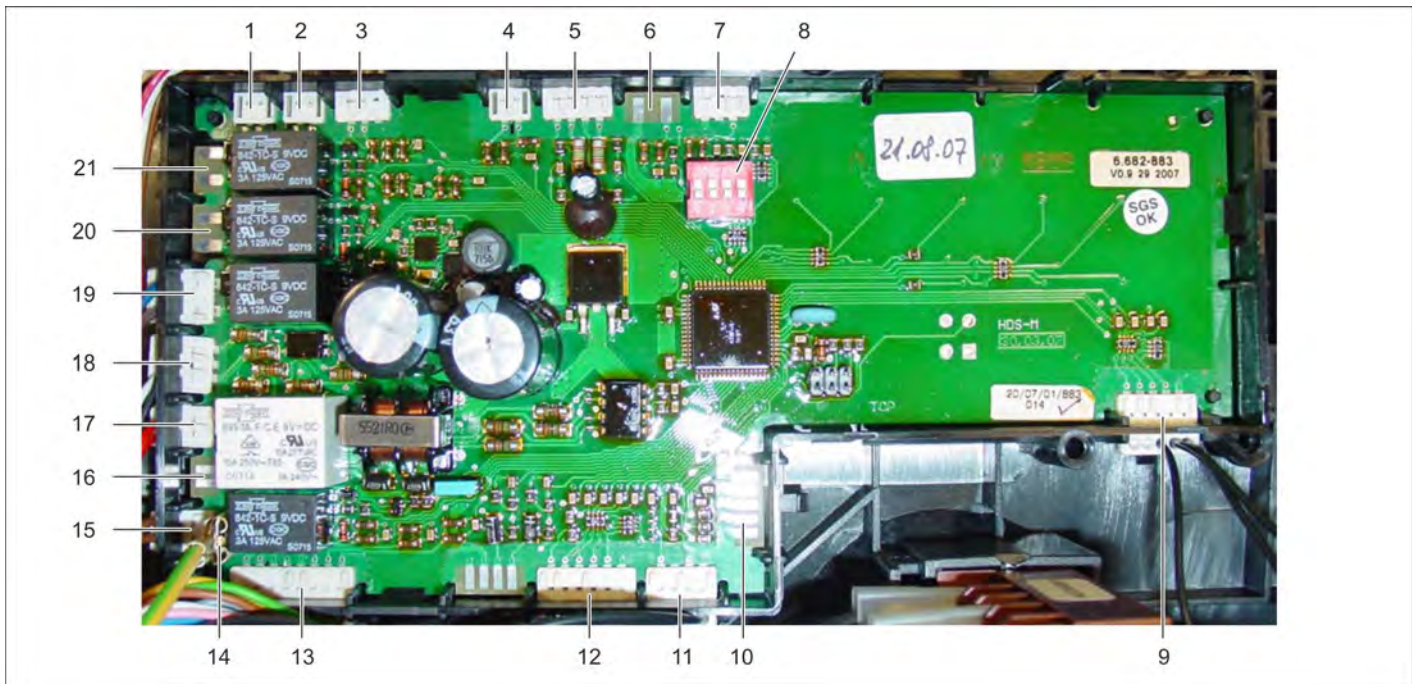

- | | |
|--|---|
| 1 Connection, level sensor detergent tank 1 | 12 Connection water temperature setting |
| 2 Connection, level sensor detergent tank 2 | 13 PCB motor distributor connection |
| 3 Connection of level sensor for fuel tank | 14 Grounding connection control PCB |
| 4 Connection of level sensor for liquid softener | 15 Control transformer T1 connection |
| 5 Transducer connection | 16 Connection control transformer T2 (option) |
| 6 Connection flame sensor | 17 Connection exhaust temperature monitor |
| 7 Temperature sensor connection | 18 Connection, lack of water fuse |
| 8 DIP switch | 19 Connection of solenoid valve for liquid softener |
| 9 Connection programme switch | 20 Connection without function |
| 10 Connection RFID | 21 Connection without function |
| 11 Service switch connection | |

DIP switch

By changing these settings the following functions can be activated:

DIP1 on:

One-phase device

DIP1 off:

Three-phase device

DIP2 on:

With flame sensor.

DIP2 off:

Ohne Flammfühler.

DIP3 off:

Standard setting. Must not be changed.

DIP4 on:

Dosing softener liquid for devices from 1000 l/h onwards

DIP4 off:

Dosing softener liquid for devices up to 1000 l/h

Note

Settings upon delivery in the replacement.

DIP 1 to 3:

Off

DIP 4:

On

– Dosing RM 110/111 via RFID.

Adjust the settings after installation accordingly.

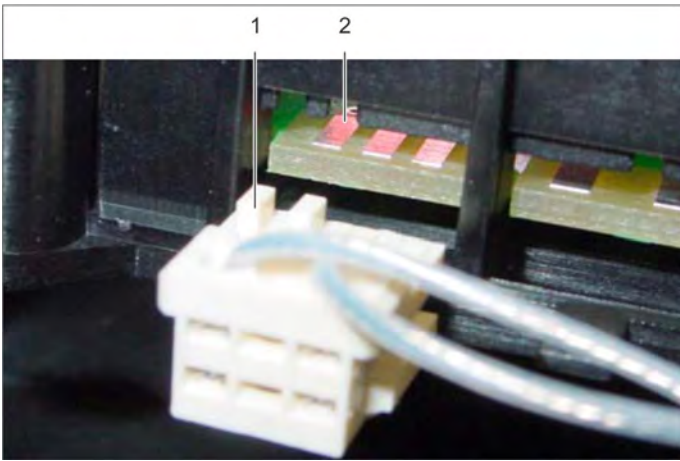

- 1 Encoding pin
- 2 Recess for encoding pin

Plug coding

The plugs for the PCB connections are designed with encoding pins and their matching recesses in the PCB base so that only the matching plug can be attached to the respective connection.

5.4.5 Control panel with display indication (HDS 13/20 only)



- 1 Display
- 2 Programme switch position "Cold water operation"
- 3 Programme switch position "ECO mode"
- 4 Programme switch position "Hot water / steam operation"
- 5 Programme switch
- 6 Setting, water temperature
- 7 Dosage valve for detergent
- 8 Dosing range detergent tank 1
- 9 Dosing range detergent tank 2
- 10 Programme switch position "Off"
- 11 Manometer
- 12 Filling level detergent tank 2
- 13 Filling level detergent tank 1
- 14 Filling level fuel

Note





In the "ECO mode" the water temperature is maintained at 60? (+/- 9). Set water temperatures < 60°C are effective, settings < 60? remain without any effect.

6 Function

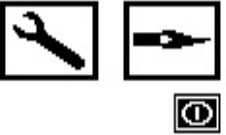

6.1 Operating displays

Note



Operating and maintenance displays are shown one after the other like in a slide show. Each picture for 3 seconds. The fault displays remain until the device is switched off.

Display	Explanation	Remark
	Upper bar: Level fuel (8 stages) Centre bar: Level detergent 1 (4 stages) Lower bar: Level detergent 2 (4 stages) In case of a cable break the relevant bar is not displayed.	
	Maintenance for pump due after 600 h.	Perform maintenance procedure. Reset pump hours.
	Maintenance for burner due after 400 h.	Perform maintenance procedure. Reset burner hours.
	Maintenance for accessory due after 80000 gun switching operations.	Perform maintenance procedure. Reset gun switching operations.

6.2 Maintenance operating fluids

Display	Explanation	Remark
	Empty liquid softener.	Insert new bottle.
	The bottle of the liquid softener is missing or the 5 hours after-running time have elapsed. The burner is locked.	Insert new bottle.
	Oil refill container HP pump is empty.	Replenish oil.

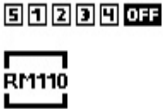
6.3 Setting liquid softener

Display	Explanation	Remark
	<p>Set liquid softener dosing in accordance with the water hardness.</p> <p>This display appears for 3s if the liquid softener setting is changed.</p>	
	<p>Attention service mode position. After the restart, the device will be in the service mode.</p> <p>This display remains until another liquid softener setting is selected.</p>	

6.4 SB mode

Display	Explanation	Remark
	<p>Insertion of money required.</p>	<p>Only with operation with SB board.</p>

6.5 Storage compartments

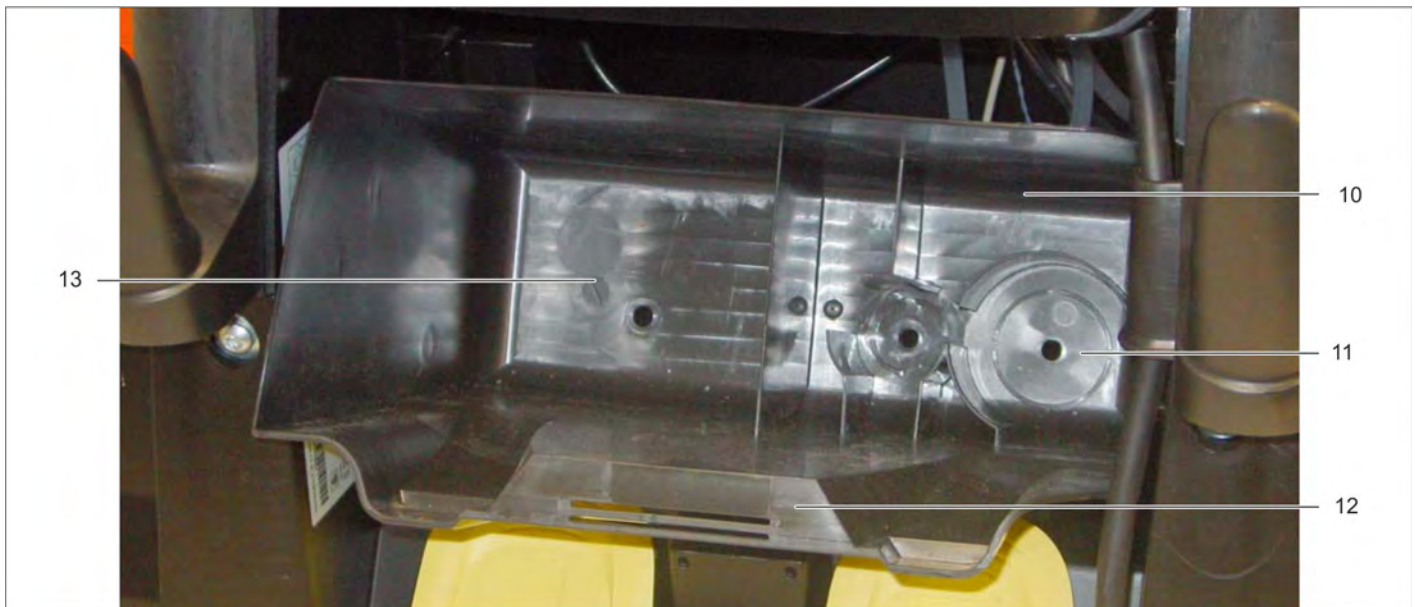
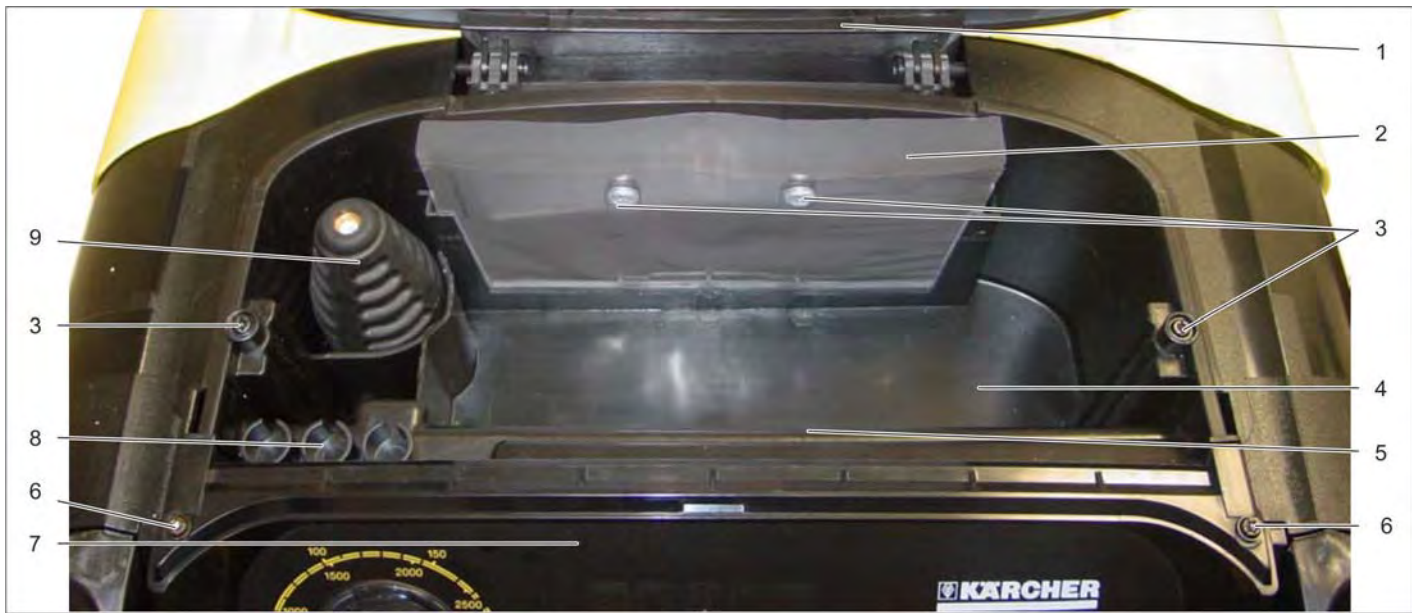

- | | |
|---|---|
| 1 Cover, upper storage compartment | 8 Storage replacement nozzles |
| 2 Storage operating instructions | 9 Storage dirt grinder |
| 3 Fastening screws upper storage compartment (4x) | 10 Storage compartment bottom |
| 4 Storage compartment top | 11 Bottle holder for round liquid softener bottle or detergent bottle |
| 5 Nameplate | 12 Recessed grip |
| 6 Fastening screw control panel | 13 Bottle holder for two RFID liquid softener bottles |
| 7 Operator console | |

6.6 Cover

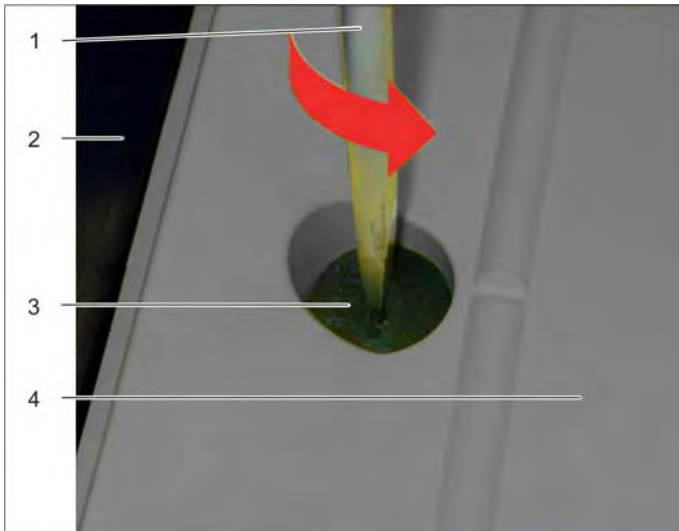

Note

Open cover and dismantle if necessary

- 1 Screwdriver
- 2 Storage compartment top
- 3 Lock of appliance hood
- 4 Cover

- ➔ Push in the locking mechanism of the cover and turn it by 90°.
- ➔ Open the appliance hood.

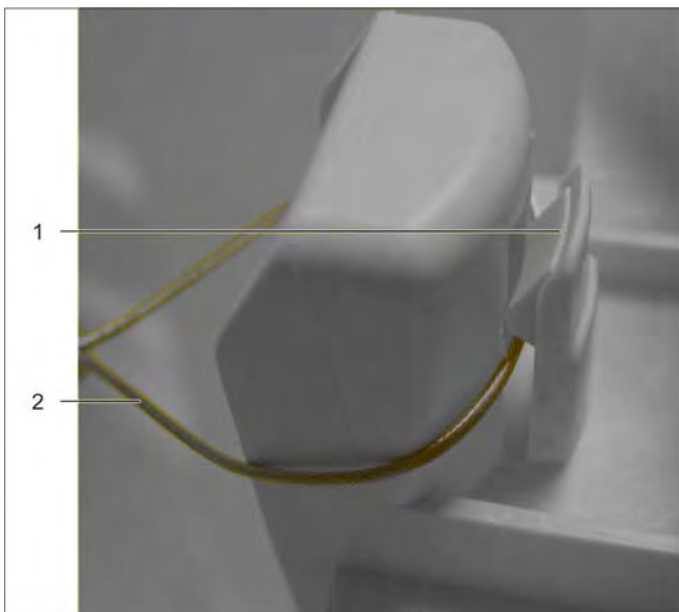

- 1 Locating lug arrestor cable
- 2 Arrestor cable cover

- ➔ Unhook the arrestor cable from the locating lug.

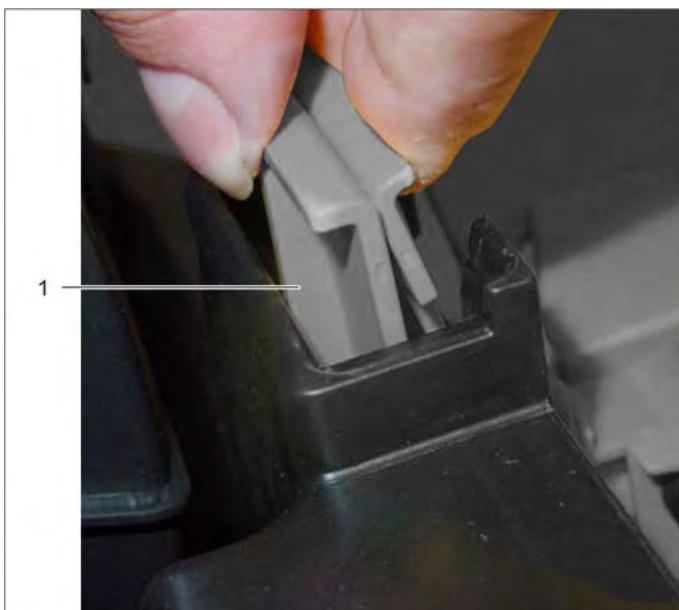

- 1 Hinge cover (2x)

- ➔ Unclip hinges.
- ➔ Remove the appliance cover.

6.7 View from the right, cover removed

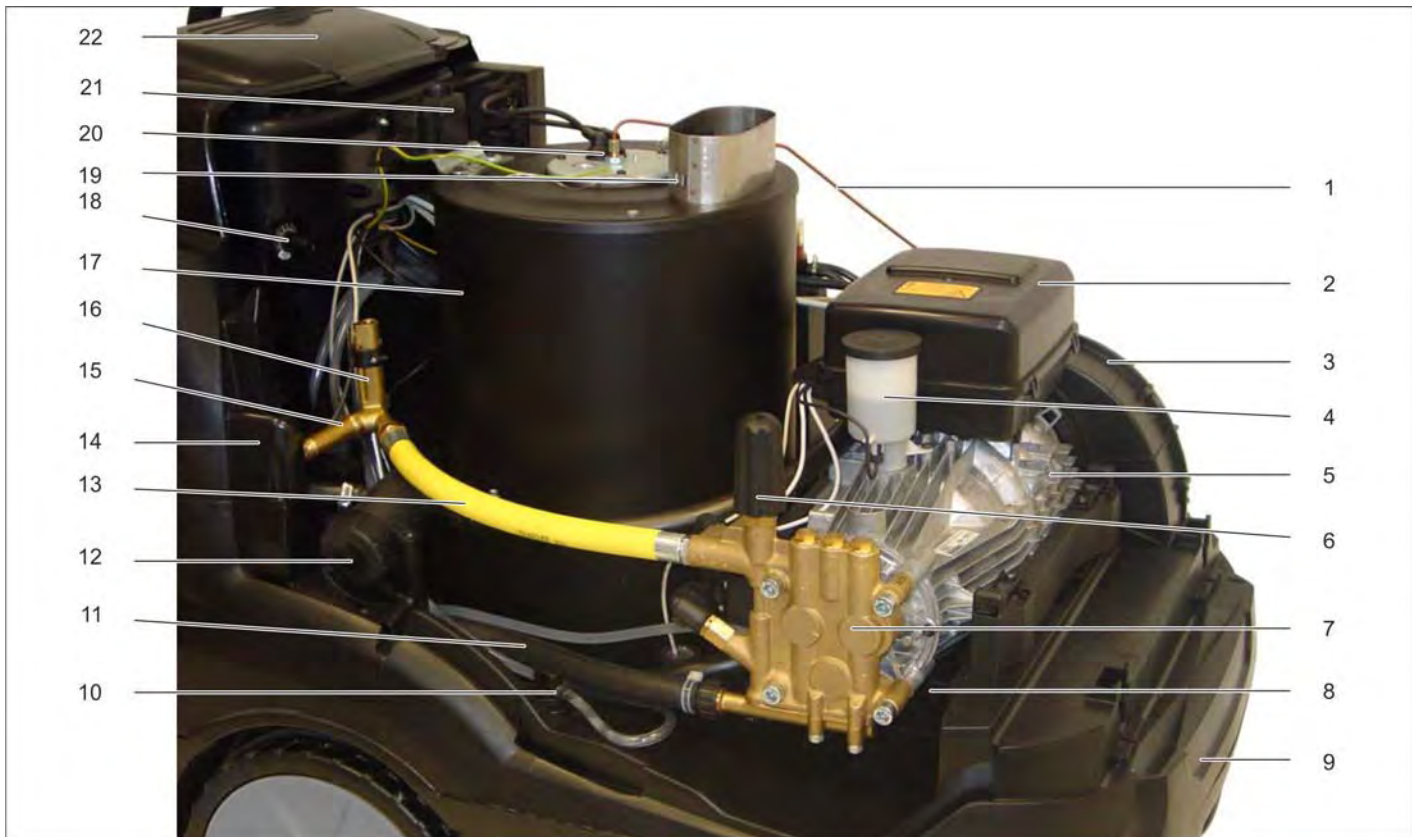

1 Fuel line to the booster heater

2 Electric box, motor

3 Burner blower

4 Oil refill container pump

5 Motor

6 Handle, pressure and volume regulation

7 Pump head

8 Oil drain screw

9 Chassis

10 Plug detergent tank 2

11 Water hose to the pump

12 Casing water fine filter

13 SDS hose to the safety block

14 Splashboard, safety valve

15 Safety valve

16 Water shortage safeguard

17 Continuous heater

18 Service switch and setting liquid softener

19 Exhaust nozzle, on-demand heater

20 Burner, booster heater

21 Locking block cover

22 Cover, storage compartment top

6.7.1 Revised device design (with filter before the pump and electronic ignition transformer)

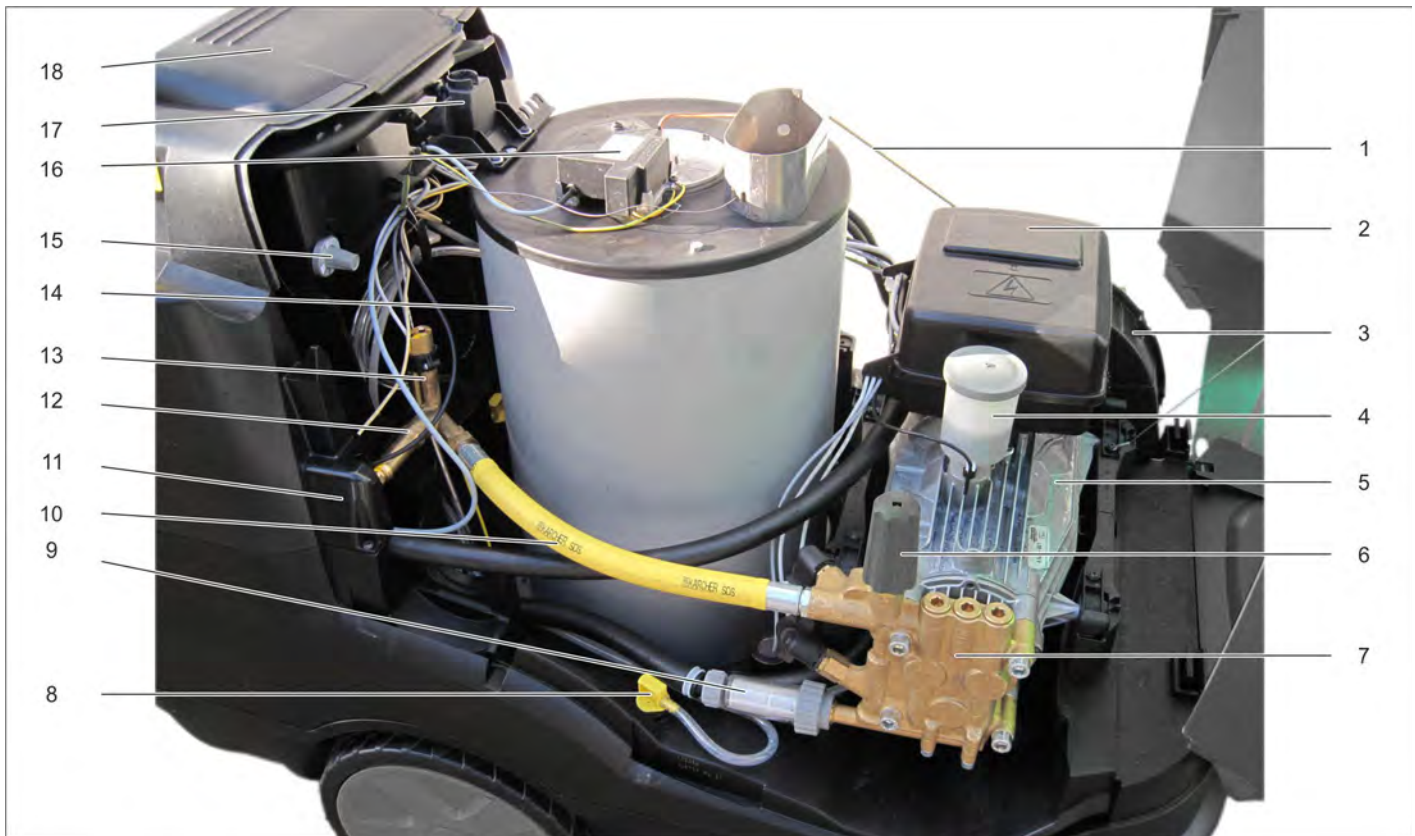

1 Fuel line to the booster heater

2 Electric box, motor

3 Burner blower

4 Oil refill container pump

5 Motor

6 Handle, pressure and volume regulation

7 Pump head

8 Plug detergent tank 2

9 Filter

10 SDS hose to the safety block

11 Splashboard, safety valve

12 Safety valve

13 Water shortage safeguard

14 Continuous heater

15 Service switch and setting liquid softener

16 Burner, booster heater

17 Locking block cover

18 Cover, storage compartment top

6.8 Service switch



- 1 Position marking
- 2 Service switch

Setting the water hardness

The setting of the liquid softener dosing is done in accordance with the local water hardness (ask your local water supply company or determine by means of a hardness tester).

Hardness tester	6.768-004.0
-----------------	-------------

Water hardness	Adjustments	° dH
very soft	OFF position	up to 3.0
soft	Position 1	3,1 - 7,0
medium	Position 2	7,1 - 14,0
hard	Position 3	14,0 - 21,0
very hard	Position 4	> 21,0

Note

When using RM 111, do not fall below position 3. Observe setting DIP 4 on the printed circuit board.

Service position

In the "Service" position the settings of the device can be edited by means of the service switch and the control panel.

From the "Service" position, the service switch can be turned a little further to the "SET" position. From this position, the switch returns to the "Service" position after releasing it. The "SET" position merely fulfils a pushbutton function.

Note

The setting options are described in Chapter 7.4 or 7.24 "Service functions with LED display".



6.9 Fuel tank

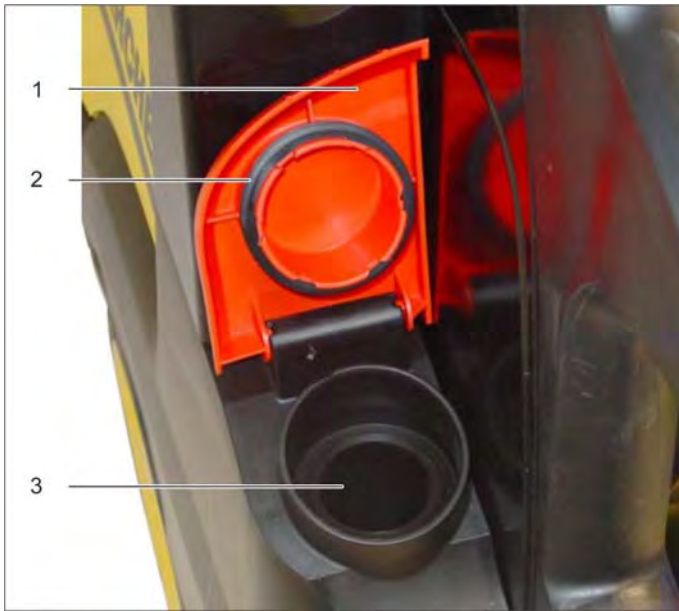

- 1 Closure fuel tank
- 2 Seal fuel tank closure
- 3 Filler neck

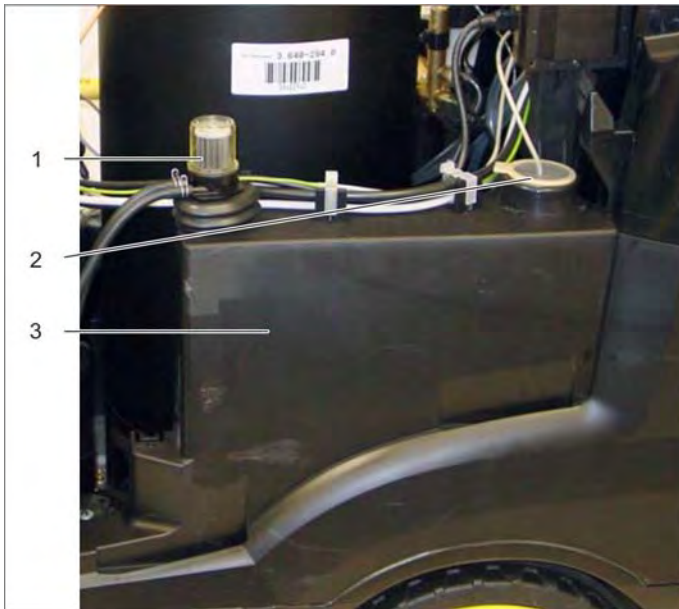

- 1 Fuel filter
- 2 Level sensor for fuel tank
- 3 Fuel tank

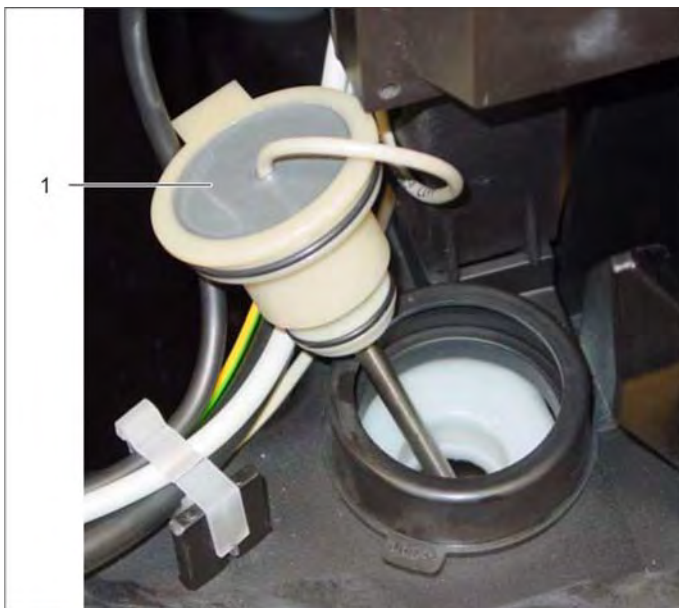

- 1 Level sensor for fuel tank

6.10 Liquid softener

6.10.1 Feed via tank (export variant)

The feed of the liquid softener takes place in accordance with the setting on the service switch. The setting is described under 6.8 "Service switch". The feed only takes place in the programme switch position "ECO" and "Warm water" at a set water temperature $\geq 50^{\circ}\text{C}$.

Bottle counter is increased by 1 after 2000 impulses.

The empty message takes place via the level sensor and is shown via an indicator lamp or display.

The burner operation is also possible without liquid softener. With hard water, however, malfunctions due to lime deposits must be expected.

Note

The dosing unit must not be switched off when using RM 111.

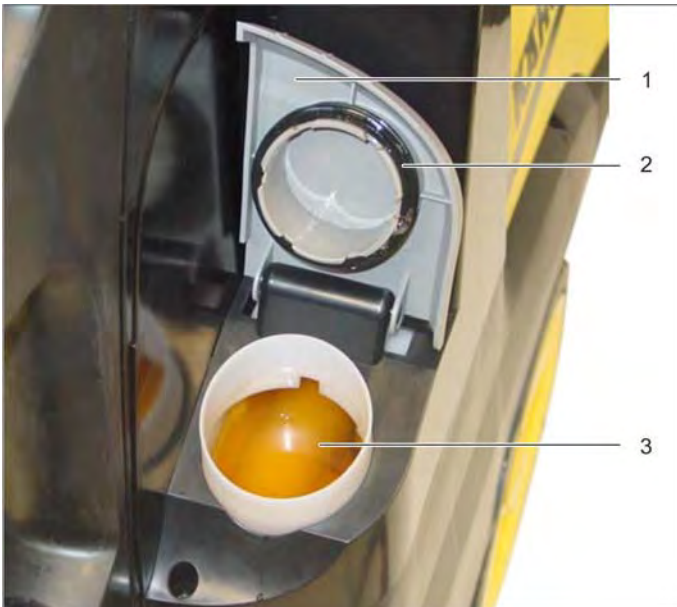

- 1 Lock
- 2 Washer
- 3 Liquid softener reservoir

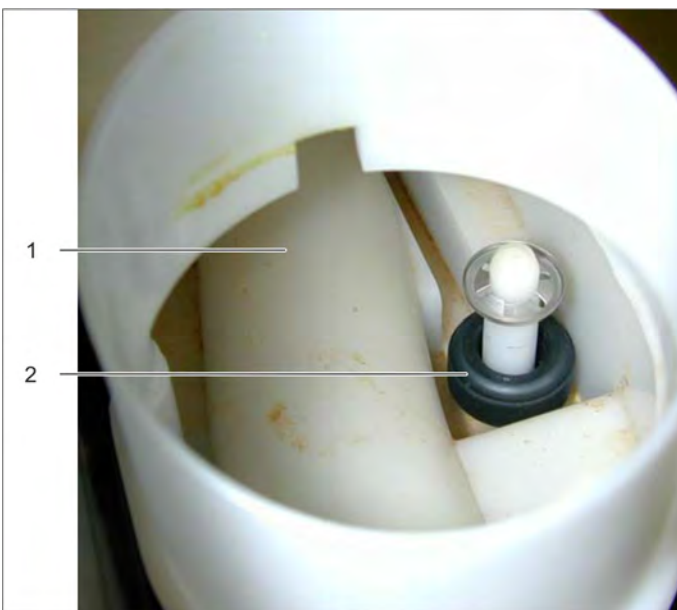

- 1 Liquid softener reservoir
- 2 Level sensor

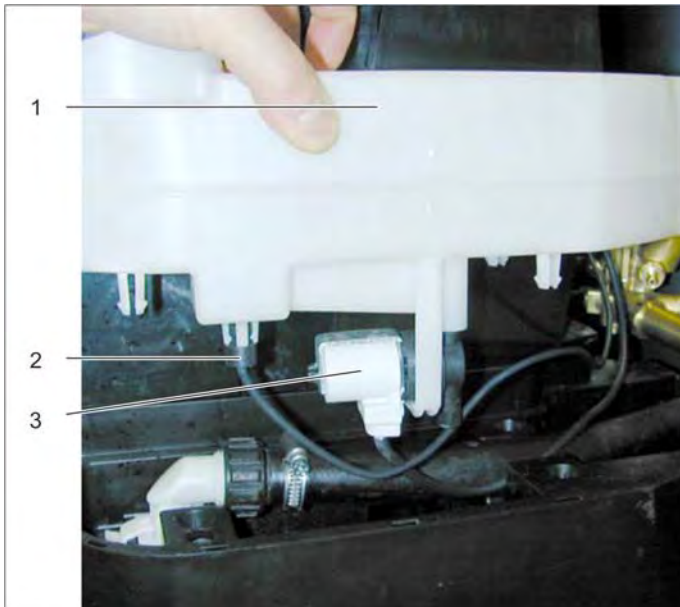

- 1 Liquid softener reservoir
- 2 Level sensor
- 3 Dosing valve

6.10.2 Feed via RFID (Europe variant)

The feed of the liquid softener takes place in accordance with the setting on the service switch. The setting is described under 6.8 "Service switch". The feed only takes place in the programme switch position "ECO" and "Warm water" at a set water temperature $\geq 50^{\circ}\text{C}$.

Bottle counter is increased by 1 after 2000 impulses.

The empty message takes place via the level sensor in the liquid softener tank or via the write-read electronics in combination with the tag on the bottle. The liquid softener bottle must be inserted within 5 operating hours, otherwise the burner switches off for the protection against calcification and a corresponding malfunction appears.

The burner operation is only enabled again by inserting a new original liquid softener bottle. A bottle that has already been empty but refilled will not be accepted.

The bottle works with an internal vacuum. If the bottle is damaged or a hole is drilled into the bottle, it will drain within a short period of time.

During burner operation with hard water without liquid softener malfunctions due to lime deposits must be expected.

Note

The dosing unit must not be switched off when using RM 111.

RM 111 was specially developed for the protection against black water. In order that the corrosion protection works optimally, it is also added in cold water operation. RFID recognises RM 111 over the day on the bottle and doses accordingly.

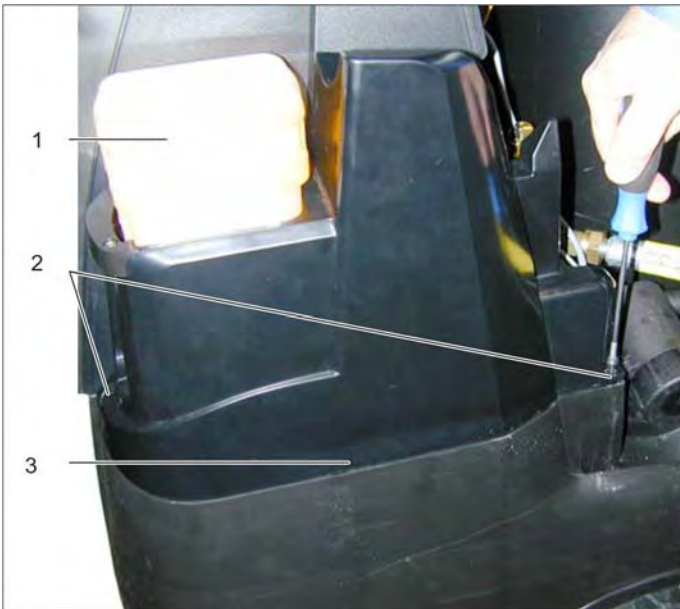

- 1 Liquid softener bottle
- 2 Screws
- 3 RFID - attachment

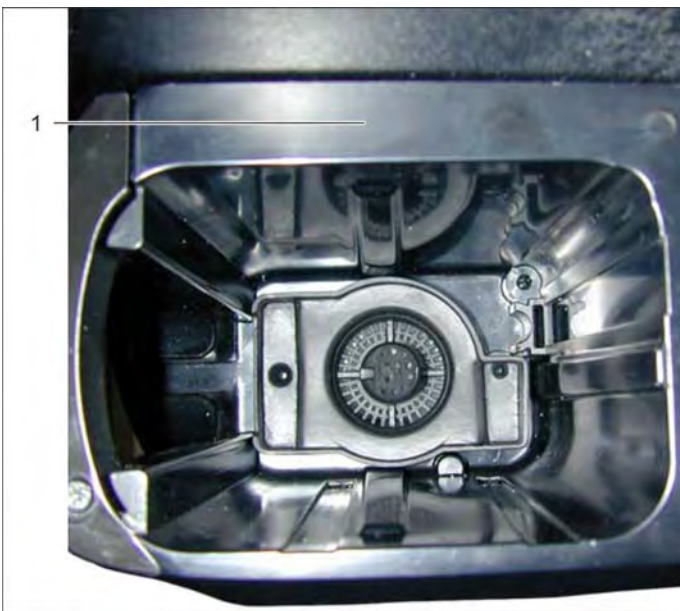

- 1 RFID - attachment
- 2 Bottle opener - insertion



- 1 Liquid softener bottle
- 2 Sealing

Note

The sealing is pierced upon inserting the bottle.

6.10.3 Functionality RFID

RFID (Radio Frequency Identification) stands for the identification by means of high frequency.

There is a transponder under the label on the softener bottle (microchip with antenna, also called tag).

The write-read electronics installed in the RFID attachment can read data from the tag and also write data to the tag.

The tag obtains the power supply from the high frequency field of the write-read electronics. The data transfer takes place by changes of the field intensity.

The write/read electronics query the type of detergent and saves the dosed units to the tag.

When the bottle is empty (after 2000 units) or when the level switch in the softener container reports empty, an after-running time of 5 hours is started. This after-running time is counted on the tag.

When the after-running time has elapsed or if the empty bottle is removed, the burner is switched off.

Once a bottle has been detected to be empty, it is blocked electronically and can no longer be used. Therefore, you must insert a new original softener bottle.

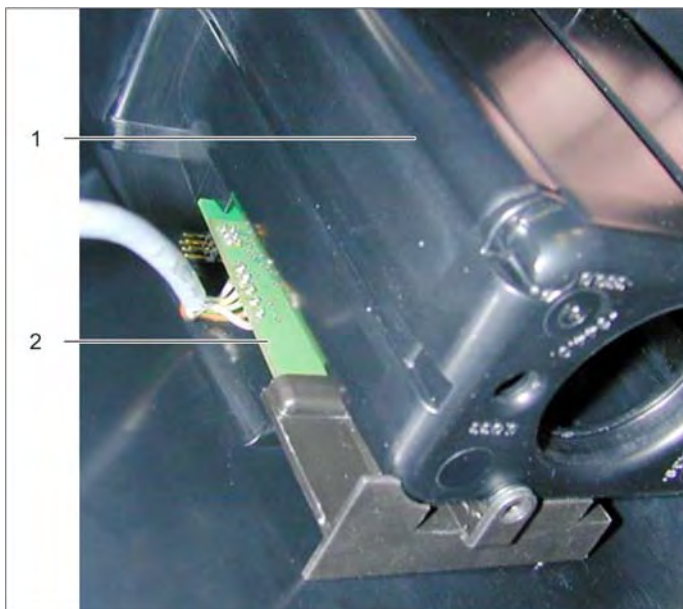

- 1 RFID - attachment
- 2 Write-read electronics

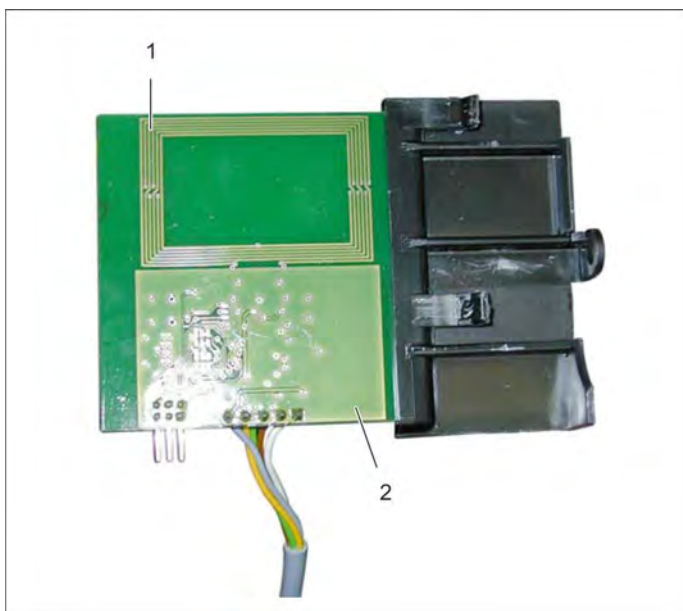

- 1 Antenna
- 2 Write-read electronics

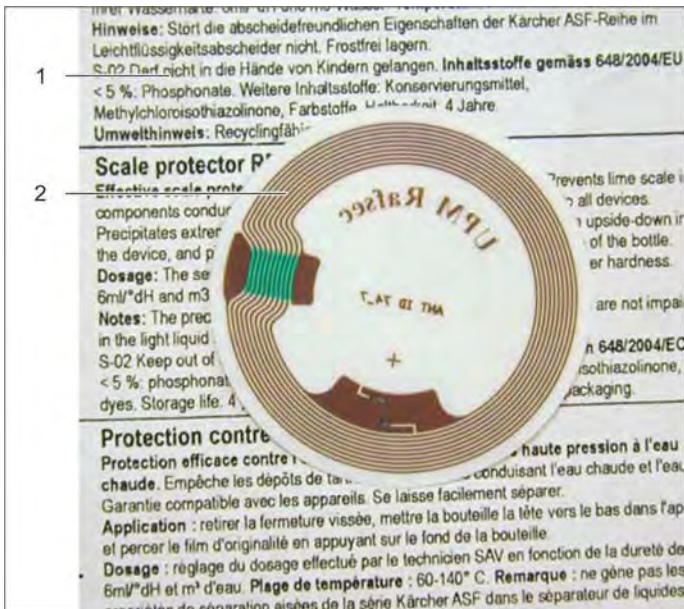

6.11 Swimmer tank

Float tank

The float container is integrated in the chassis. It is located on the right, under the liquid softener reservoir.

The swimmer reservoir supplies the pump evenly with water. It is also used to separate the water inlet and the pump and prevents detergent from entering the water supply line in case of damage.

Swimmer valve

Water flows into the float container through the opened float valve.

When the water level is rising, the float ball rises and closes the float valve.

The float valve is adjusted permanently and must not be readjusted.

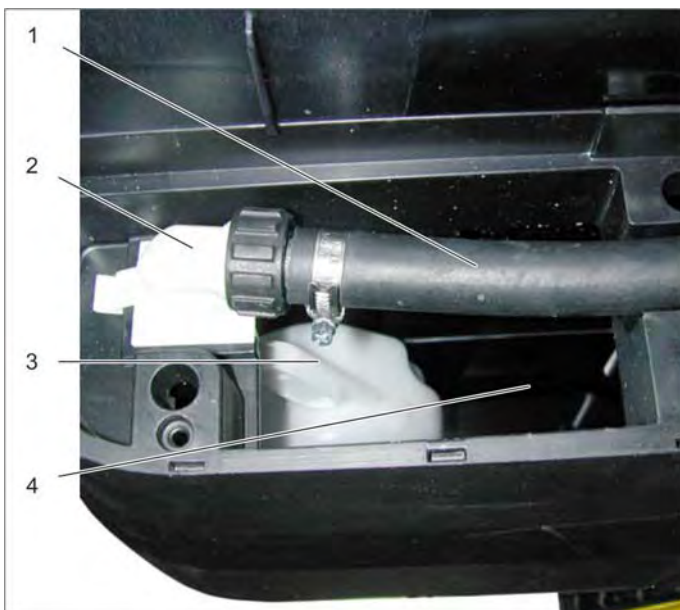

6.12 Detergent Tank

6.12.1 Detergent tank 1

Detergent tank 1 (volume 10l)

The detergent tank 1 is located in the rear part of the chassis.

Suction hose

The plug with the connection of the suction hose is located between the booster heater and the lower storage compartment or the hose reel.

Level sensor (option)

The level sensor contains a reed switch that is operated by means of a magnet in the float.

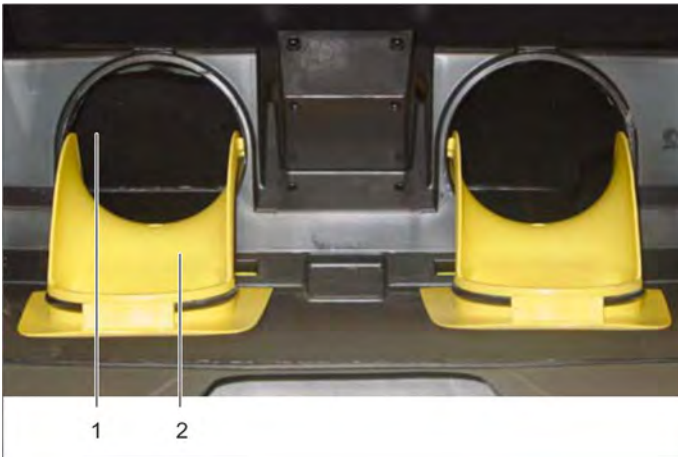

1 Detergent tank 1

2 Lock



1 Stopper

1 Level sensor (option)

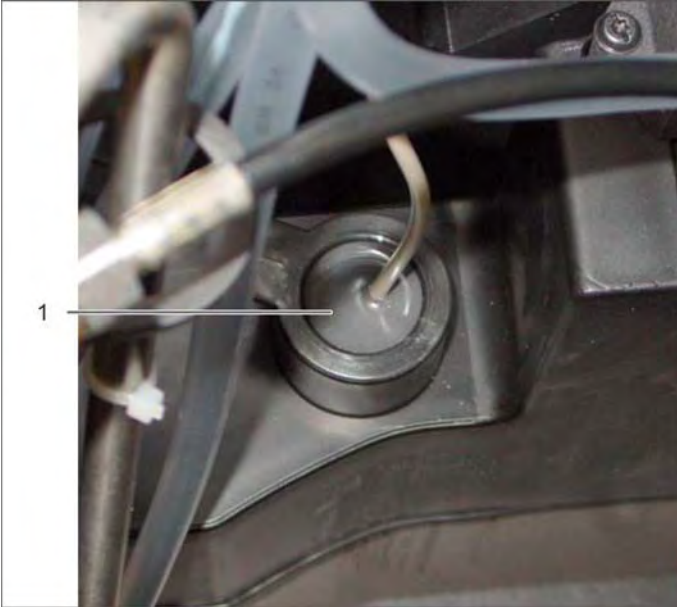

6.12.2 Detergent tank 2

Detergent tank 2 (volume 20l)

The detergent tank 2 is located in the right part of the chassis.

Suction hose

The plug with the connection of the suction hose is located above the right transport wheel. A detergent filter is attached at the end of the suction hose

Level sensor

The level sensor contains a reed switch that is operated by means of a magnet in the float.

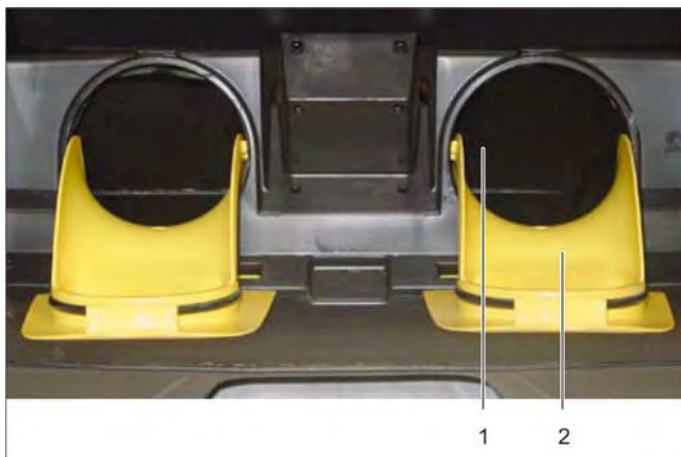

1 Detergent tank 2
2 Lock

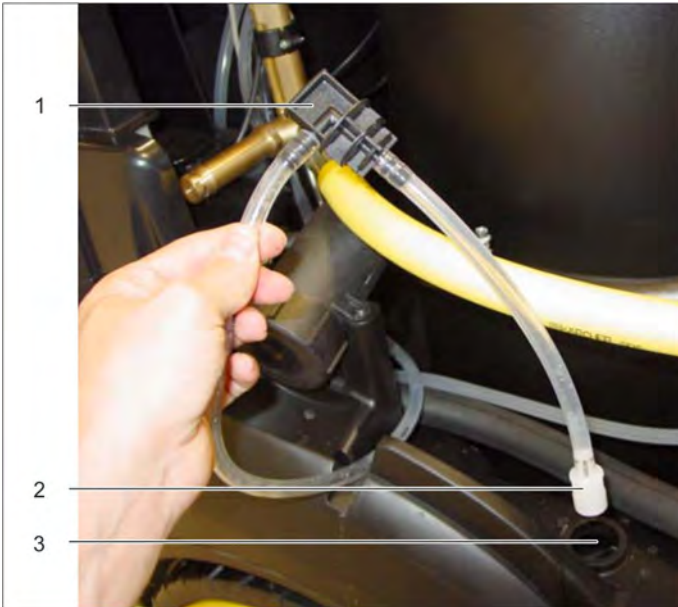

- 1 Stopper
- 2 Cleaning agent filter
- 3 Detergent tank 2

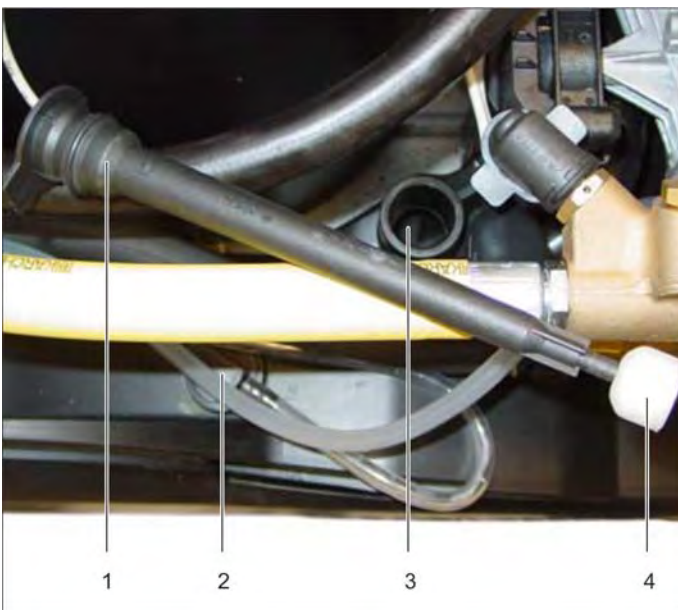

- 1 Level sensor (option)
- 2 Stopper
- 3 Detergent tank 2
- 4 Float

6.13 Detergent dosing valve

Detergent dosing valve with automatic clear rinsing in zero position



- 1 Water
- 2 Detergent tank 1
- 3 Detergent tank 2
- 4 Pump

6.14 Motor (air-cooled)

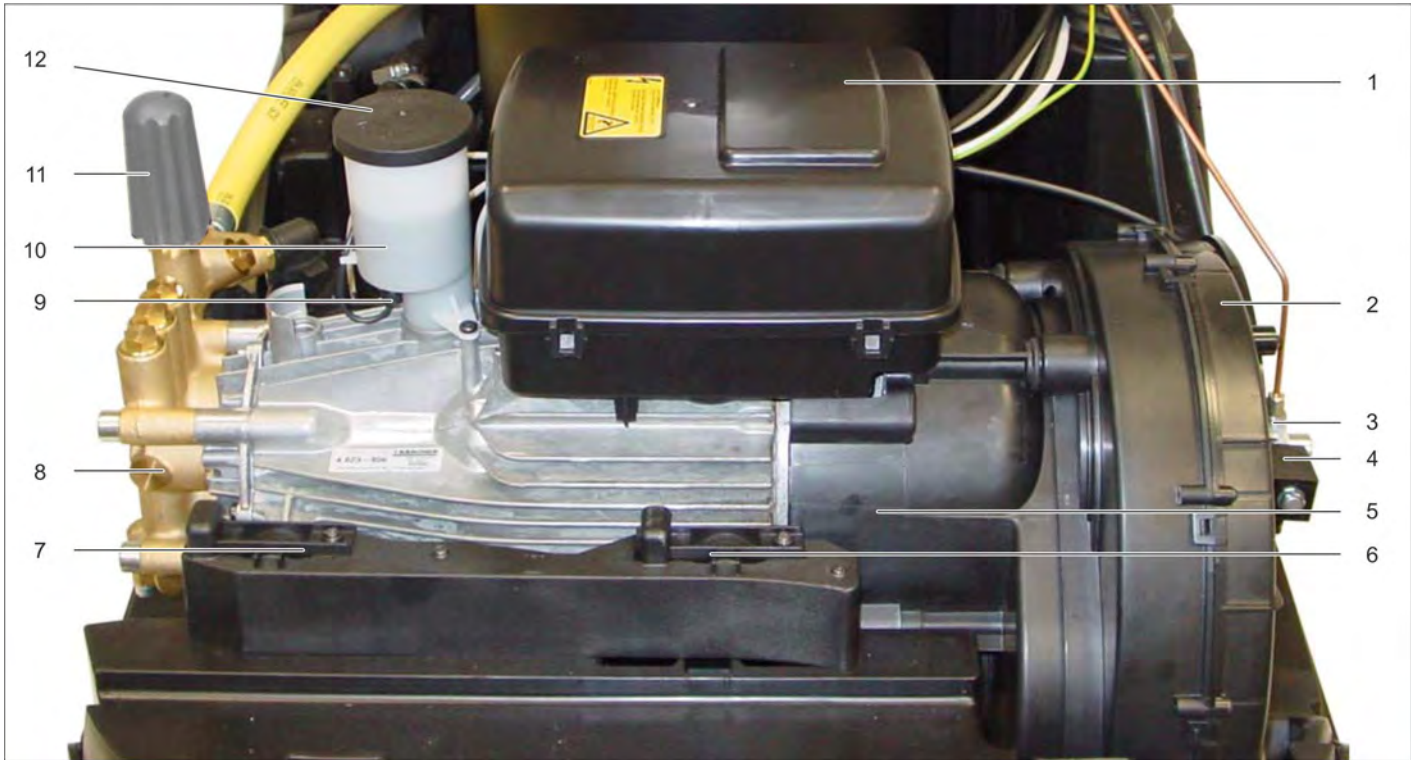

- | | |
|-------------------------|---|
| 1 Electronics system | 8 Pump head |
| 2 Burner blower | 9 Oil level sensor |
| 3 Fuel pump | 10 Oil fill container |
| 4 Solenoid valve | 11 Handle, pressure and volume regulation |
| 5 Blower, motor cooling | 12 Cover |
| 6 Engine mount, left | |
| 7 Engine mount, right | |

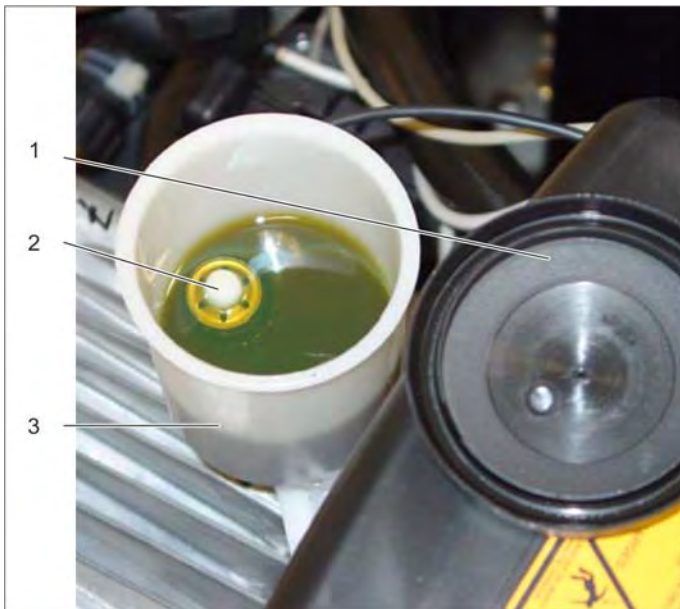

- | |
|----------------------|
| 1 Cover |
| 2 Oil level sensor |
| 3 Oil fill container |

Oil drain screw

The oil drain screw is located on the bottom of the pump casing.

6.14.1 Motor (air-cooled)

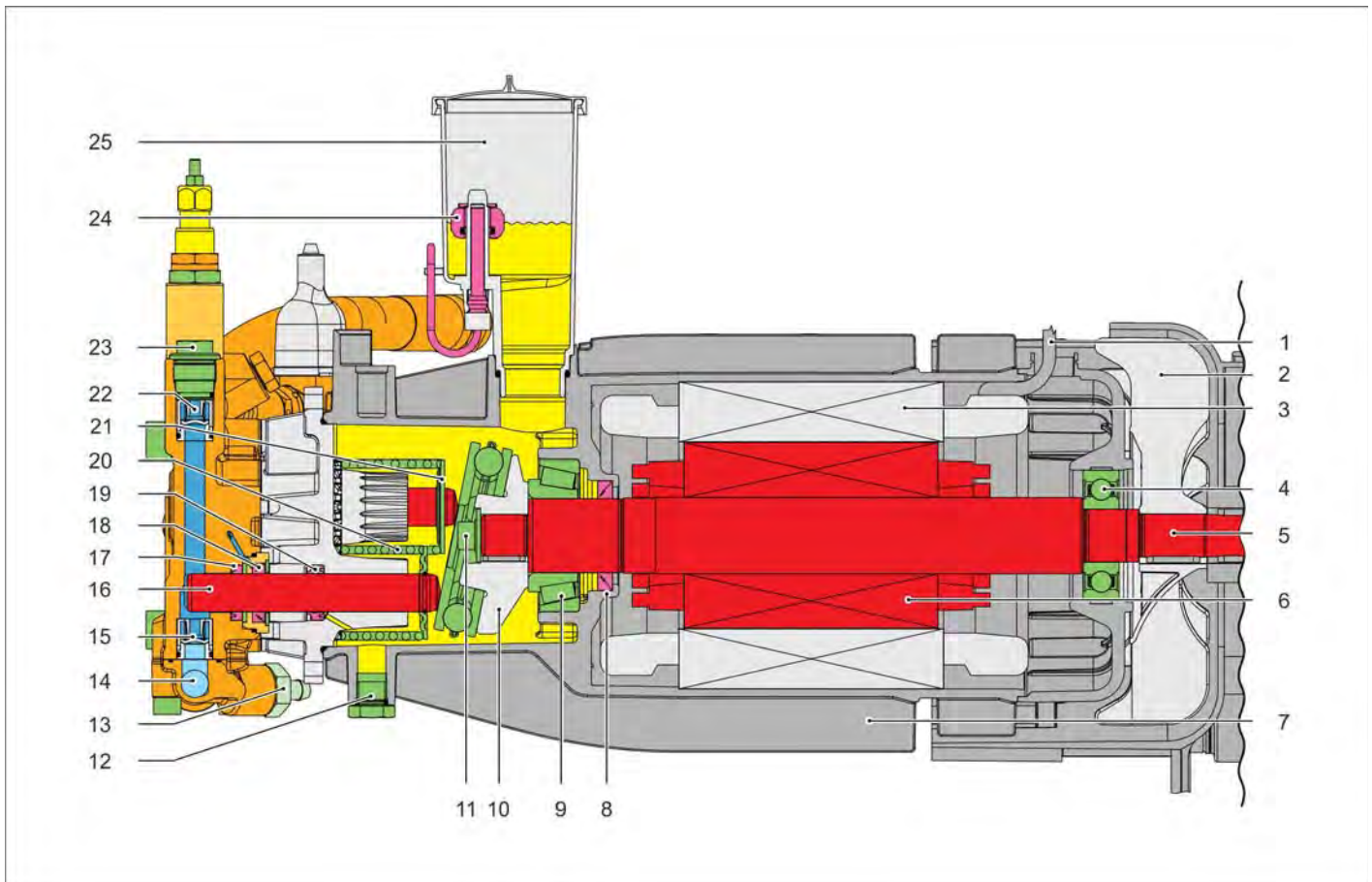

- | | |
|--|--------------------------------------|
| 1 Connecting cable, motor | 14 Suction side |
| 2 Fan wheel | 15 Suction valve |
| 3 Stator | 16 Piston |
| 4 Motor bearing, rear (B bearing) | 17 High pressure seal |
| 5 Motor shaft | 18 Low pressure seal |
| 6 Rotor | 19 Oil seal |
| 7 Casing | 20 Piston spring |
| 8 Shaft seal ring | 21 Retaining plate for piston spring |
| 9 Motor bearing, front (A bearing) | 22 Pressure valve |
| 10 Swash plate with axial ball bearing | 23 Valve screw |
| 11 Screw | 24 Oil level sensor |
| 12 Oil drain screw | 25 Oil fill container |
| 13 Detergent suck in | |

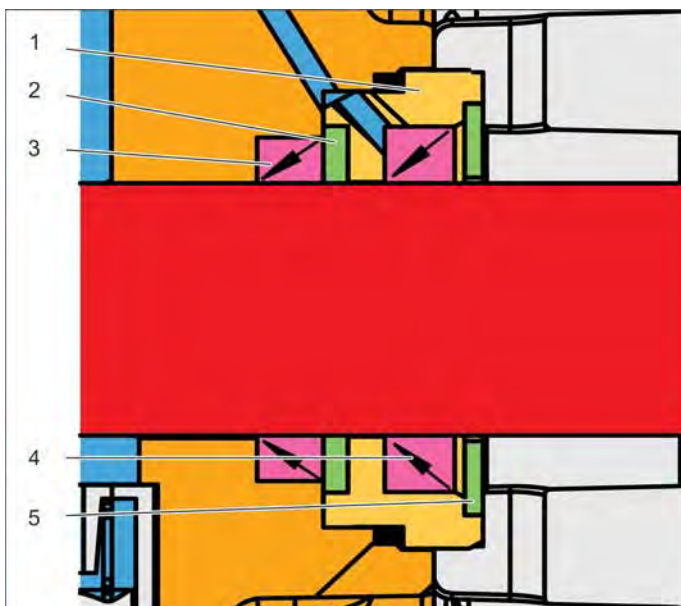

- | |
|----------------------|
| 1 Bushing |
| 2 Washer, plastic |
| 3 High pressure seal |
| 4 Low pressure seal |
| 5 Washer, brass |

6.15 Electrical box, air-cooled motor

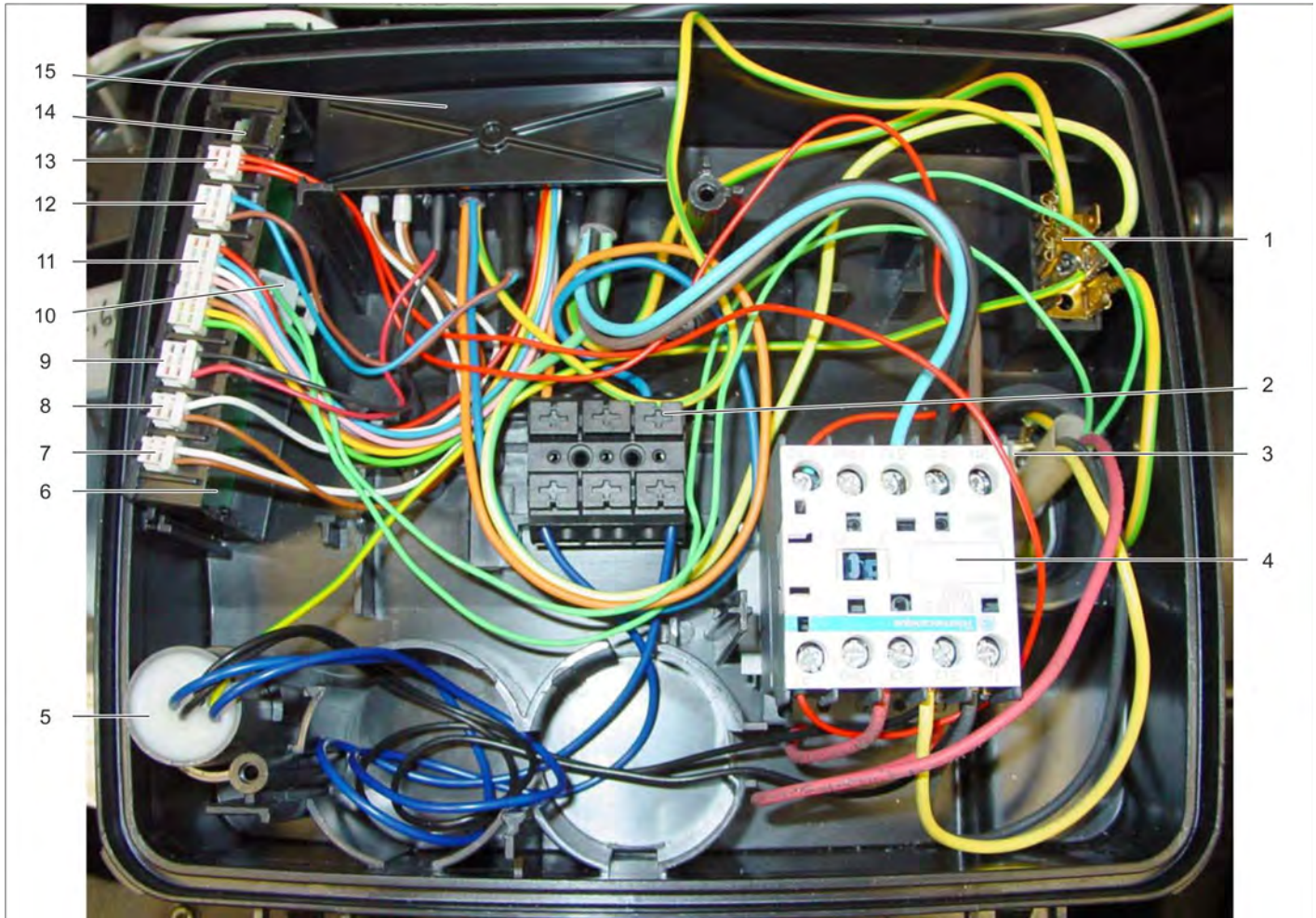

- | | | | | |
|---|--------------------------------|----|----|---|
| 1 | Ground point | | 10 | Connection of coiling protection contact |
| 2 | Terminal strip | | 11 | Connection printed circuit board, operating panel |
| 3 | Connection to earth, motor | | 12 | Connection fuel solenoid valve |
| 4 | Engine contactor | K1 | 13 | Connection motor protection |
| 5 | Anti-interference filter | | 14 | Connection is not used |
| 6 | Board, motor distributor | | 15 | Cable comb |
| 7 | Connection pressure switch ON | | | |
| 8 | Connection pressure switch OFF | | | |
| 9 | Oil level sensor connection | | | |

6.16 Engine (water-cooled)

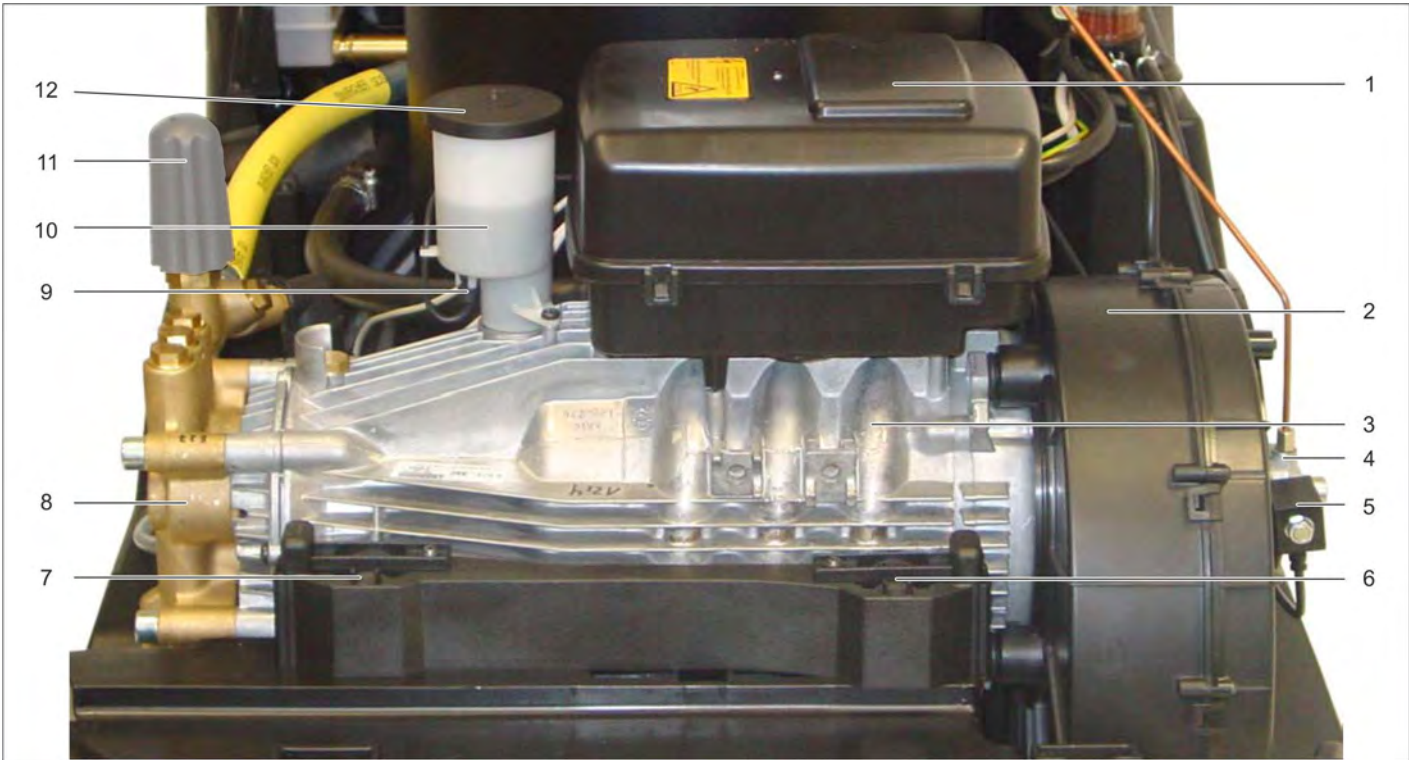

- 1 Electronics system
- 2 Burner blower
- 3 Cooling coil
- 4 Fuel pump
- 5 Solenoid valve
- 6 Engine mount, left
- 7 Engine mount, right

- 8 Pump head
- 9 Oil level sensor
- 10 Oil fill container
- 11 Handle, pressure and volume regulation
- 12 Cover

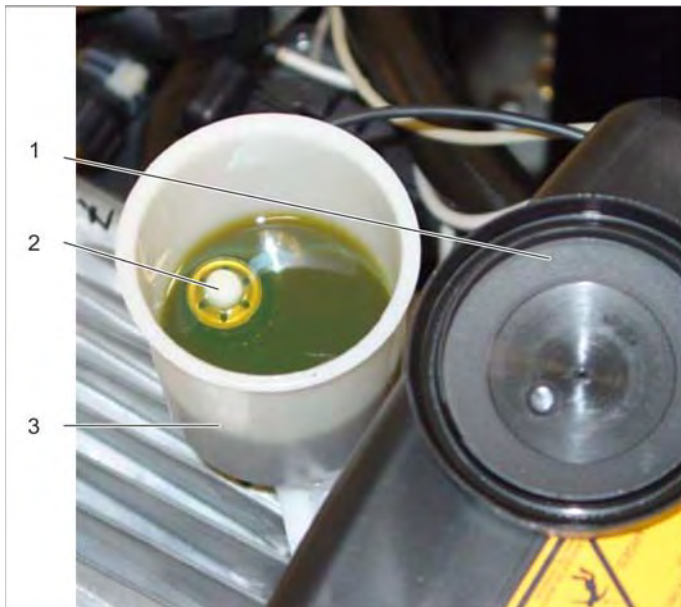

Oil drain screw

The oil drain screw is located on the bottom of the pump casing.

- 1 Cover
- 2 Oil level sensor
- 3 Oil fill container

6.16.1 Engine (water-cooled)

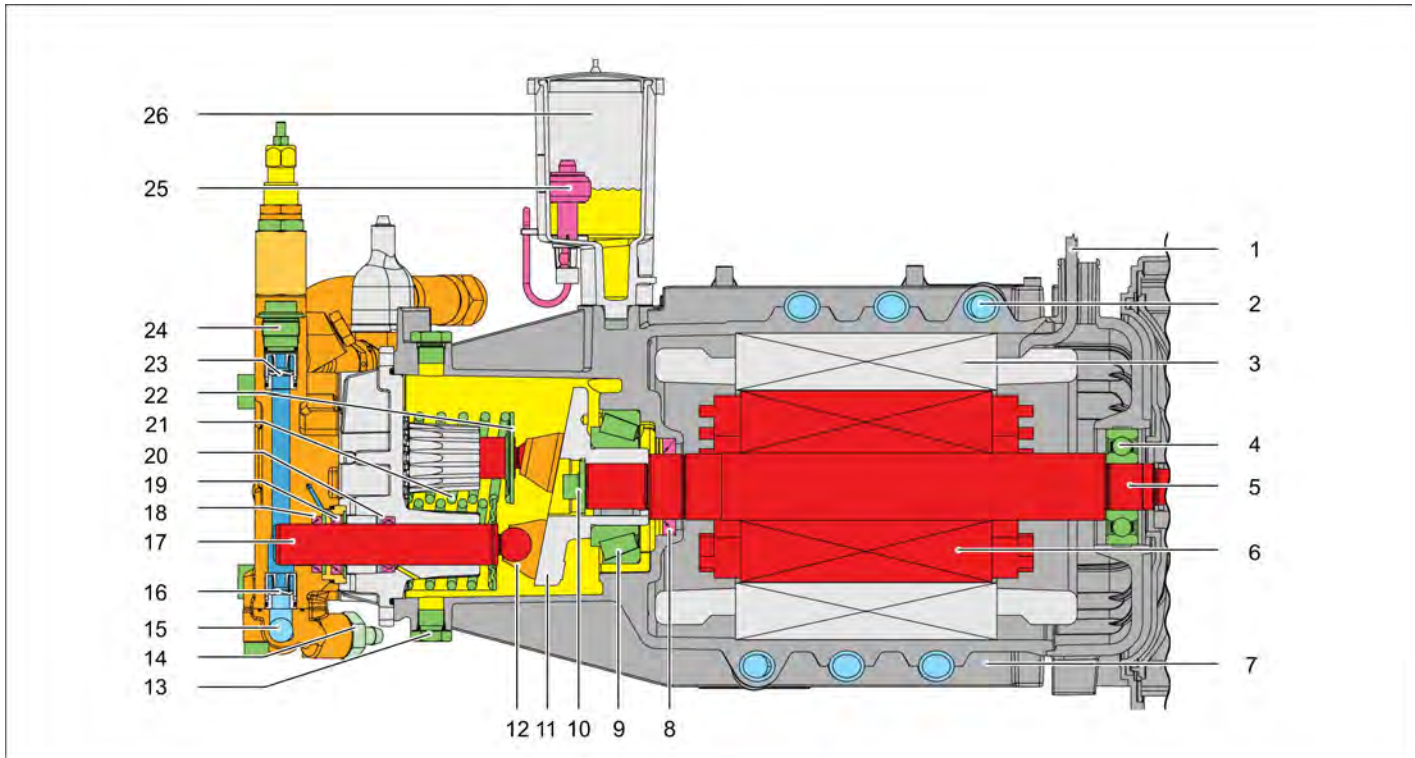

- | | |
|------------------------------------|---|
| 1 Connecting cable, motor | 15 Suction side |
| 2 Cooling coil | 16 Suction valve (green with HDS 13/20) |
| 3 Stator | 17 Piston |
| 4 Motor bearing, rear (B bearing) | 18 High pressure seal |
| 5 Motor shaft | 19 Low pressure seal |
| 6 Rotor | 20 Oil seal |
| 7 Casing | 21 Piston spring |
| 8 Shaft seal ring | 22 Retaining plate for piston spring |
| 9 Motor bearing, front (A bearing) | 23 Pressure valve |
| 10 Screw | 24 Valve screw |
| 11 Swash plate | 25 Oil level sensor |
| 12 Slide shoe | 26 Oil fill container |
| 13 Oil drain screw | |
| 14 Detergent suck in | |

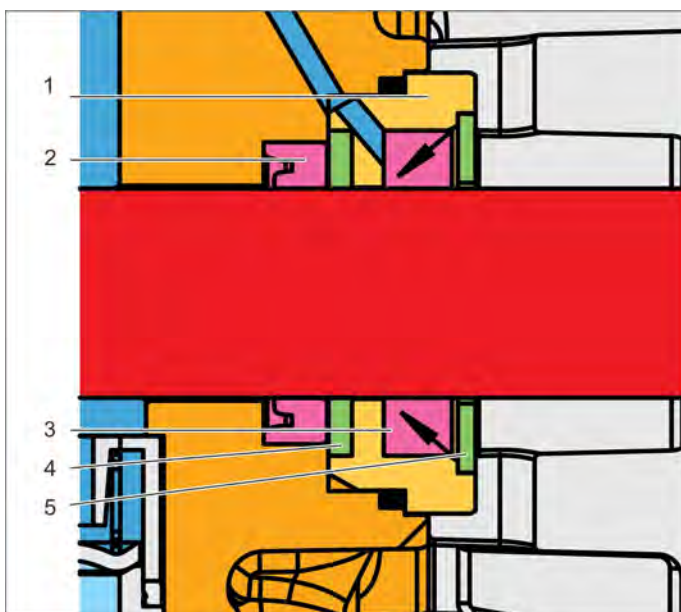

- | |
|----------------------|
| 1 Bushing |
| 2 High pressure seal |
| 3 Low pressure seal |
| 4 Washer, plastic |
| 5 Washer, brass |

6.16.2 Electrical box, water-cooled engine

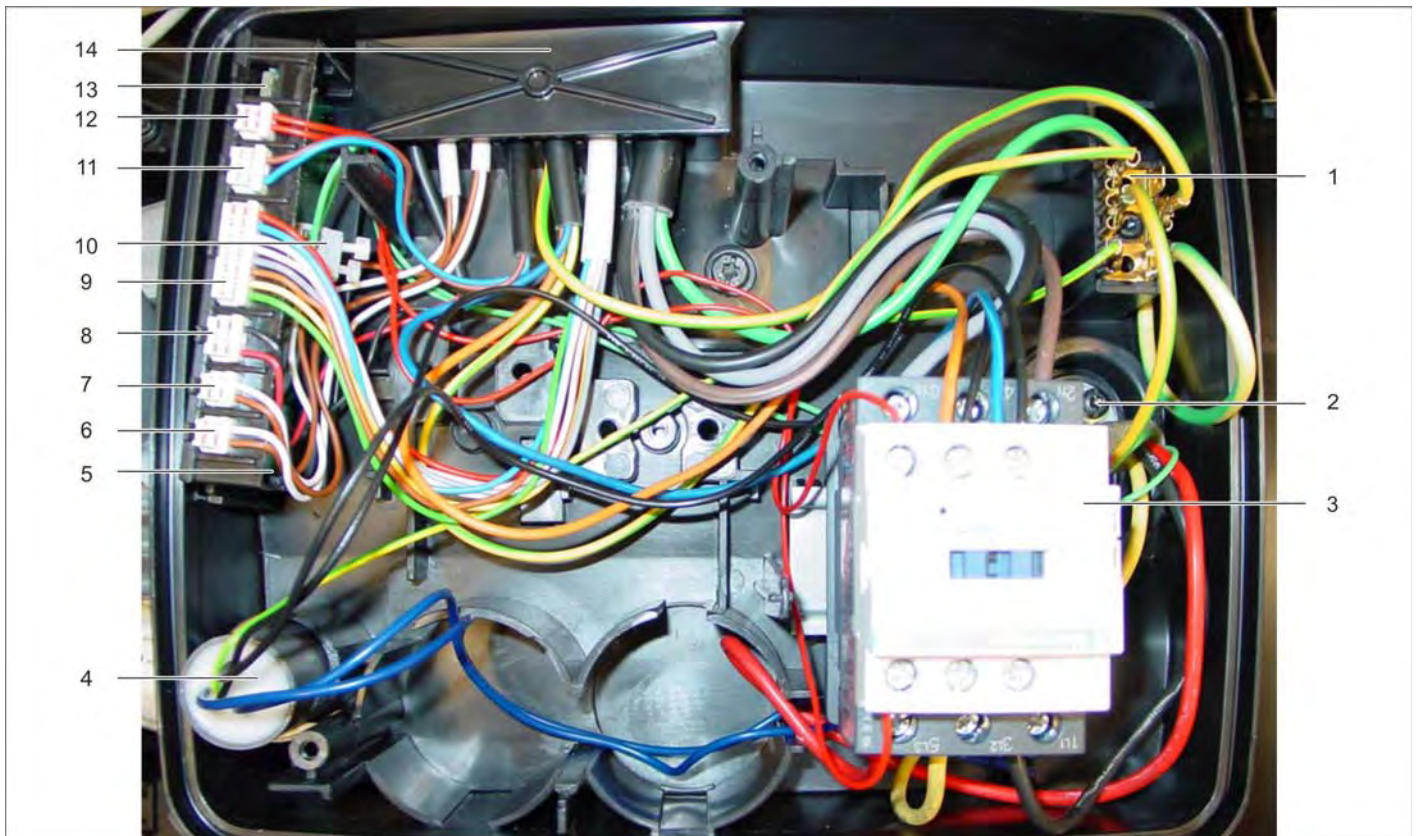

- | | | | |
|---|--------------------------------|----|---|
| 1 | Ground point | 8 | Oil level sensor connection |
| 2 | Connection to earth, motor | 9 | Connection printed circuit board, operating panel |
| 3 | Engine contactor | 10 | Connection of coiling protection contact |
| 4 | Anti-interference filter | 11 | Connection fuel solenoid valve |
| 5 | Board motor distributor | 12 | Connection motor protection |
| 6 | Connection pressure switch ON | 13 | Connection is not used |
| 7 | Connection pressure switch OFF | 14 | Cable comb |

6.17 Pump

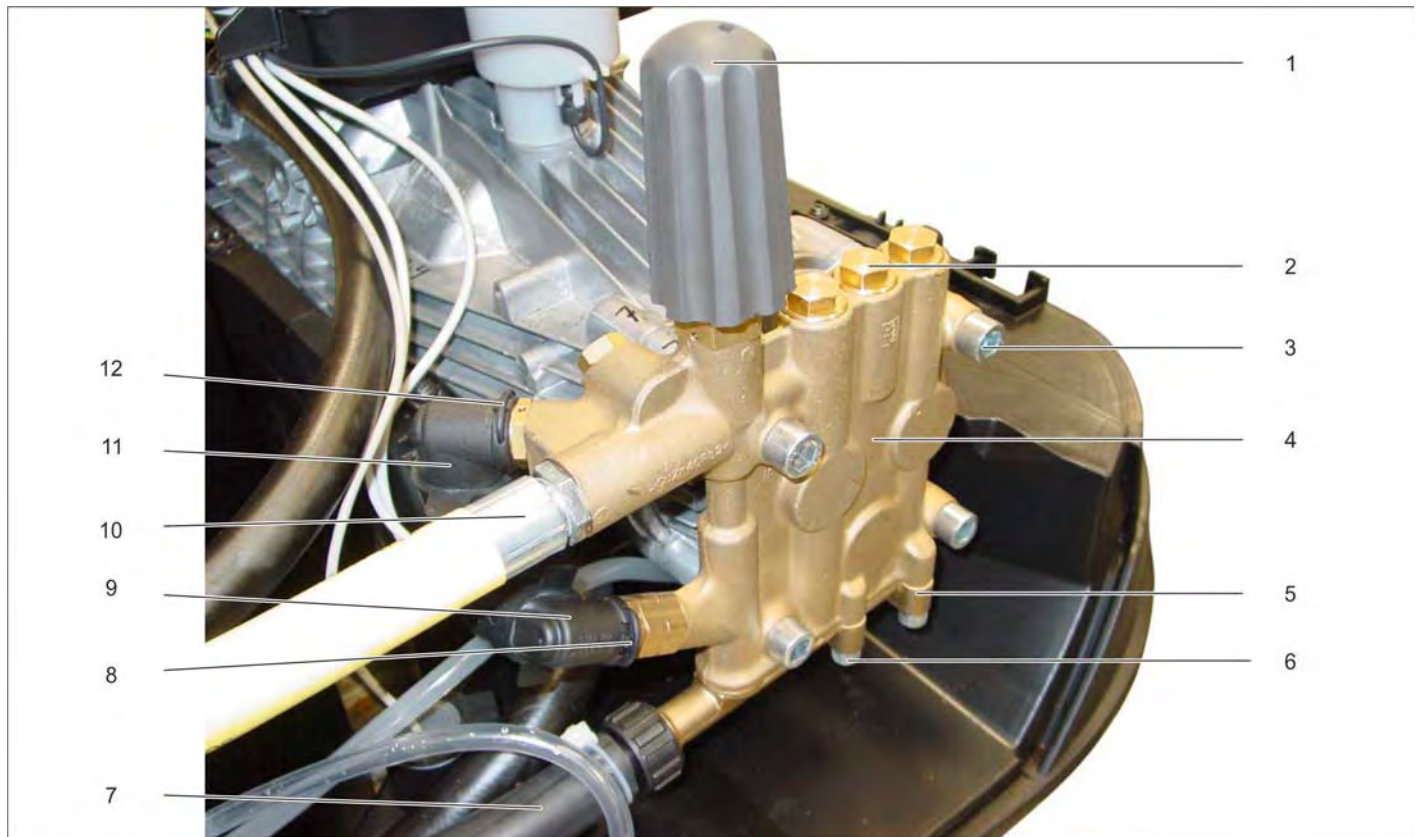

- 1 Handle, pressure and volume regulation
- 2 Screwed sealing plug
- 3 Screws pump head
- 4 Pump head
- 5 Suction jumper
- 6 Screwed sealing plug
- 7 Water pipes
- 8 Safety bracket, pressure switch OFF
- 9 Pressure switch OFF
- 10 SDS hose to the safety block
- 11 Pressure switch ON
- 12 Safety bracket, pressure switch ON

6.17.1 Revised version with filter before the pump

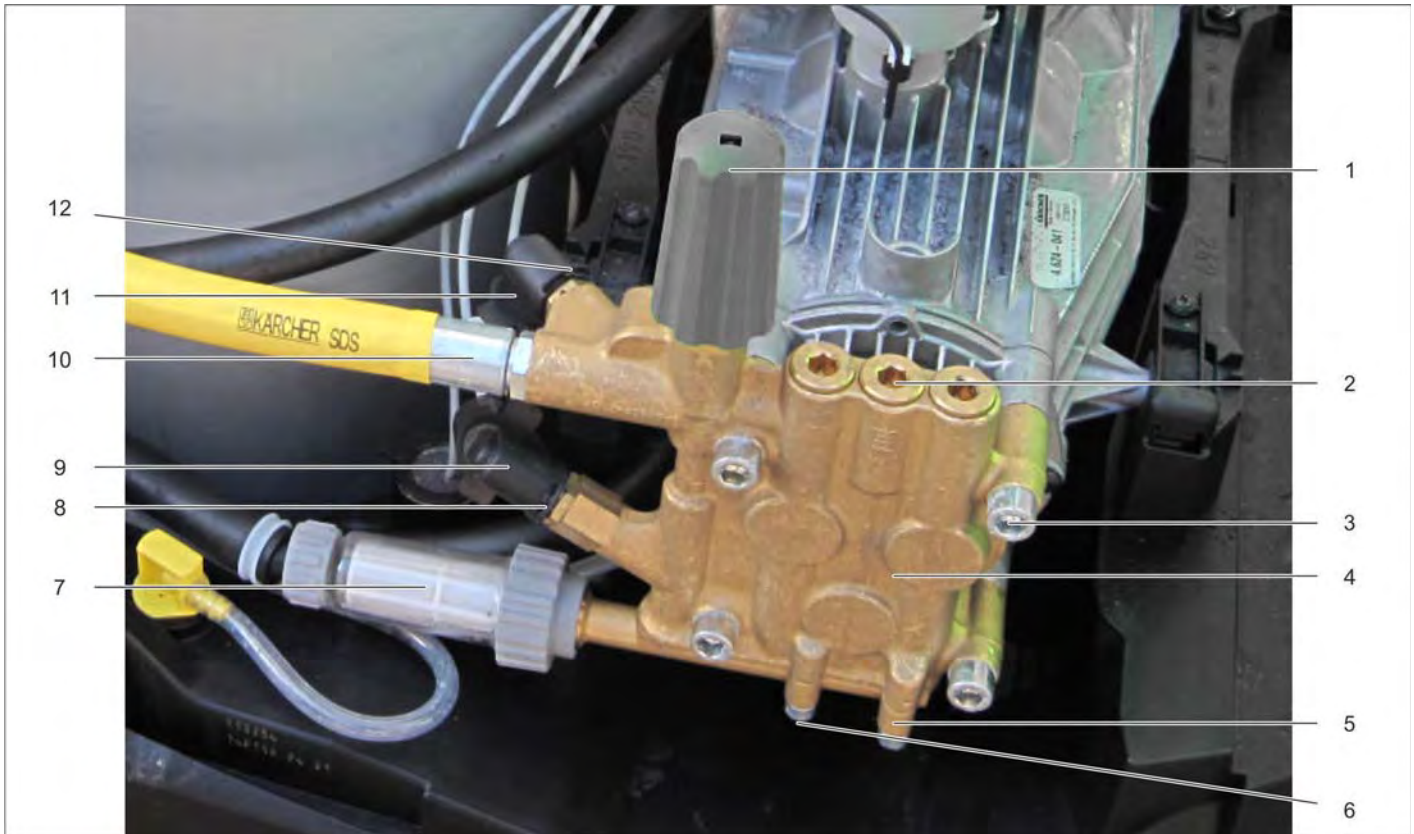

- 1 Handle, pressure and volume regulation
- 2 Screwed sealing plug
- 3 Screws pump head
- 4 Pump head
- 5 Suction jumper
- 6 Screwed sealing plug

- 7 Filter
- 8 Safety bracket, pressure switch OFF
- 9 Pressure switch OFF
- 10 SDS hose to the safety block
- 11 Pressure switch ON
- 12 Safety bracket, pressure switch ON

6.18 Safety block

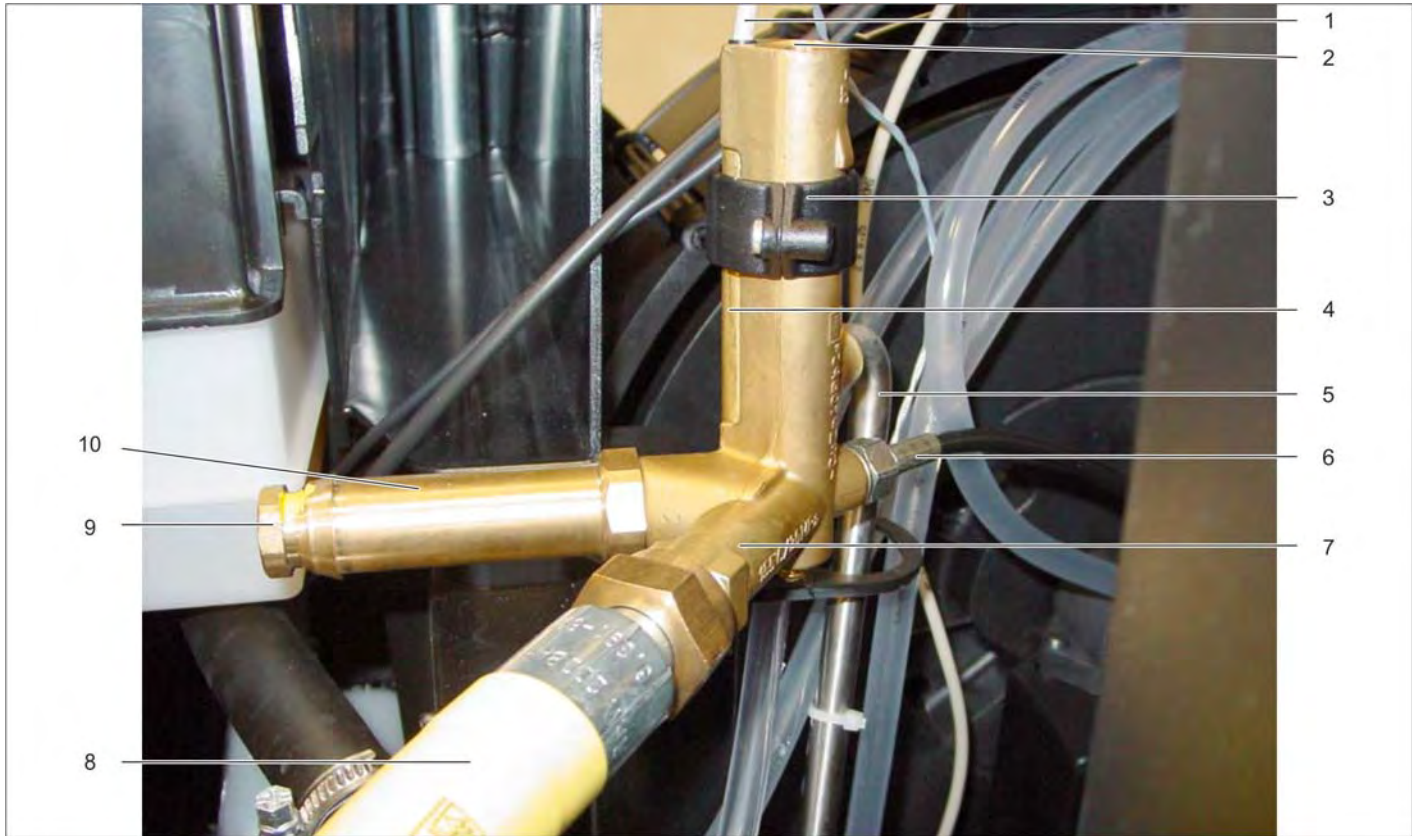

- 1 Connecting cable, reed switch
- 2 Screwed sealing plug
- 3 Clamping bracket
- 4 Reed switch
- 5 High pressure pipe to the on-demand heater
- 6 Connection hose pressure gauge

- 7 Safety block
- 8 SDS hose
- 9 Adjustment screw, safety valve
- 10 Valve ball

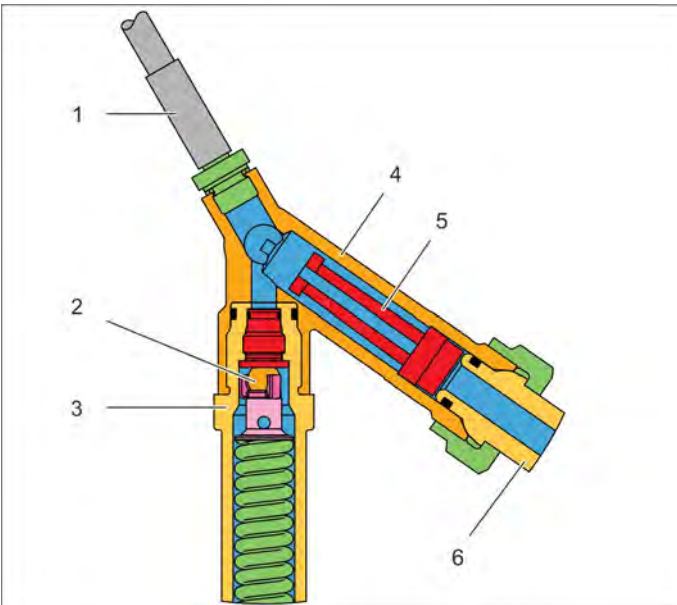

- 1 Connection hose pressure gauge
- 2 Valve ball
- 3 Safety valve
- 4 Safety block
- 5 Sieve
- 6 SDS hose

6.19 Safety block (water shortage safeguard old)

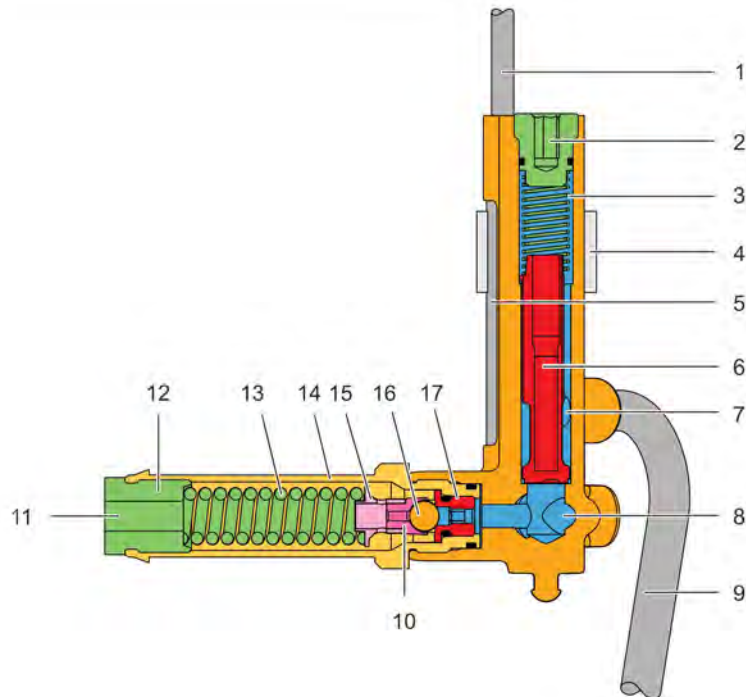

- | | | | |
|---|--|----|----------------------|
| 1 | Connecting cable, reed switch | 10 | Mould part |
| 2 | Screwed sealing plug | 11 | Water outlet |
| 3 | Spring | 12 | Adjusting screw |
| 4 | Clamping bracket | 13 | Spring, safety valve |
| 5 | Reed switch | 14 | Casing |
| 6 | Magnetic piston | 15 | Spring plate |
| 7 | Holes | 16 | Valve ball |
| 8 | Water inlet, from the high pressure pump | 17 | Valve seat |
| 9 | High pressure pipe to the on-demand heater | | |

6.19.1 Water shortage safeguard as cartridge

Note

The cartridge replaces the previous design with piston and spring.

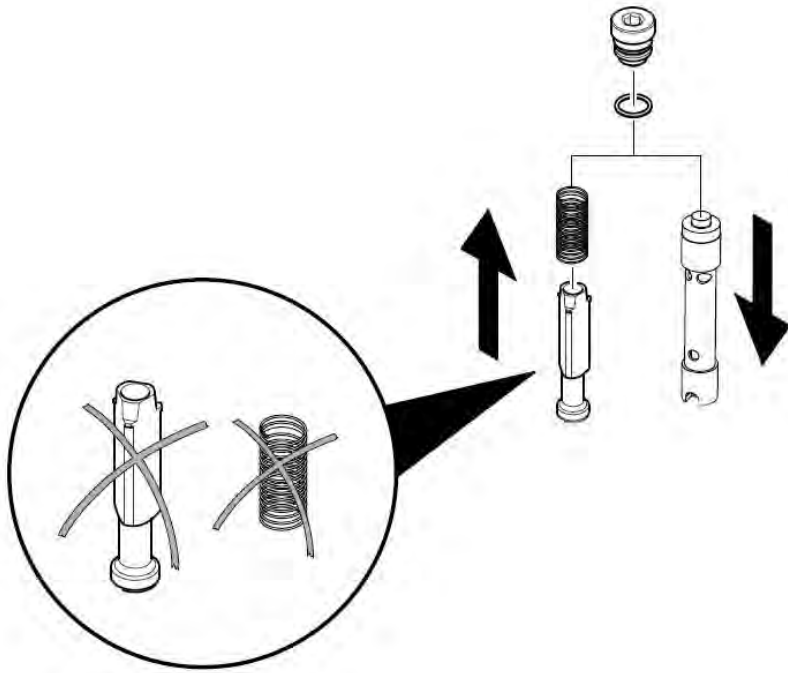

6.19.2 Safety block (water shortage safeguard new)

Note

Recommended installation direction: The lower drilled hole of the cartridge points towards the high-pressure pipe to the booster heater.

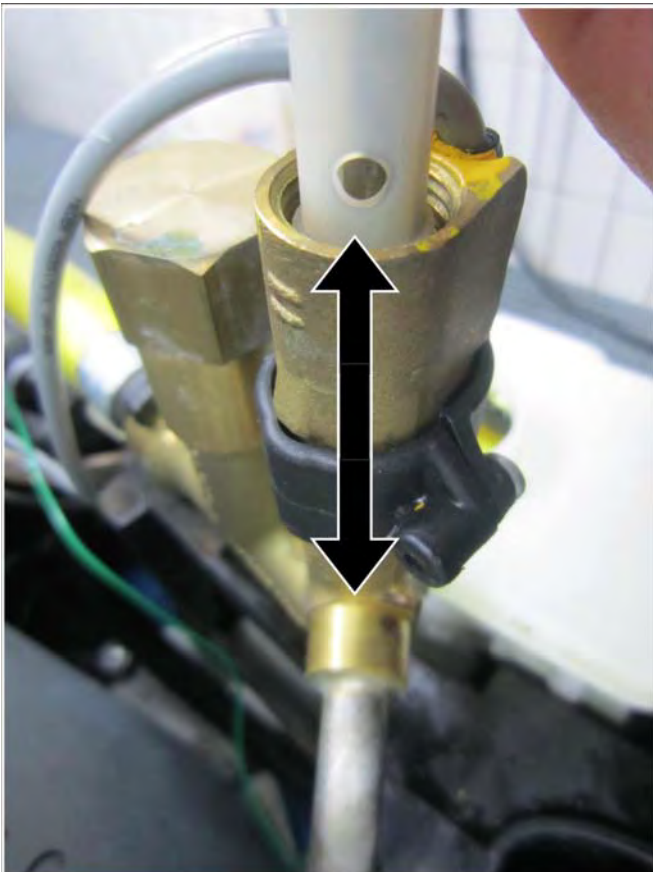

6.19.3 Function water shortage safeguard and dry-run protection

The lack of water fuse prevents the burner from switching on in case of missing or insufficient water volume and thus protects the on-demand heater from overheating.

With an opened gun and a sufficient water flow the solenoid is lifted against the force of gravity in the cartridge.

The solenoid piston closes the contact of the reed switch.

This opens the fuel solenoid valve and the burner ignites.

The sieve in the water supply of the safety block prevents the contamination of the lack of water fuse.

The lack of water fuse is a safety component and therefore its locking screw is sealed.

The information regarding insufficient water volumes is sent directly to the control PCB.

There, this message is evaluated as

- lack of water fuse (shut-off of burner, see above) and as
- Dry-run protection for the pump (switch-off device).

The lack of water fuse functions immediately.

It switches the burner off immediately in case of insufficient water volume and back on after the water level has been replenished.

The dry run protection is initiated when the lack of water fuse signals insufficient water volume for 2 minutes.

The appliance shuts off with a fault message and locks up.

Only by switching the device off and back on via the main switch, it can be taken into operation again.

As the dry-run protection damages the pump in the long run, there must always be a sufficient water supply.

6.19.4 Function of safety valve

The safety valve guides the entire flow rate of the pump to the float container if the pressure switch or the overflow valve is defective and thus protects the device and accessories from inadmissibly high overpressure.

If the gun is open, the safety valve is closed and the entire flow volume of the pump is transferred to the gun at operating pressure.

If the pressure in the high pressure system rises by approx. 20 bar above the permissible operating pressure, the valve ball is lifted off the valve seat and part of the flow volume flows into the swimmer reservoir.

The opening pressure of the safety valve is adjusted with the adjustment screw.

Rotation to the right increases the opening pressure, rotation to the left decreases the opening pressure.

The safety valve is a safety component and therefore its adjustment screw is sealed.

Note

The safety valve is adjusted via the pressure increase in the system with the burner turned on, so that it limits the pressure increase to the max. permissible value (see Specifications) with the gun closed.

Then seal the settings.

6.20 Burner blower with fuel pump

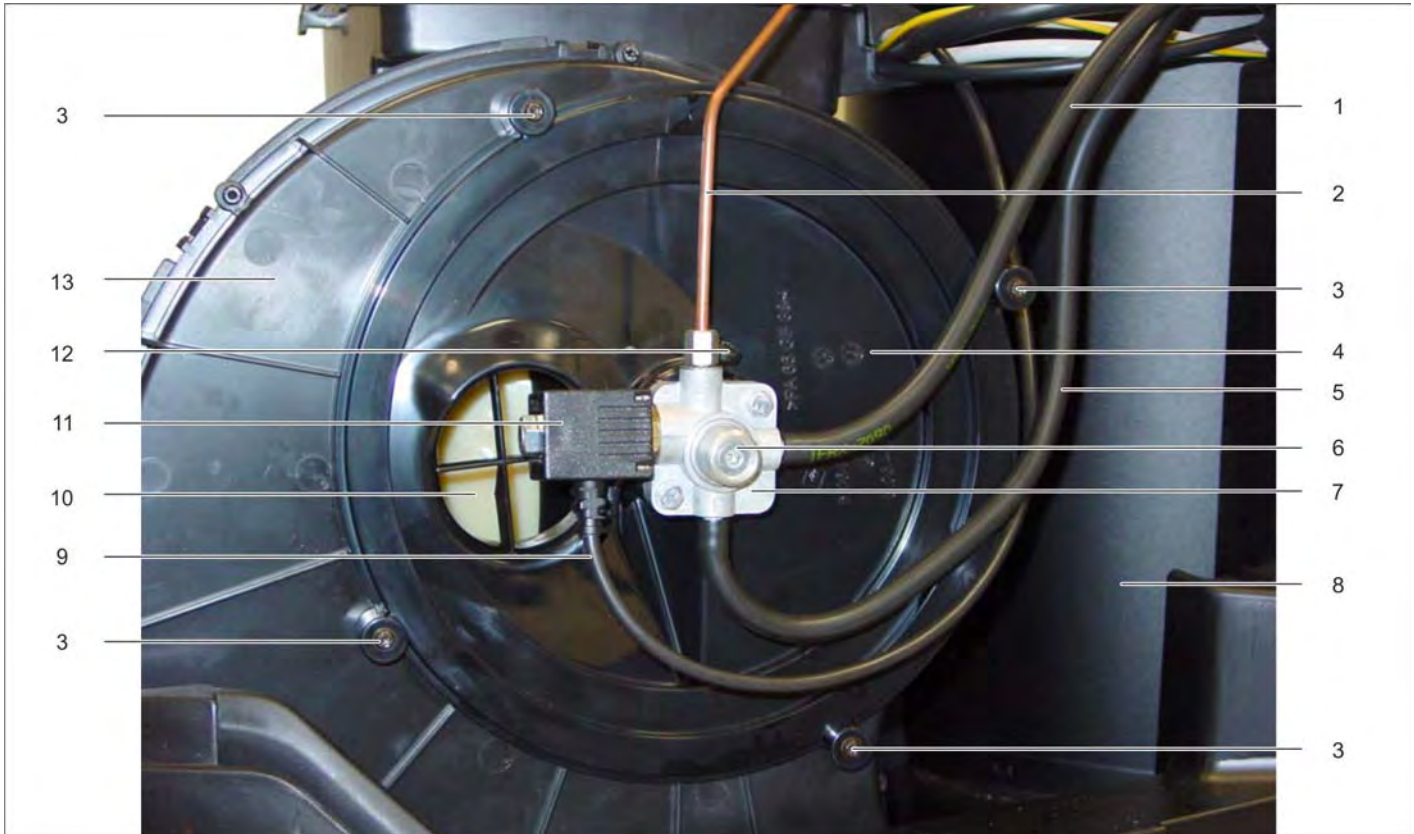

- 1 Return
- 2 Pressure line
- 3 Screw
- 4 Blower lid
- 5 Fuel line
- 6 Setting fuel pressure
- 7 Fuel pump
- 8 Continuous heater
- 9 Connecting cable solenoid valve
- 10 Suction opening, burner blower
- 11 Solenoid valve for fuel
- 12 Fastening screw fuel pump
- 13 Blower lid



- 1 Rubber collar
- 2 Lock
- 3 Air door, air volume adjustment
- 4 Stop screw
- 5 Burner blower

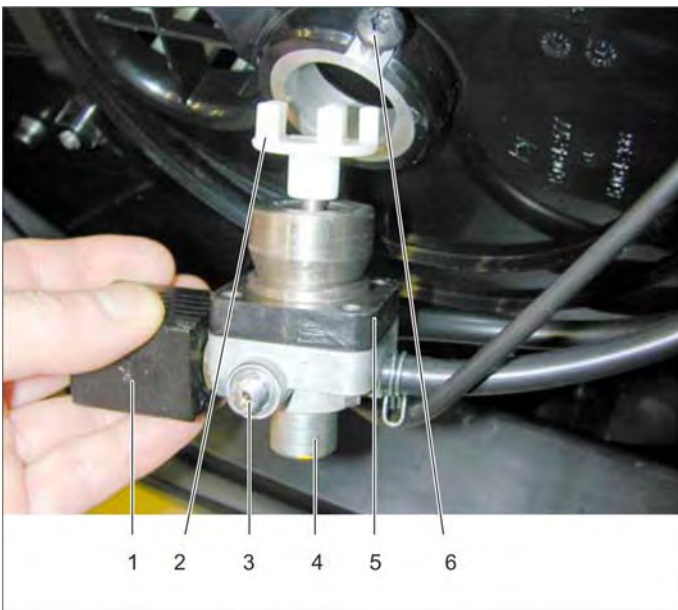

- 1 Solenoid valve
- 2 Coupling unit
- 3 Connection pressure line
- 4 Setting fuel pressure
- 5 Fuel pump
- 6 Fastening screw

Uninstall fuel pump

- Detach pressure line.
- Unscrew locking screws.
- Remove the fuel pump.

Fuel pump

The fuel pump is connected directly to the motor shaft via the coupling piece and the blower wheel. It also feeds fuel from the tank and back via the return during cold water operation. This lubricates the toothed wheel pump.

During warm water operation, the installed solenoid valve and part of the fuel reaches the burner through the fuel nozzle and is ignited there.

The fuel pressure is adjusted via the central setting screw. During dry runs, the fuel pump will block.

The coupling piece serves as a nominal breaking point.

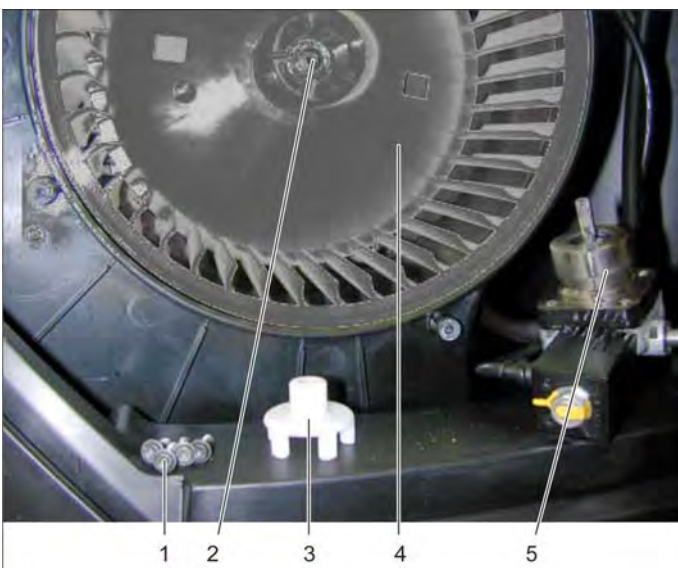

- 1 Fastening screws blower cover
- 2 Fastening screw blower wheel
- 3 Coupling unit
- 4 Blower wheel
- 5 Fuel pump

Burner blower

The blower supplies the burner with combustion air.

The air flap is used to adjust the air value to optimised combustion values.

The blower wheel is mounted to the motor shaft by means of 2 feather keys.

6.21 Booster heater (with ignition transformer)

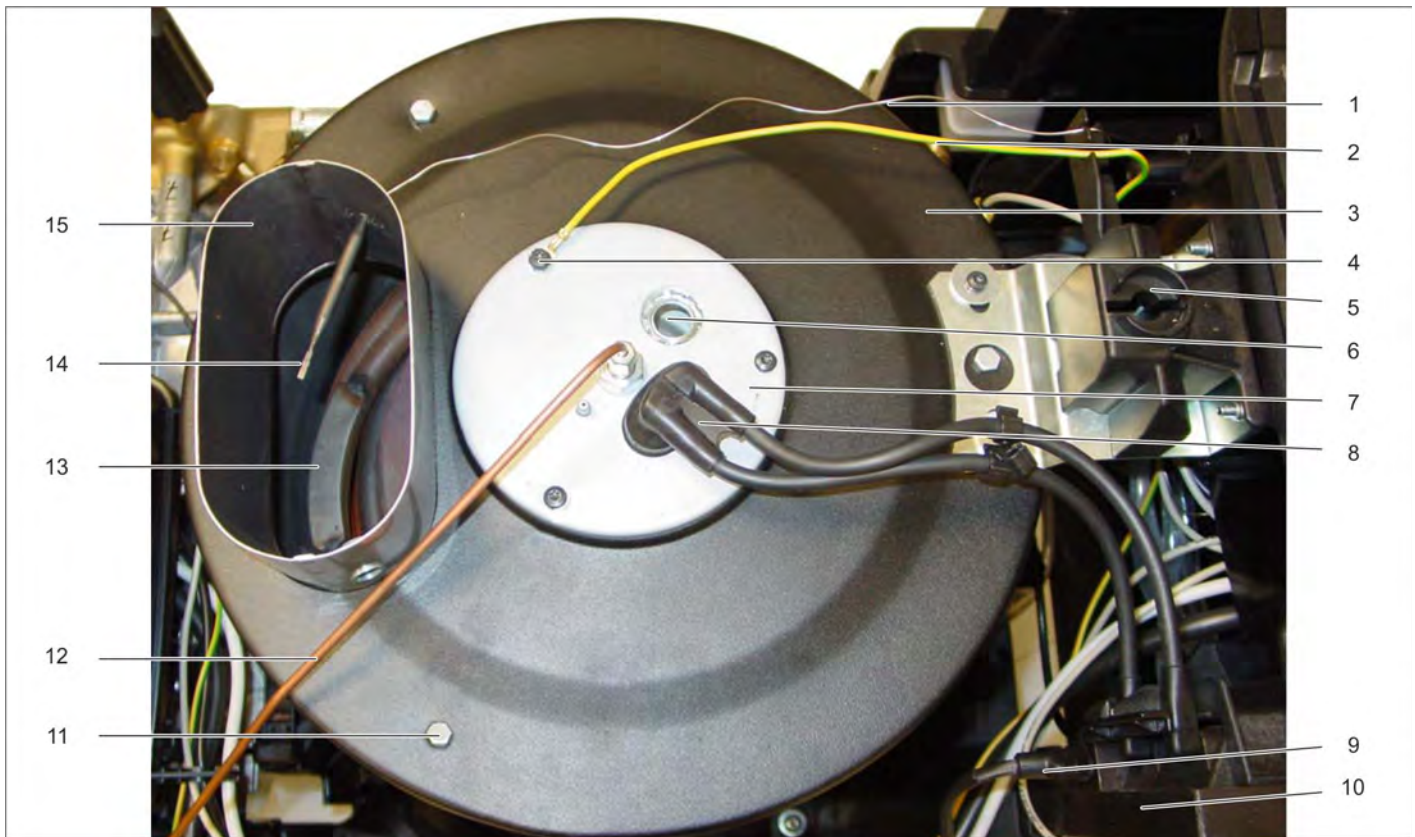

- 1 Capillary exhaust temperature monitor
- 2 Protective conductor
- 3 Cover
- 4 Screws burner
- 5 Locking screw for appliance hood
- 6 Sight glass, ignition monitoring (option)
- 7 Burner
- 8 Ignition cable

- 9 Connection cable ignition transformer
- 10 Ignition transformer
- 11 Screw burner cover
- 12 Fuel line
- 13 Heating coil with type plate
- 14 Exhaust temperature sensor
- 15 Exhaust nozzle

6.22 Booster heater (with ignition transformer new)

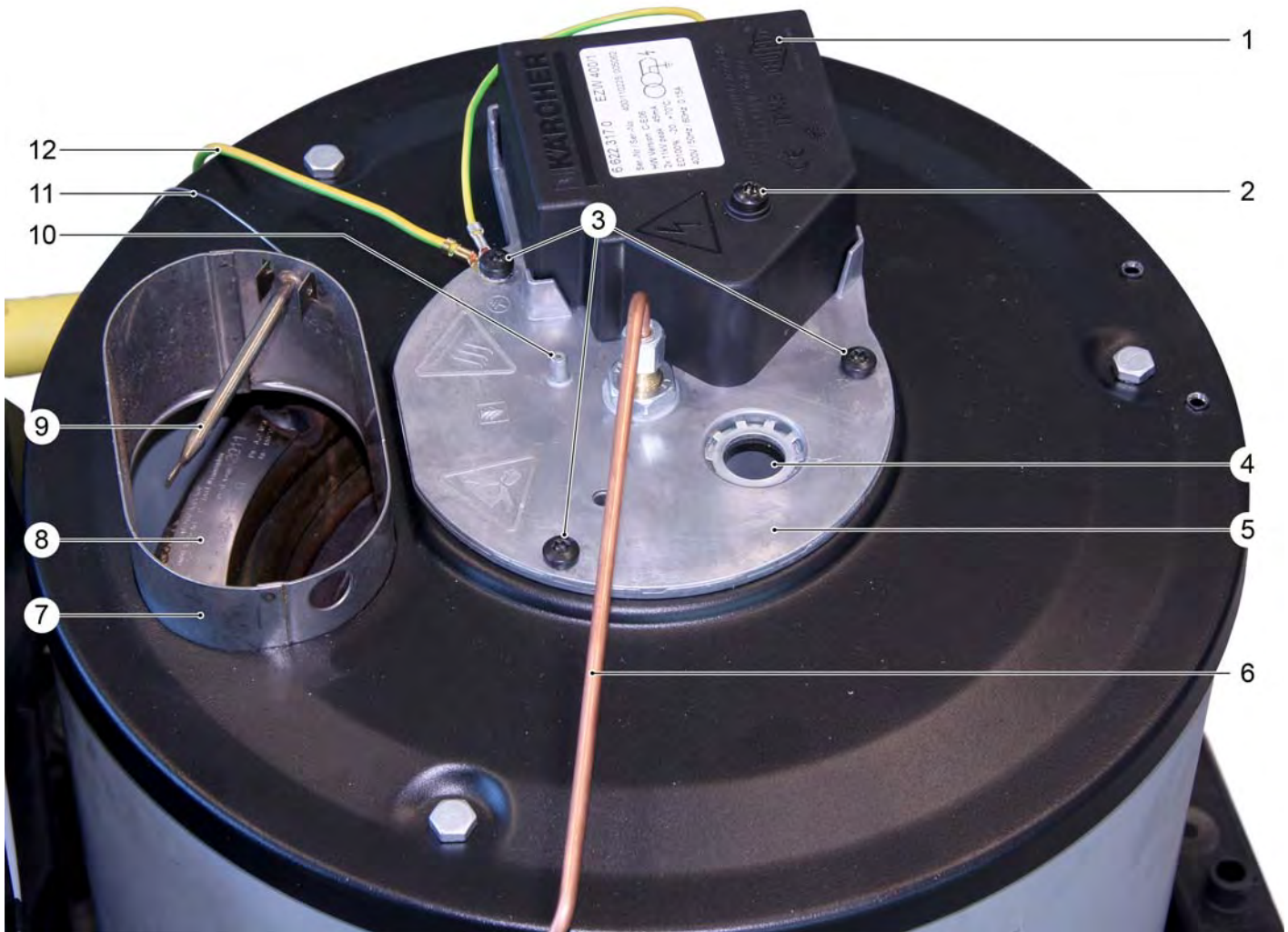

- | | |
|---|--|
| 1 Electronic ignition transformer | 7 Exhaust nozzle, on-demand heater |
| 2 Fastening screw of ignition transformer | 8 Type plate of heating coil |
| 3 Screws for burner cover (3 x) | 9 Exhaust temperature sensor |
| 4 Sight glass, ignition monitoring (option) | 10 Connection for air pressure measurement |
| 5 Burner cover | 11 Capillary exhaust temperature monitor |
| 6 Fuel line | 12 Protective conductor |

6.22.1 Type plate of heating coil

The type plate of the heating coil can be read through the exhaust stack.

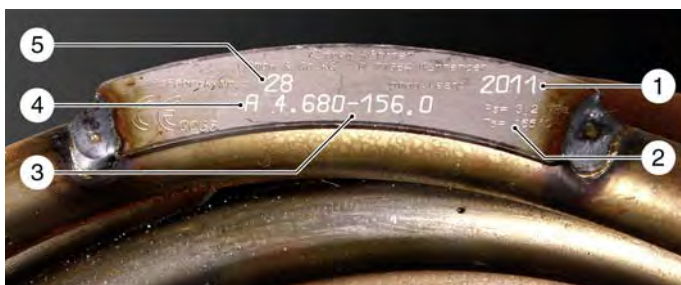

- | |
|-------------------------------|
| 1 Year of manufacture |
| 2 Specifications |
| 3 Part number of heating coil |
| 4 Pressure test passed |
| 5 Continuous plant number |

6.22.2 Ignition transformer

Various ignition transformers are installed in the devices.

With older devices or devices for special voltages the conventional ignition transformers are still used.

Electronic ignition transformer

The integrated electronic ignition transformer (see picture above) is meanwhile used for all devices, except the devices for special voltages. The electronic ignition transformer is installed directly on the burner and secured with a screw that is accessible from the top. Ignition cables are not required.

Ignition transformer of conventional type with ignition cable

6.22.3 Flame sensor with holder on the burner

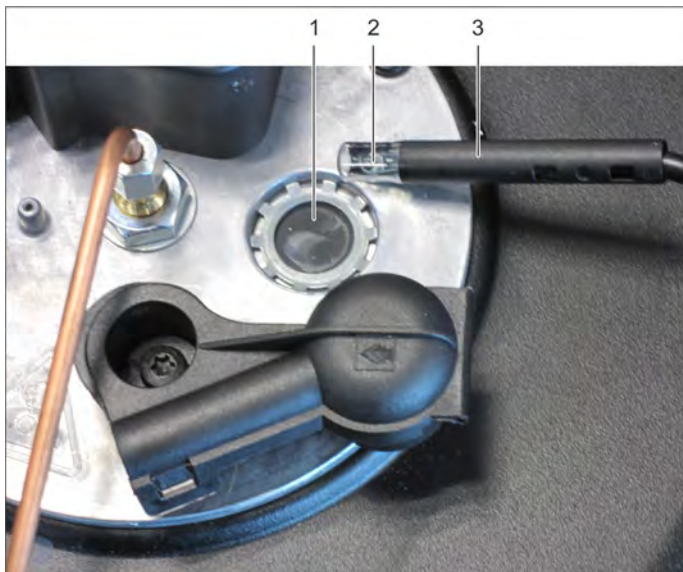

- 1 Looking glass
- 2 Light sensor
- 3 Flame sensor

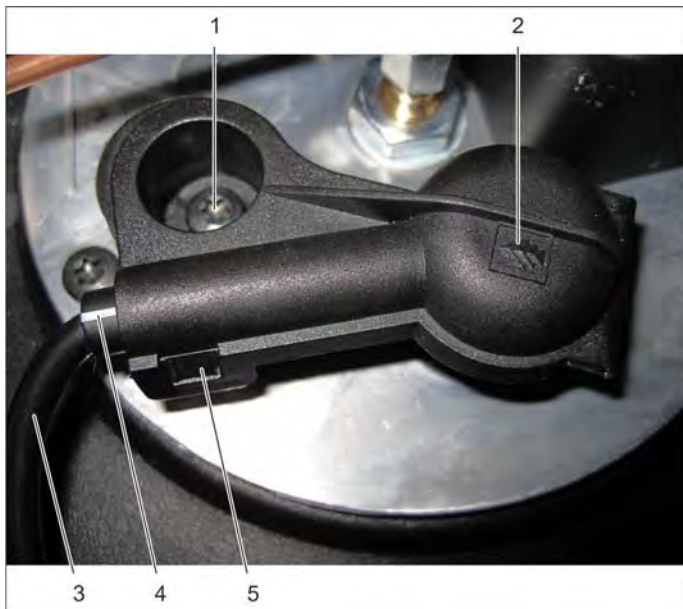

- 1 Screw
- 2 Holder flame sensor
- 3 Flame sensor
- 4 Marking
- 5 Lock

6.22.4 Sectional view booster heater

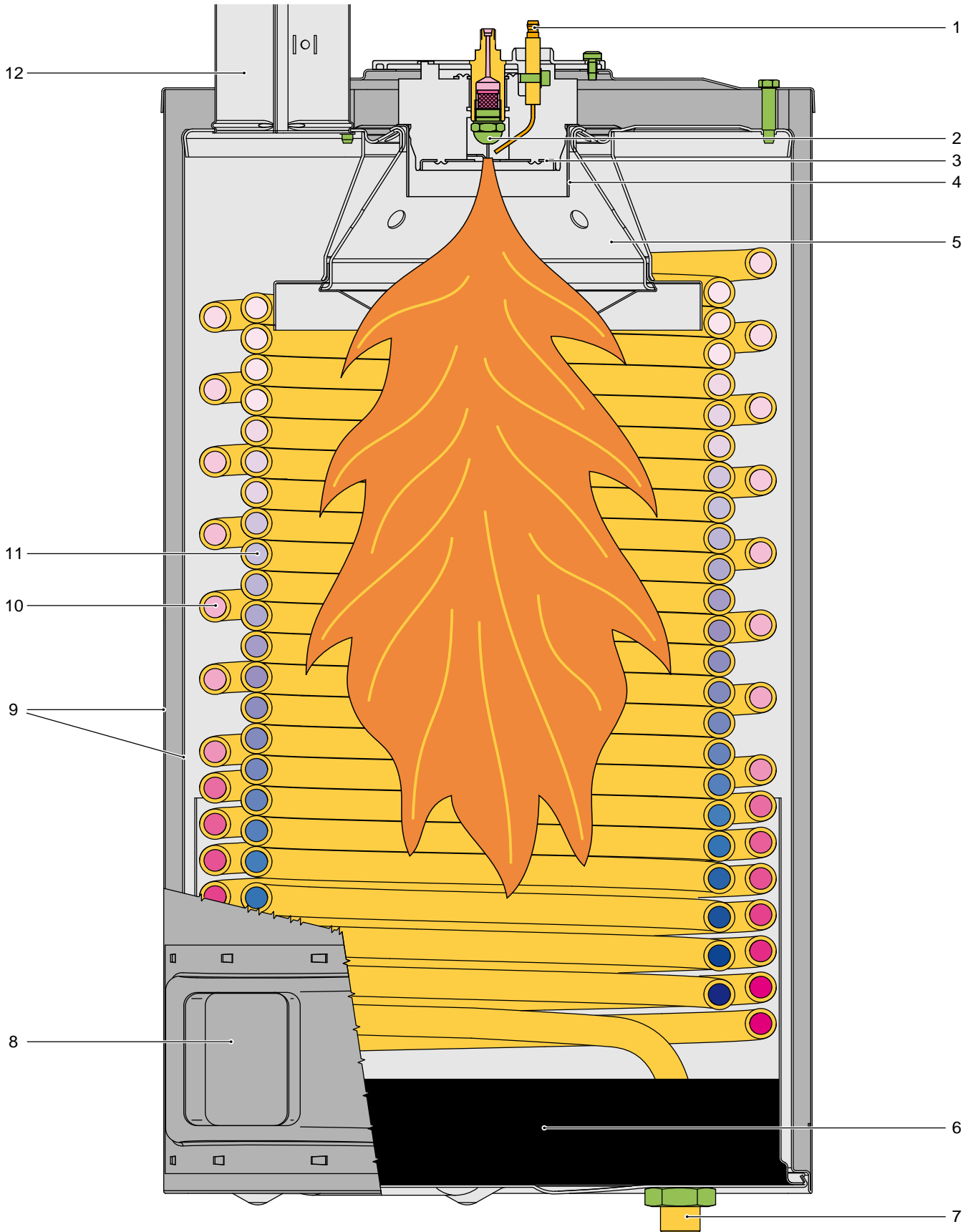

- 1 Ignition electrodes
- 2 Fuel nozzle
- 3 Pressure plate
- 4 Flame ring
- 5 Burning chamber
- 6 Boiler floor
- 7 Boiler input
- 8 Air supply from burner blower

- 9 Boiler exterior, double-walled
- 10 Heating coil spiral, exterior
- 11 Heating coil spiral, interior
- 12 Exhaust nozzle, on-demand heater

Mode of operation

The water from the high pressure pump enters the interior heating coil spiral, is heated while flowing through and exits to the bottom from the heating coil spiral.

The fuel is vaporised by the fuel nozzle and ignited by the spark of the ignition electrodes.

The combustion air from the blower first flows through the double-walled boiler exterior toward the top, then it flows downward with the flame and is emitted as exhaust through the exhaust stack toward the top into the atmosphere.

The boiler floor is made of fire-resistant insulating concrete. It prevents a radiation of the heat and is used to re-route the flames.

The adjustment of the burner to good exhaust values is achieved via the air flap on the blower (air volume) and with the adjustment screw on the fuel pump (fuel pressure).

The temperature increase with the full water volume is 60-65 K independent of the device.

If the water volume is reduced via the pressure and volume control, the water can be heated to approx. 100 °C; if you use the steam nozzle, up to 155 °C.

An optimal burner performance is only possible if the heating coil is neither full of soot nor other deposits.

Furthermore, the spark electrodes, the amount of fuel and the amount of air must be adjusted properly.

Steam operation

The following preparations must be made for steam operation:

- Install steam nozzle
- Set the operating pressure on the pressure and volume control on the pump to the lowest value
- Set the desired steam temperature at the operating panel

Note

As per pressure device guidelines, the operating pressure inside the appliance must be less than 32 bars for steam operation.

This is ensured by reducing the operating pressure on the pressure and volume control and by using the supplied steam nozzle.

6.23 Burner

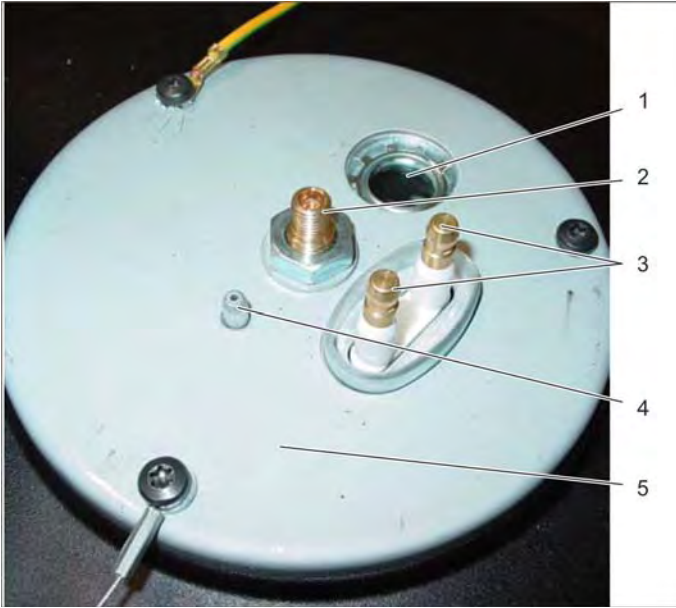

- 1 Looking glass
- 2 Connection pressure line
- 3 Connection ignition electrode
- 4 Connection for air pressure measurement
- 5 Burner cover

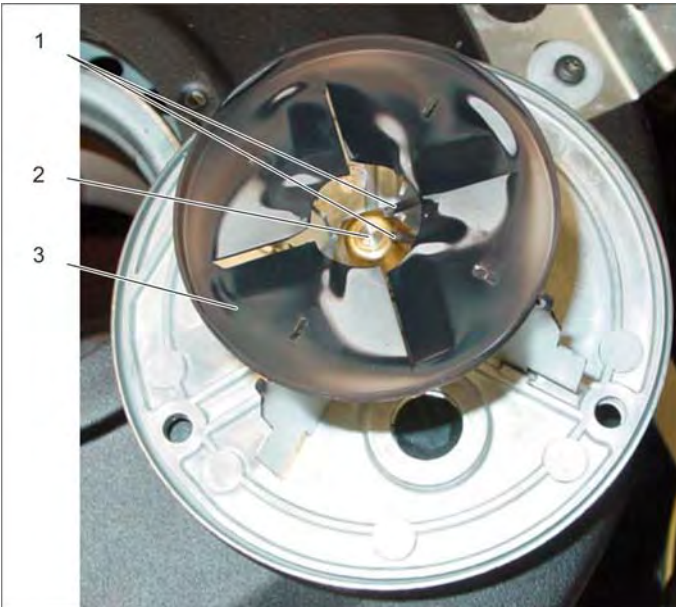

- 1 Ignition electrode
- 2 Fuel nozzle
- 3 Pressure plate

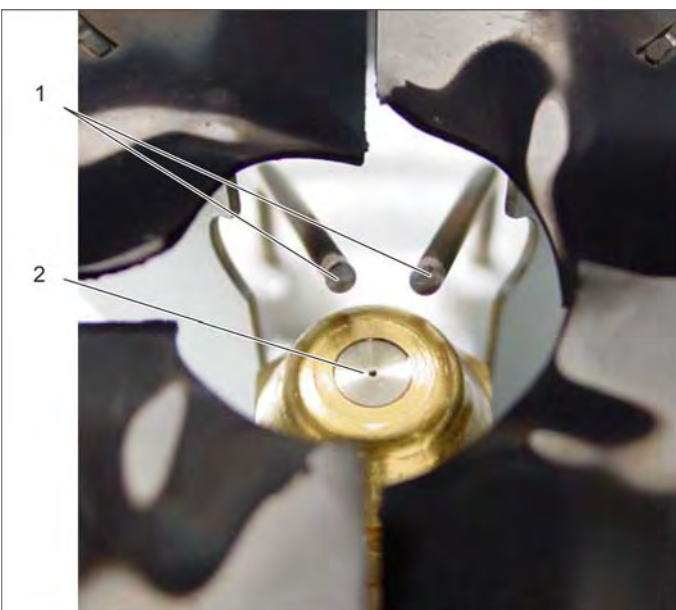

- 1 Ignition electrode
- 2 Fuel nozzle

6.24 Burner

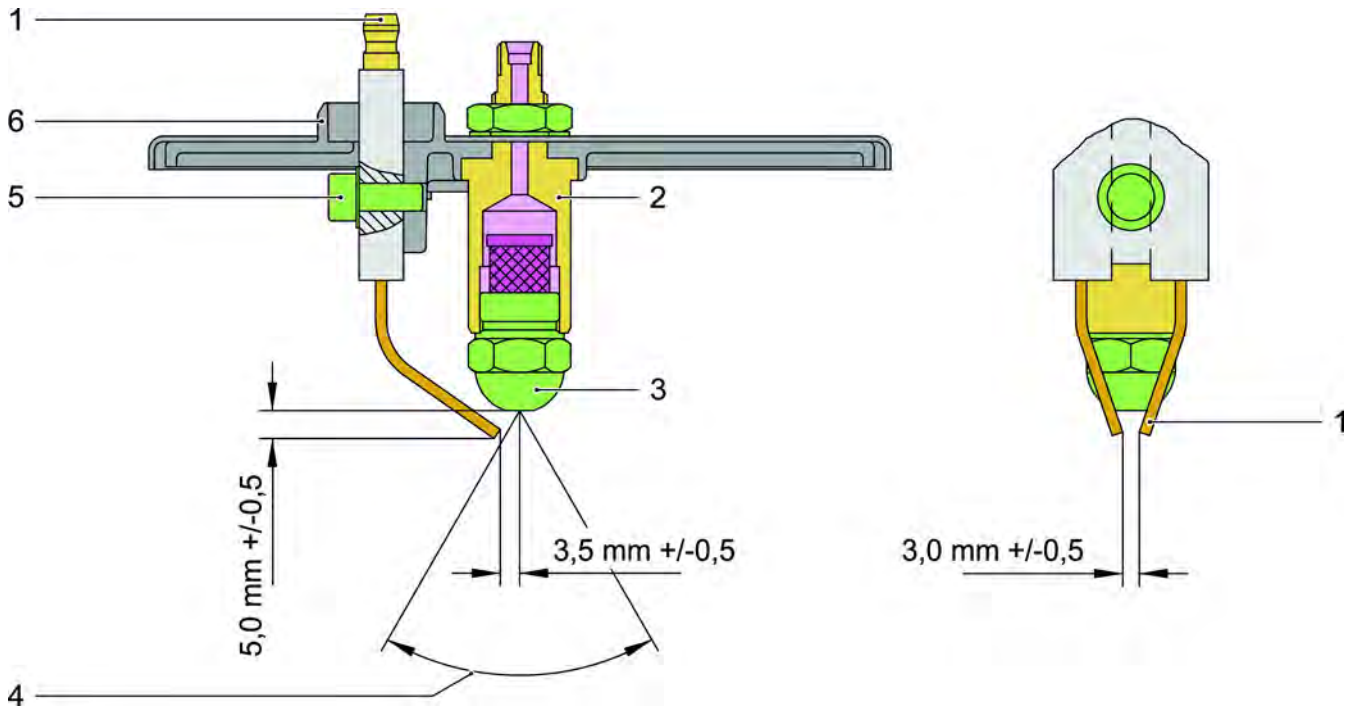

- 1 Ignition electrodes
- 2 Fuel nozzle holder
- 3 Fuel nozzle
- 4 Spray angle 45° or 60°, depending on the type of appliance
- 5 Screw
- 6 Burner cover

Burner

There is a strong spark created between the two ignition electrodes to ensure that the injected fuel will ignite. The necessary ignition voltage is generated by the ignition transformer.

The exact adherence to the adjustment dimensions is a basic requirement for the proper function of the burner, for good exhaust values and the long idle time of the ignition electrodes.

There is always a ignition spark between the two ignition electrodes, during cold and hot water operation (continuous ignition).

This is a safety measure, so that injected fuel will be ignited in any case and cannot accumulate unburned in the on-demand heater (deflagration hazard).

6.25 Output, booster heater

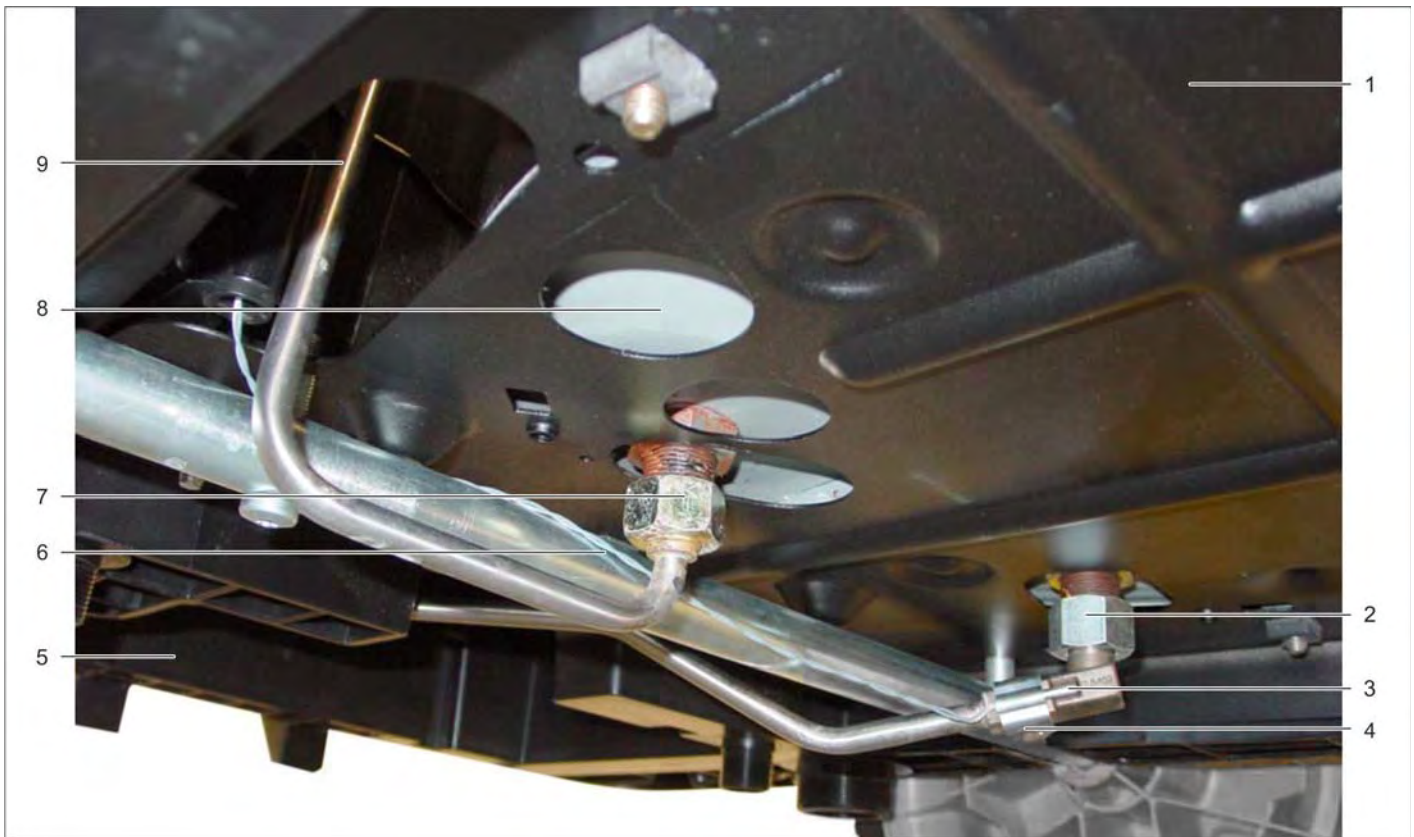

- | | | | |
|---|----------------------------|---|-------------------------------------|
| 1 | Floor plate | 6 | Connecting cable temperature sensor |
| 2 | Output of flow-type heater | 7 | Input of flow-type heater |
| 3 | Temperature sensor water | 8 | Bottom booster heater |
| 4 | Clamping bracket | 9 | Pressure line of the safety block |
| 5 | Chassis | | |

6.26 Hand spraygun

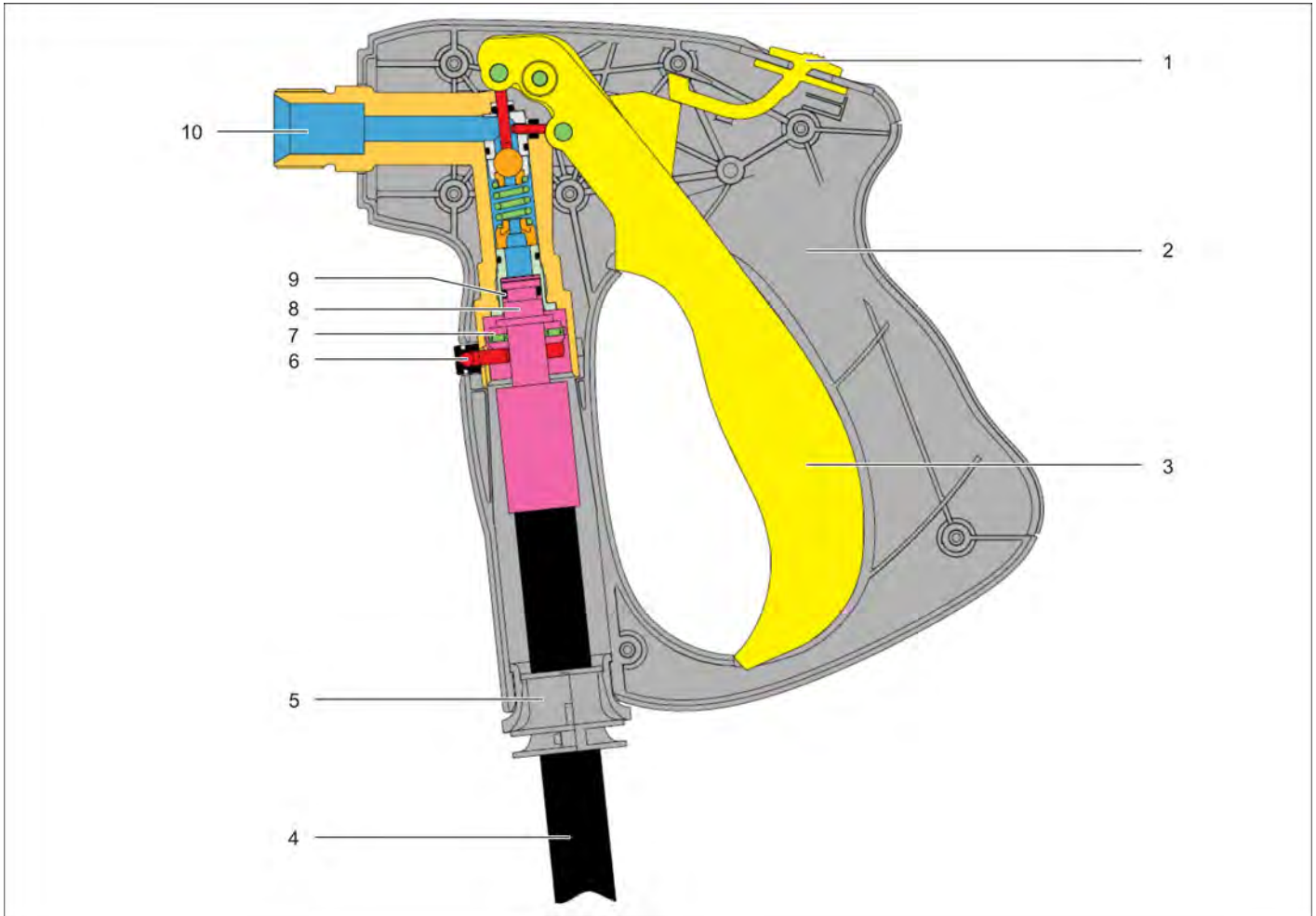

- 1 Lock trigger gun
- 2 Casing shell
- 3 Hand lever
- 4 High pressure hose
- 5 Hose guide
- 6 Safety clip
- 7 Needle bearing
- 8 Coupling high-pressure hose/trigger gun
- 9 O ring
- 10 Node piece

Function

When the manual lever is actuated, the valve in the node piece opens and the water can flow from the hose through the gun into the spray lance.

Note

The node piece cannot be repaired and must be replaced as a complete unit.

The date of manufacture is imprinted on the node piece. It is composed of the month (letters A to L for January through December) and year (1-digit number 1 for 2011, 2 for 2012, etc.).

Example: H1 = August 2011

6.27 Pressure and volume regulation

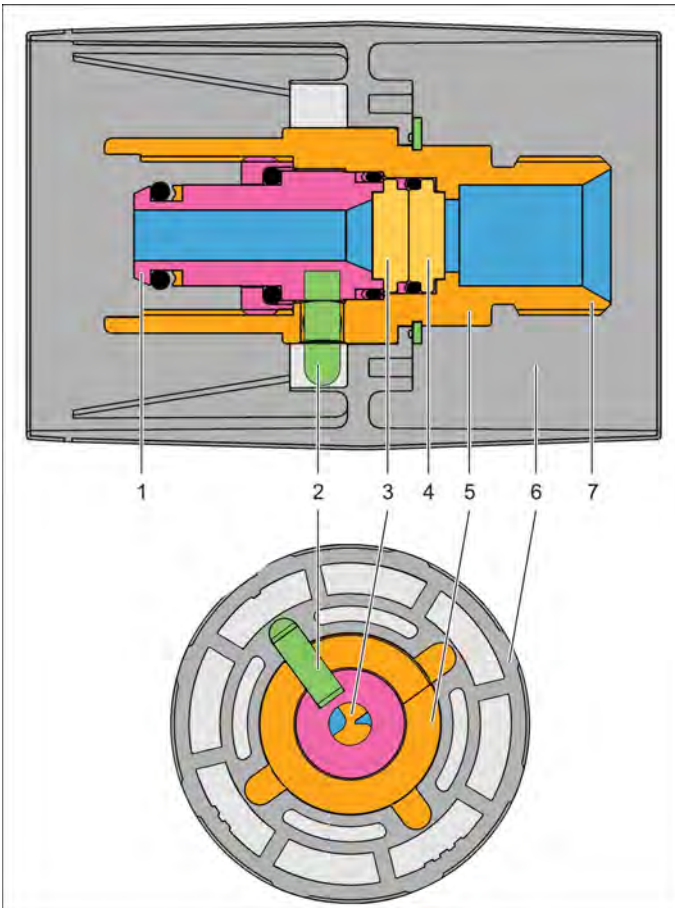

- 1 Connection trigger gun
- 2 Connecting pin
- 3 Ceramic disc on gun side
- 4 Ceramic disc on spray pipe side
- 5 Casing of rotating regulator
- 6 Handle of rotary regulator
- 7 Spray lance connection

The pressure and volume regulation is designed as a rotary regulator between the trigger gun and the spray lance. There are two ceramic discs within the high pressure channel.

A ceramic disc is rigidly connected with the connection of the trigger gun. The other ceramic disc is connected to the rotating regulator and therefore adjustable. Offset holes in the ceramic discs can adjust the flow volume and the pressure when rotating the discs.

This illustration shows the two overlapping ceramic discs and the water flow (blue) with different opening angles (from 0° to 90°).

With the minimal setting, the water flows through a small hose in the middle of the ceramic discs.

Note

The rotary regulator cannot be repaired and must be replaced as a complete unit.

Water flow with opening angle 0° - 90°

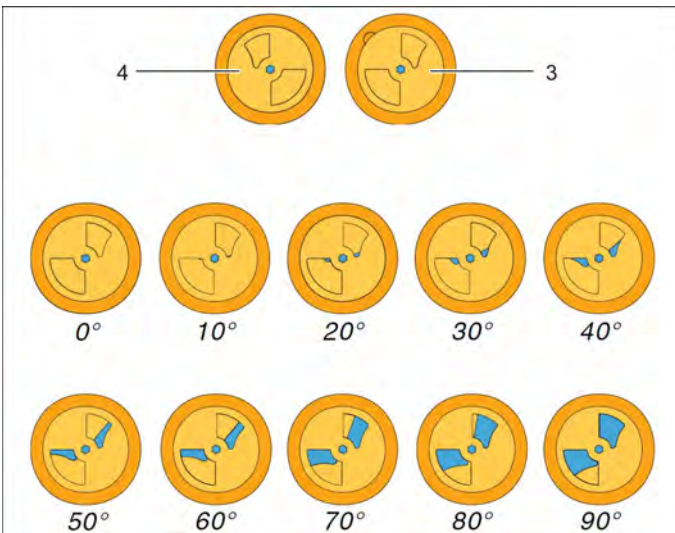

6.28 Functional diagram of pressure water operation (water-cooled motor)

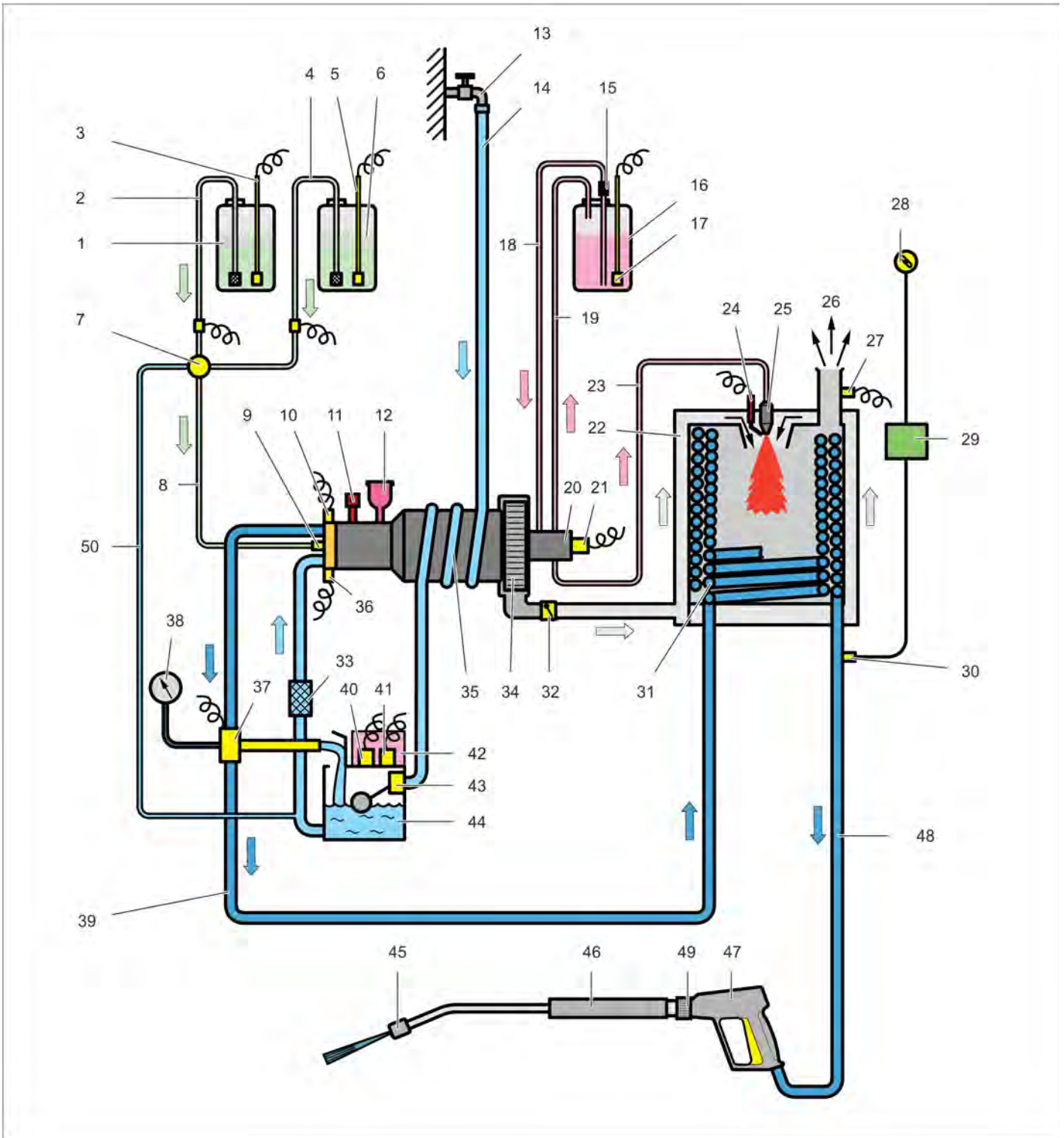

- 1 Detergent tank 1, volume 10 l
- 2 Detergent suction hose with filter
- 3 Level sensor, detergent tank 1 (option)
- 4 Detergent suction hose with filter
- 5 Level sensor, detergent tank 2 (option)
- 6 Detergent tank 2, volume 20 l
- 7 Dosage valve for detergent
- 8 Suction hose for detergent
- 9 Detergent check valve
- 10 Pressure switch ON
- 11 Pressure and volume regulation
- 12 Oil tank
- 13 Water connection
- 14 Water supply hose
- 15 Fuel filter
- 16 Fuel tank
- 17 Level sensor for fuel tank
- 18 Fuel suction hose
- 19 Fuel return line
- 20 Fuel pump
- 21 Solenoid valve, fuel pump
- 22 Continuous heater
- 23 Fuel pressure line
- 24 Ignition electrodes
- 25 Fuel nozzle
- 26 Exhaust nozzle
- 27 Exhaust temperature sensor
- 28 Setting, water temperature
- 29 Printed circuit board (PCB)
- 30 Temperature sensor
- 31 Heating coil
- 32 Air flap
- 33 Water fine filter
- 34 Burner blower
- 35 Motor casing with cooling coil
- 36 Pressure switch OFF
- 37 Safety block with water shortage safeguard and safety valve
- 38 Manometer
- 39 Pressure pipe
- 40 Solenoid valve liquid softener
- 41 Level sensor liquid softener
- 42 Liquid softener reservoir
- 43 Swimmer valve
- 44 Float tank
- 45 High pressure nozzle
- 46 Spray lance
- 47 Trigger gun
- 48 High pressure hose
- 49 Rotary regulator for pressure and quantity regulation
- 50 Rinse line

6.29 Functional diagram vacuuming operation

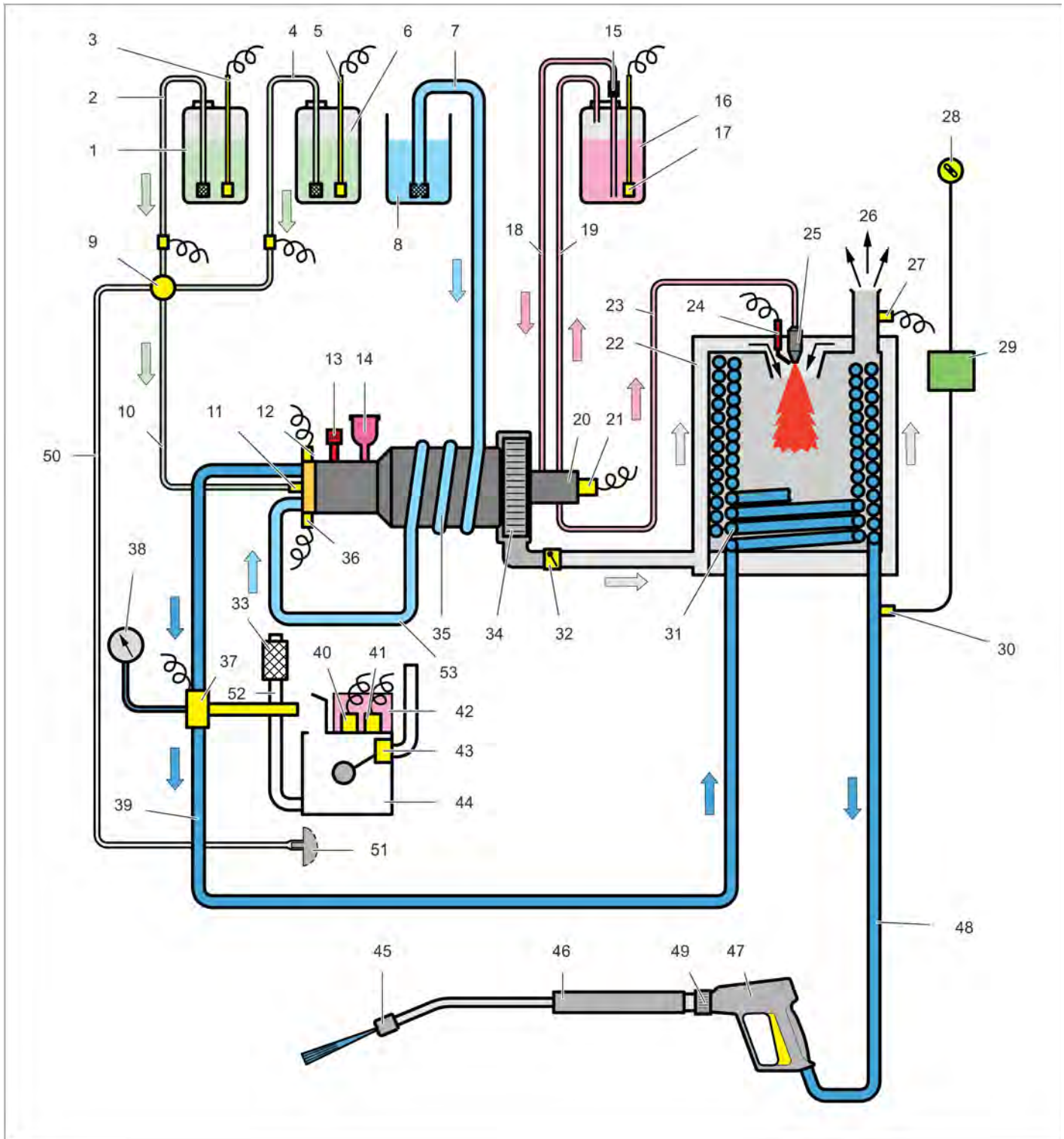

- 1 Detergent tank 1
- 2 Detergent suction hose with filter
- 3 Level sensor, detergent tank 1
- 4 Detergent suction hose with filter
- 5 Level sensor, detergent tank 2
- 6 Detergent tank 2
- 7 Suction hose with filter and check valve
- 8 Open container
- 9 Dosage valve for detergent
- 10 Suction hose for detergent
- 11 Detergent check valve
- 12 Pressure switch ON
- 13 Pressure and volume regulation
- 14 Oil tank
- 15 Fuel filter
- 16 Fuel tank
- 17 Level sensor for fuel tank
- 18 Fuel suction hose
- 19 Fuel return line
- 20 Fuel pump
- 21 Solenoid valve, fuel pump
- 22 Continuous heater
- 23 Fuel pressure line
- 24 Ignition electrodes
- 25 Fuel nozzle
- 26 Exhaust nozzle
- 27 Exhaust temperature sensor
- 28 Setting, water temperature
- 29 Printed circuit board (PCB)
- 30 Temperature sensor
- 31 Heating coil
- 32 Air flap
- 33 Water fine filter
- 34 Burner blower
- 35 Motor casing with cooling coil
- 36 Pressure switch OFF
- 37 Safety block with water shortage safeguard and safety valve
- 38 Manometer
- 39 Pressure pipe
- 40 Solenoid valve liquid softener
- 41 Level sensor liquid softener
- 42 Liquid softener reservoir
- 43 Swimmer valve
- 44 Float tank
- 45 High pressure nozzle
- 46 Spray lance
- 47 Trigger gun
- 48 High pressure hose
- 49 Rotary regulator for pressure and quantity regulation
- 50 Rinse line
- 51 Slot (plug) vacuuming operations
- 52 Hose to the fine filter
- 53 Hose from the motor cooling to the pump

Note

During vacuuming operations, the float container must be bypassed.

6.30 Vacuuming operations

Note

If the appliance is used for vacuuming, the rinse hose of the detergent dosing valve must be plugged onto the respective plug to prevent erroneous air suction. Furthermore, the fine filter must be uninstalled and the water supply hose must be connected directly to the high pressure pump.

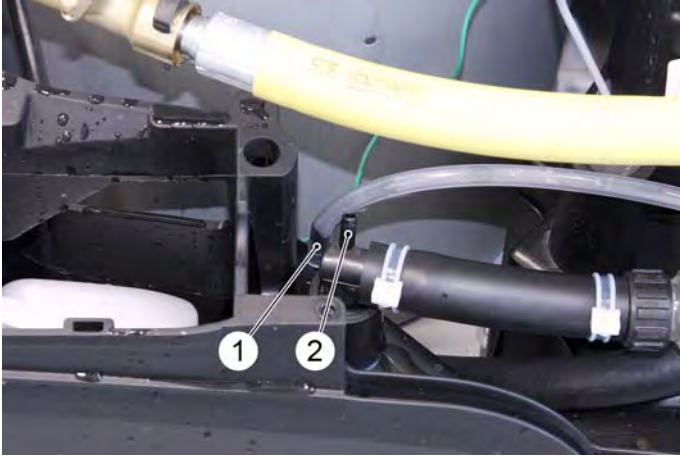

- 1 Slot vacuum operation (plug)
- 2 Slot pressure water operation (connection)

Note

The conversion to vacuuming operations requires bypassing of the float container.

- Remove the liquid softener bottle and turn it over immediately to avoid spills.
- Open the device hood.
- Unscrew the water filter from the high-pressure pump inlet.
- Unscrew the water hose from the float valve and screw it onto the high-pressure pump inlet.
- Pull the rinse hose off the connection on the float container output and plug it onto the stopper.

⚠ CAUTION

When replacing the liquid softener reservoir, make sure that the cables from the solenoid valve and level sensor are not crushed.

- Place the liquid softener tank onto the swimmer reservoir.

Until the pump has sucked in water

- Set the pressure/quantity regulation at the pump unit to maximum quantity.
- Close the dosing valve for the detergent.

Note

The suction hose with filter (accessory) must have a minimum diameter of 3/4".

The suction height is max. 0.5 m.

6.31 Pressure and volume regulation

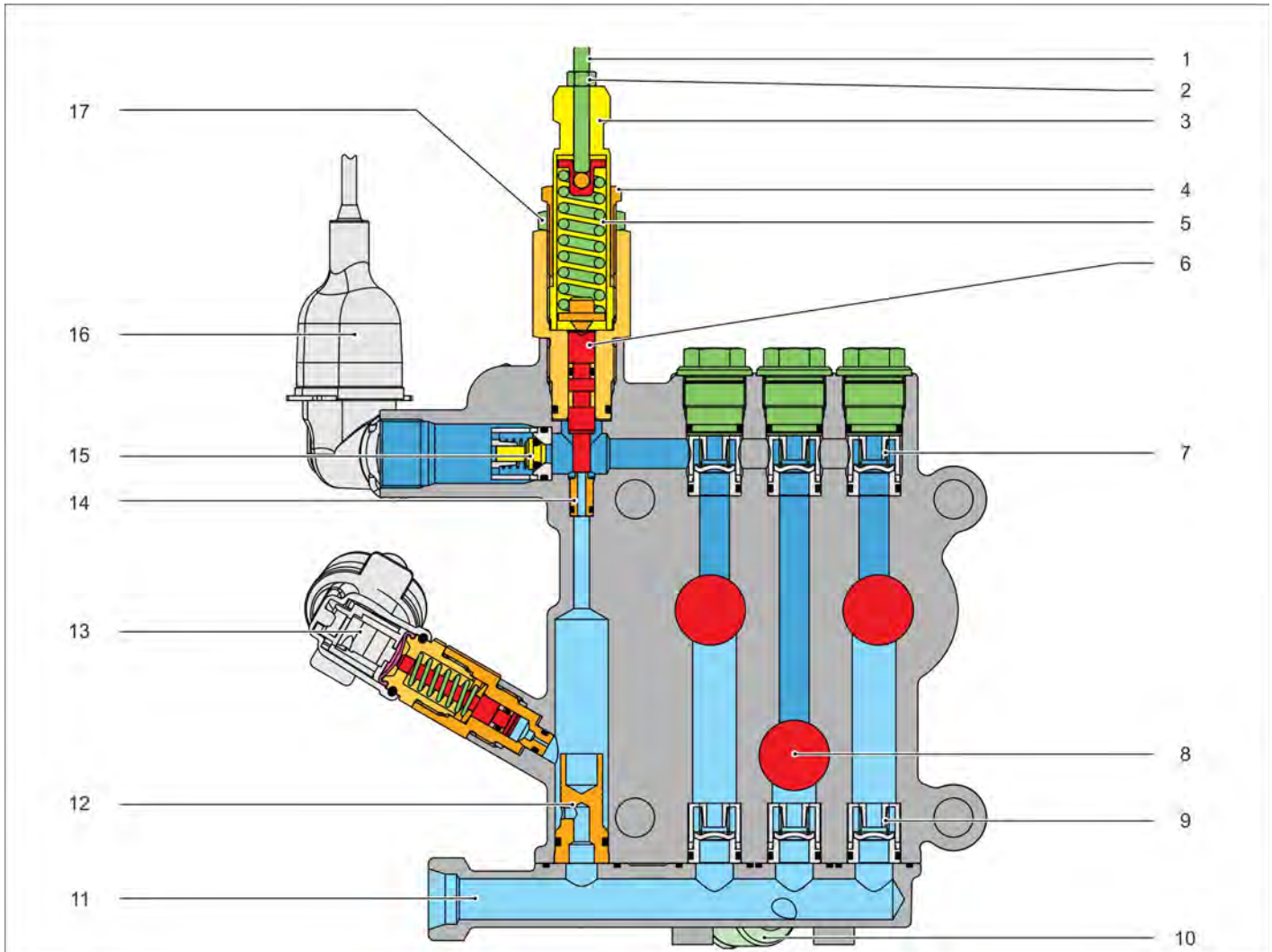

- | | |
|---------------------------------------|---|
| 1 Threaded pin, max. pressure setting | 10 Detergent infeed with backflow valve |
| 2 Locknut threaded pin | 11 Suction jumper with water connection |
| 3 Semiload spindle | 12 Sleeve with throttle bore |
| 4 Half-load stop sleeve | 13 Pressure switch "OFF" |
| 5 Pressure spring | 14 Valve seat |
| 6 Overflow piston | 15 Pressure holding valve |
| 7 High pressure valve (3x) | 16 Pressure switch "ON" |
| 8 Pump piston (3x) | 17 Locknut of semiload stop sleeve |
| 9 Suction valve (3x) | |

6.31.1 Function pressure and volume regulation

Manually with a pressure regulator on the high pressure pump

The pressure and volume regulation via the handle on the high pressure pump is used to relieve the motor with mostly partial load operation.

Turning the spindle anticlockwise lowers the pretension of the pressure spring.

This will lift the overflow piston with a lower pressure from the valve seat and part of the flowing volume runs to the suction chamber via the sleeve with the throttle bore.

The pump runs at reduced pressure.

Depending on the spindle setting, the pressure and the water volume change.

With the rotary regulator on the gun

The pressure and volume regulation via the rotary regulator on the gun should only be used during occasional partial load operation.

When the pressure is reduced via the rotary regulator, the manual pressure and volume regulation on the pump must always be opened all the way (direction "+" on the handle); otherwise, the appliance will shut off prematurely.

If the rotary regulator is partially closed, the pressure in the system will increase.

This will lift the piston off the valve seat so that a part of the flowing volume flows back to the suction chamber via the return.

The pump continues to run at high pressure.

Depending on the setting of the rotary regulator on the gun, the pressure and the water volume change.

Gun closed

If the gun is closed completely, the piston will open all the way and the entire flow volume of the pump flows to the suction chamber via the throttle bore.

The dynamic pressure building up through the throttle bore of the sleeve in the return actuates the pressure switch which will in turn shut off the appliance.

6.32 Functional description of pressure switch

6.32.1 Appliance is switched off

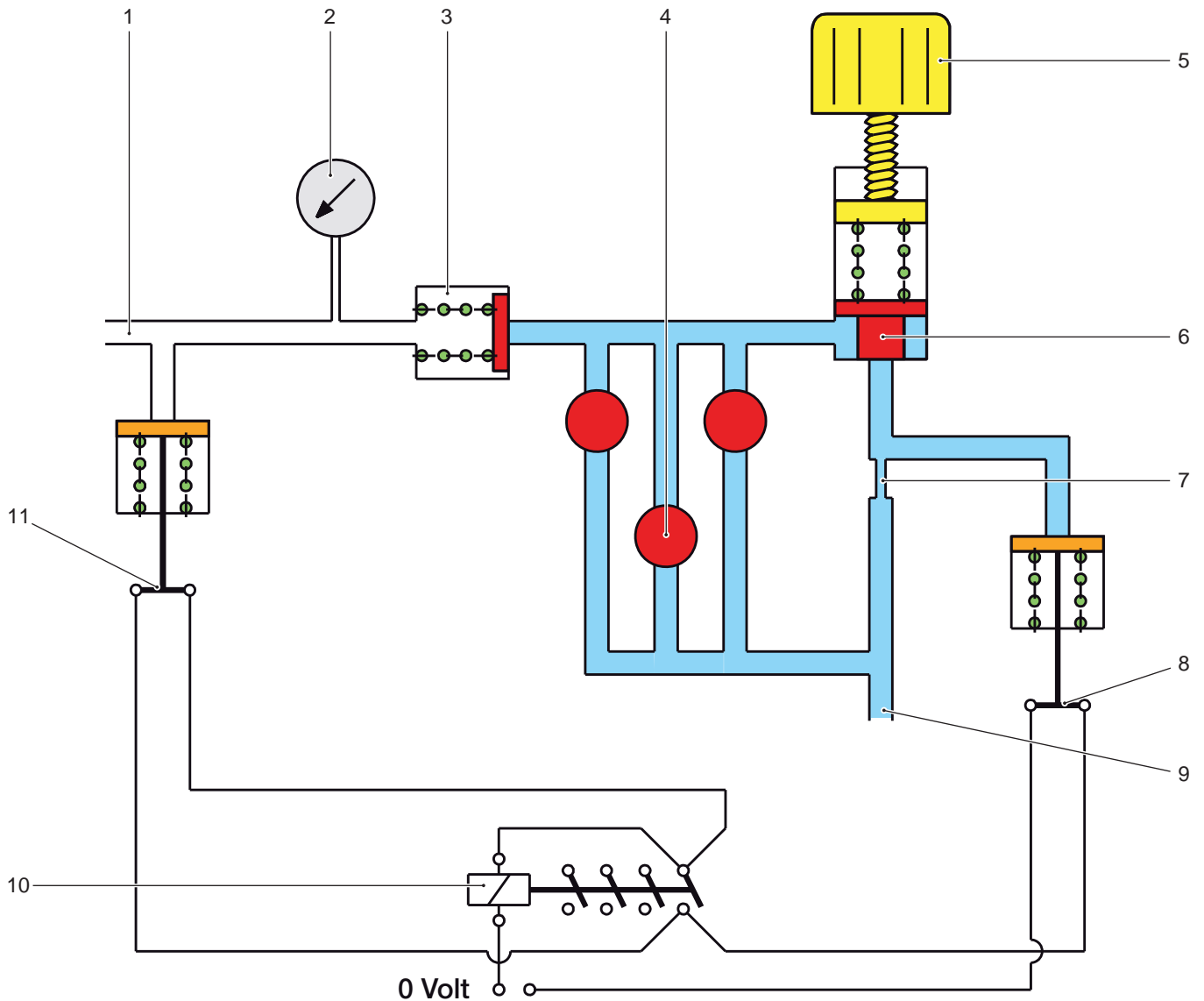

- 1 High pressure outlet (without pressure)
- 2 Manometer (without pressure)
- 3 Pressure retaining valve (closed)
- 4 Pump stands still
- 5 Rotary knob
- 6 Overflow valve (closed)
- 7 Reduction bore
- 8 Pressure switch "OFF" (closed)
- 9 Water inlet
- 10 Motor contactors (K1) (open)
- 11 Pressure switch "ON" (closed)

When the appliance is switched off and the gun is open, the pressure is taken from the system and it is without voltage.

Both pressure switches as well as the overflow valve and the pressure retaining valve closed.

The motor contactors are open.

Note

The shown functions of the pressure switches and motor contactor are for understanding purposes only.

In reality, the information from the two pressure switches is transferred directly to the control electronics, which in turn controls the motor contactor.

6.32.2 The appliance is switched on and the gun is open

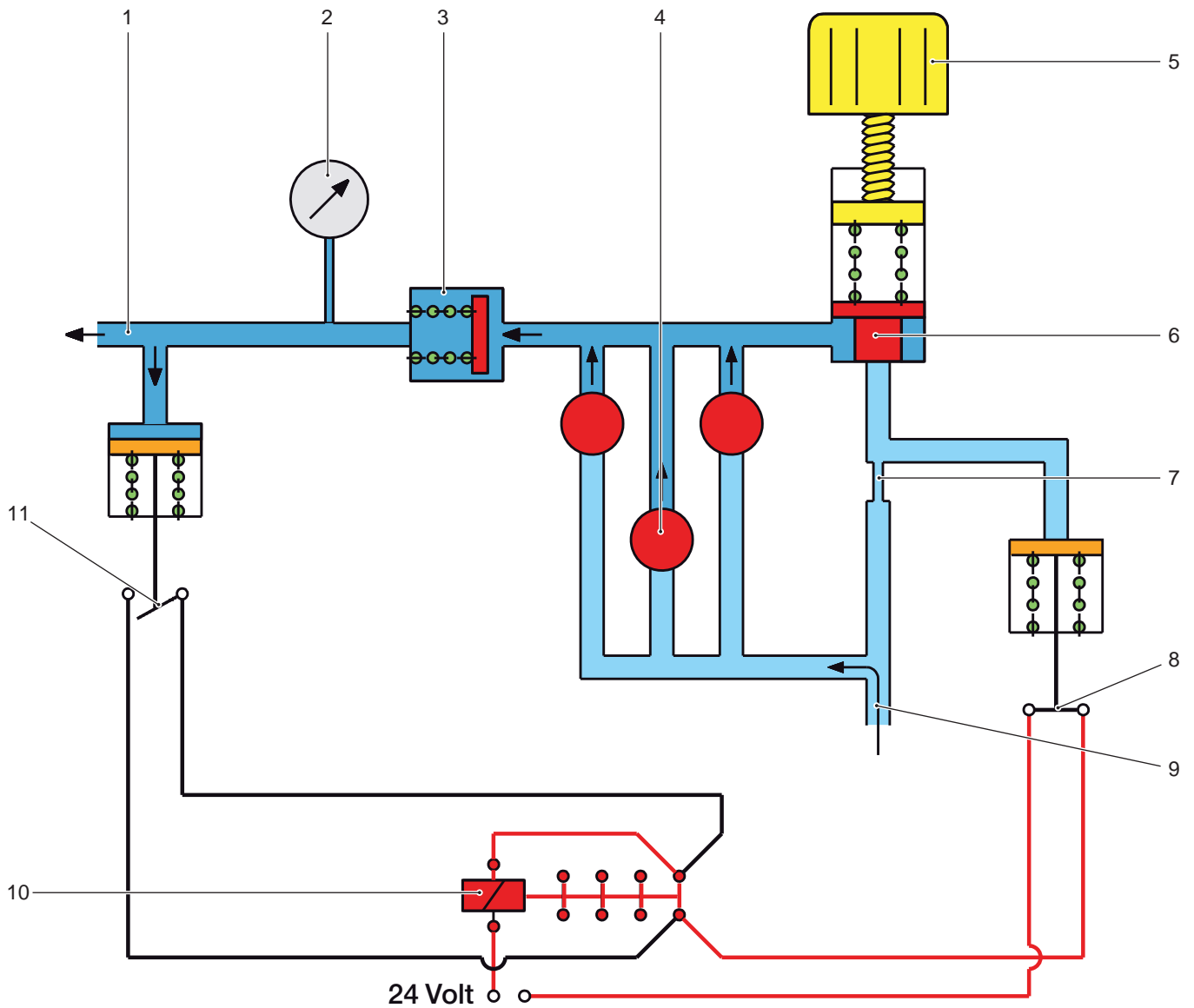

- 1 High pressure outlet, working pressure
- 2 Manometer, working pressure
- 3 Pressure retaining valve (open)
- 4 Pump is running
- 5 Rotary knob
- 6 Overflow valve (closed)
- 7 Reduction bore
- 8 Pressure switch "OFF" (closed)
- 9 Water inlet
- 10 Motor contactors (K1) (closed)
- 11 Pressure switch "ON" (open)

After switching on the appliance and with the gun open, the contactor will be actuated and closes the contacts. This will start the motor and the pump will build up the working pressure. Open the pressure retaining valve and the pressure switch "ON", the overflow valve and the pressure switch "OFF" remain closed. Due to the closed pressure switch, the motor contactors also remain closed.

Note

The shown functions of the pressure switches and motor contactor are for understanding purposes only. In reality, the information from the two pressure switches is transferred directly to the control electronics, which in turn controls the motor contactor.

6.32.3 Gun is closed

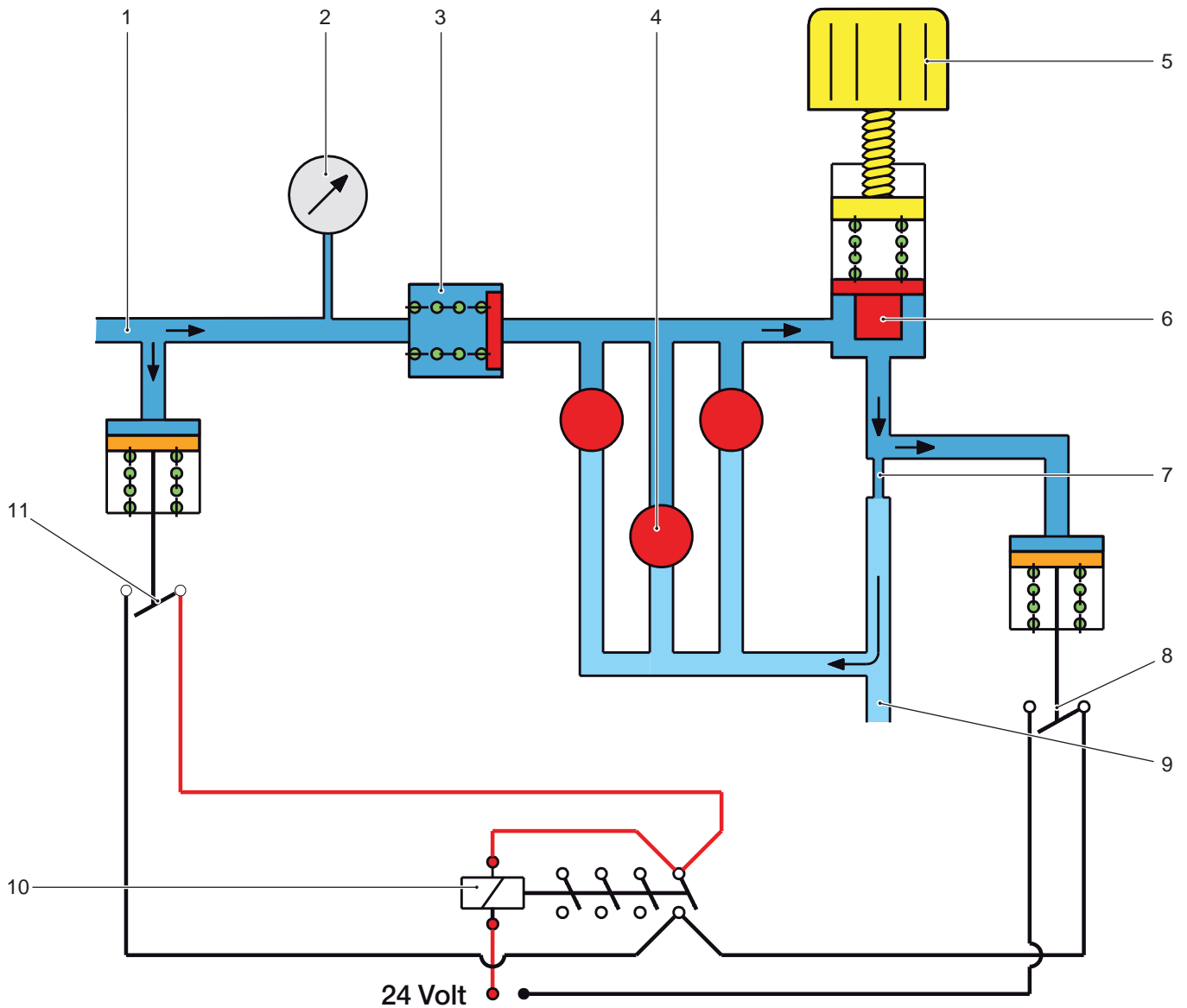

- 1 High pressure outlet, shut-off pressure
- 2 Manometer, shut-off pressure
- 3 Pressure retaining valve (closed)
- 4 Pump stands still
- 5 Rotary knob
- 6 Overflow valve
- 7 Reduction bore
- 8 Pressure switch "OFF" (open)
- 9 Water inlet
- 10 Motor contactors (K1) (open)
- 11 Pressure switch "ON" (open)

Note

The shown functions of the pressure switches and motor contactor are for understanding purposes only. In reality, the information from the two pressure switches is transferred directly to the control electronics, which in turn controls the motor contactor.

There will be brief overpressure in the system when the gun is closed. This will open the overflow valve and the entire flow volume streams into the suction chamber of the pump through the throttle bore.

As soon as the overflow valve opens, the pressure retaining valve closes and the shut-off pressure is locked between the gun and the pressure retaining valve. Due to the locked in switch-off pressure, the pressure switch "ON" remains open. There will be a pressure backup in front of the reduction bore, which opens the pressure switch "OFF" at about 10 bar and thus interrupts the control circuit. The motor contactors open and the motor is shut off. As soon as the motor has stopped, the overflow valve will close and so will the pressure switch "OFF". However, the motor contactors will remain open as the control circuit is still interrupted by the open pressure switches "ON".

6.32.4 The gun is reopened when the appliance is switched on

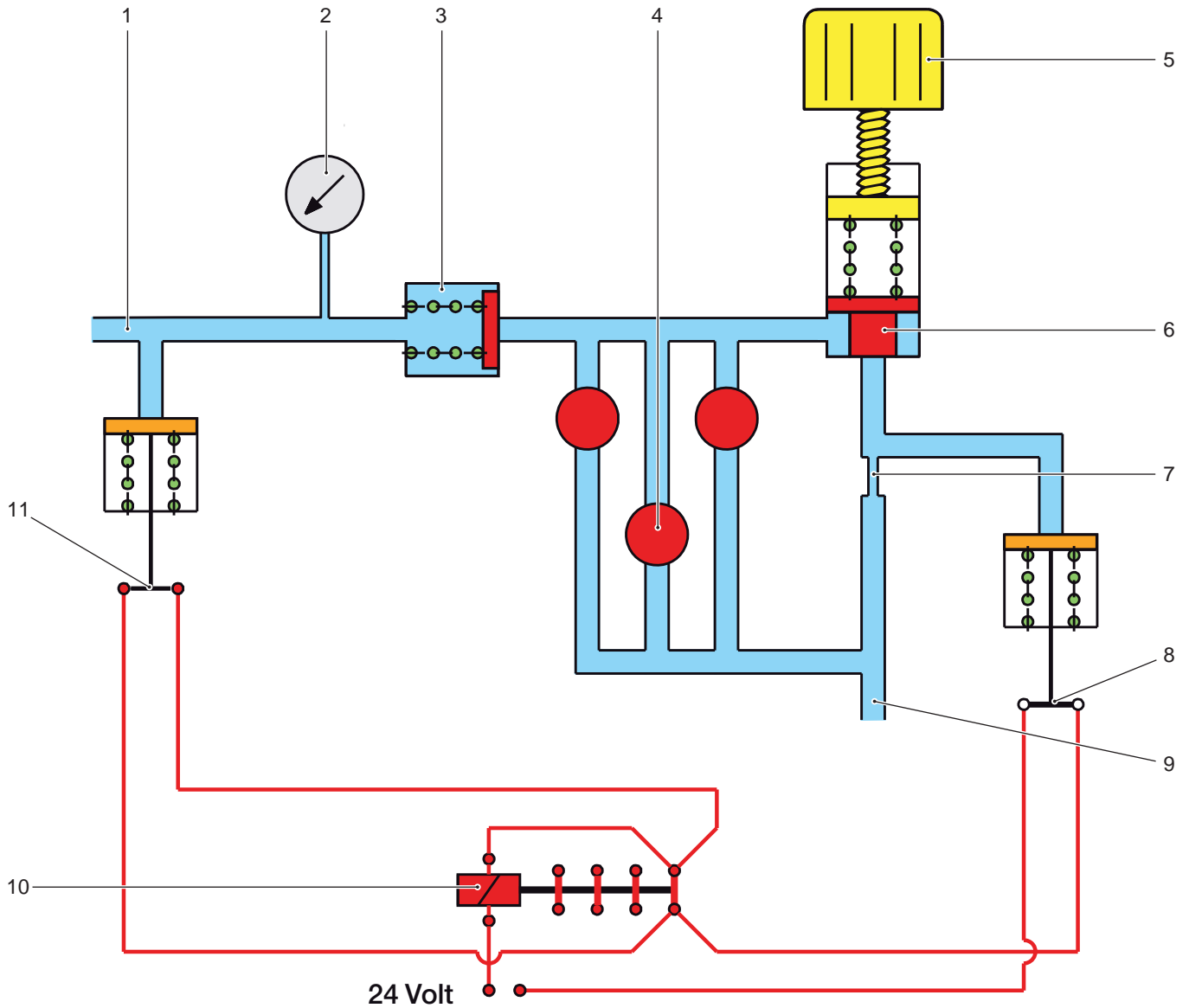

- 1 High pressure outlet (without pressure)
- 2 Manometer (without pressure)
- 3 Pressure retaining valve (closed)
- 4 Pump is running
- 5 Rotary knob
- 6 Overflow valve (closed)
- 7 Reduction bore
- 8 Pressure switch "OFF" (closed)
- 9 Water inlet
- 10 Motor contactors (K1) (closed)
- 11 Pressure switch "ON" (closed)

The pressure switch "ON" closes, which in turn will close the control circuit.
The motor contactor is actuated, closes the contacts, the motor starts up and the pump rebuilds the working pressure.

Note

The shown functions of the pressure switches and motor contactor are for understanding purposes only.
In reality, the information from the two pressure switches is transferred directly to the control electronics, which in turn controls the motor contactor.

As soon as the gun is opened, the pressure that is locked in between the pressure retaining valve and the gun escapes.

7 Basic settings and service procedures

7.1 Remove the hose drum

7.1.1 Uninstall / install high-pressure hose

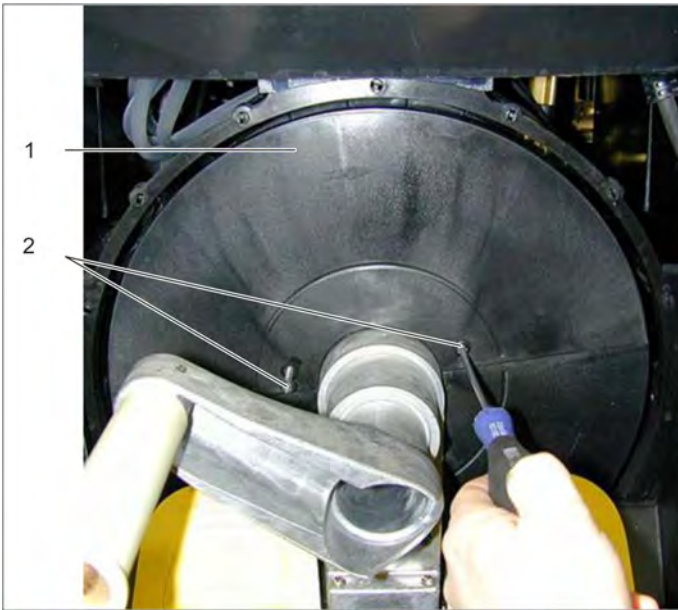

- 1 Casing shell, hose reel
- 2 Screws

- Release pressure.
- Unwind the HP hose from the hose reel.
- Unscrew the screws.
- Remove the casing shell.



- 1 Clip

- Lever out the clamp.
- Pull out the hose.
- Take a new hose through the hose guide and the deflection pulley.
- Slide the hose into the union piece of the hose reel and secure by means of the clamp.

7.1.2 Renew O-rings axle, hose reel

■ 7.1.1 Uninstall / install high-pressure hose

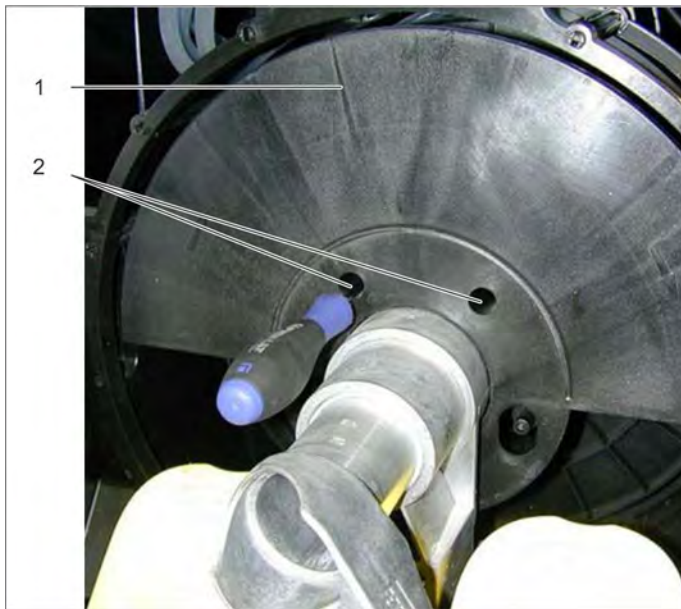
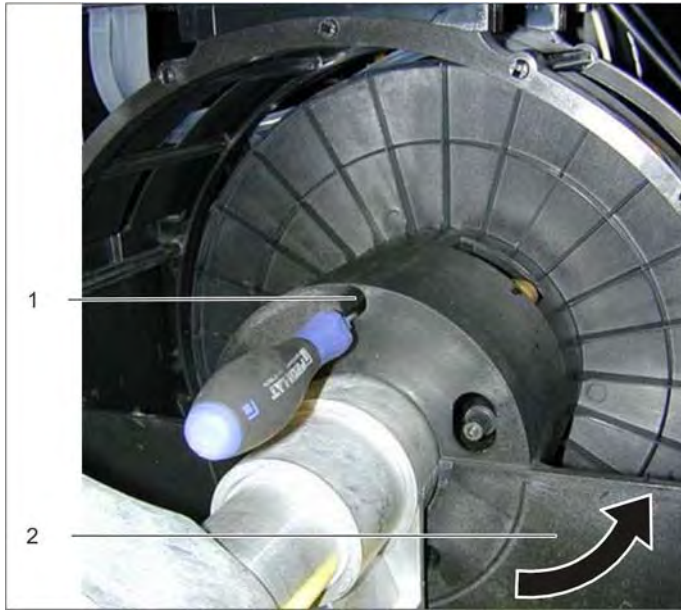



- 1 Casing shell, hose reel
- 2 Bearing block
- 3 Crank

➔ Remove the front part of the hose reel.

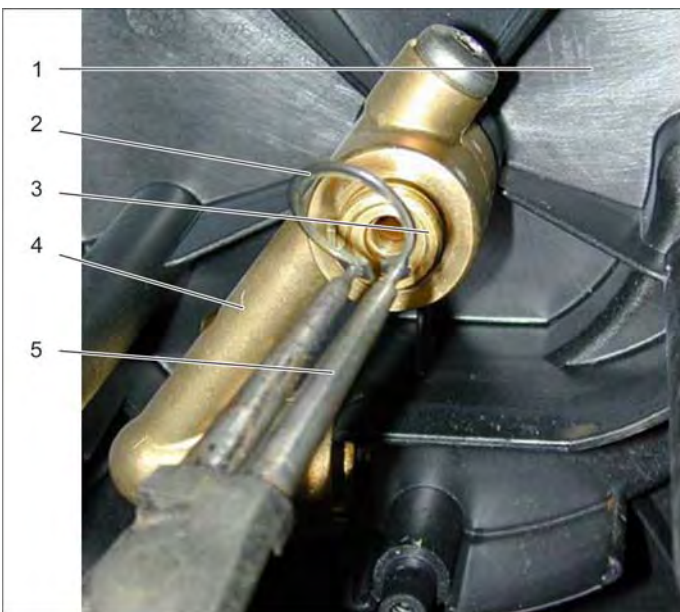

- 1 Hose drum
- 2 Safety ring
- 3 Pipeline with axle
- 4 Node piece
- 5 Pliers

➔ Remove the retaining ring.

➔ Remove the knot.

➔ Remove the rear part of the hose reel.

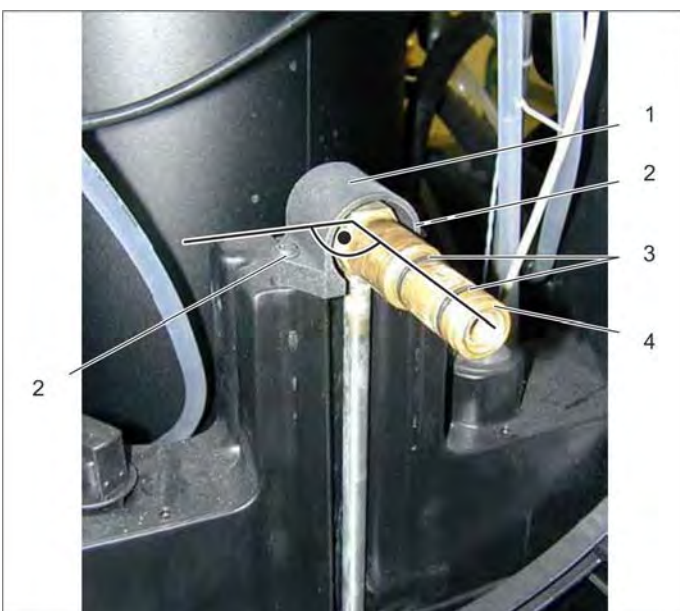

- 1 Rear bearing block
- 2 Screws
- 3 O rings
- 4 Pipeline with axle

➔ Remove O-rings.

Installation information

Replace the O-rings.

Grease the O-rings.

Grease	6.288-088.0
--------	-------------

Note

Check axle and connection piece for signs of wear.

7.1.3 Uninstall / install pipeline with axle

■ 7.1.2 Renew O-rings axle, hose reel

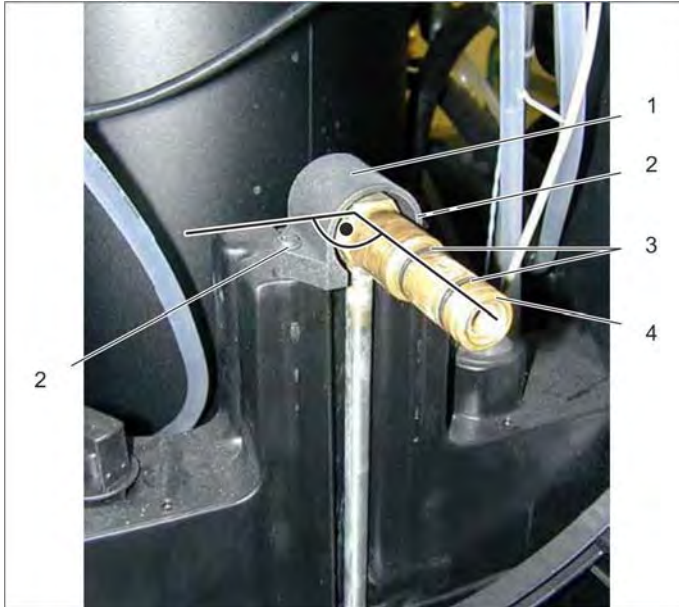

- 1 Rear bearing block
- 2 Screws
- 3 O rings
- 4 Pipeline with axle

Note

Align the pipeline with axle at a right angle to the rear bearing block.



- 1 Pipeline with axle
- 2 Screw connection
- 3 Wrench

- ➔ Disconnect screw connection.
- ➔ Remove pipeline with axle.

7.2 Uninstall / install pressure gauge

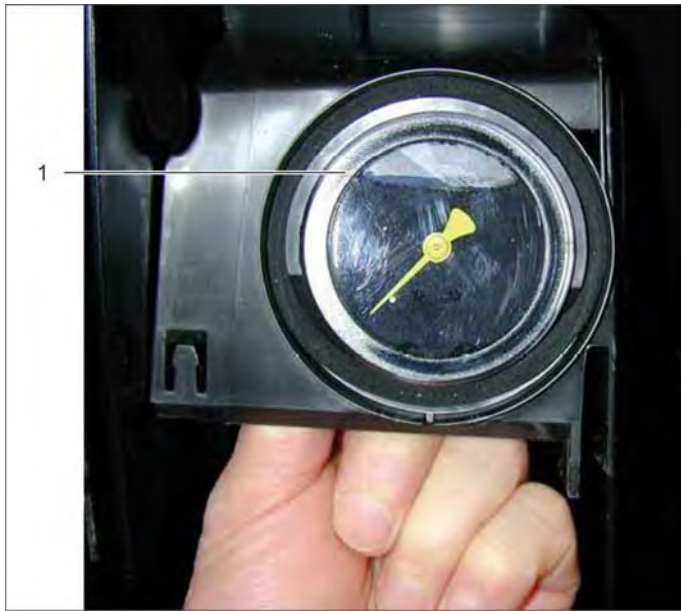

1 Manometer

- Unscrew the screws on the control panel.
- Manually push in the left clip.

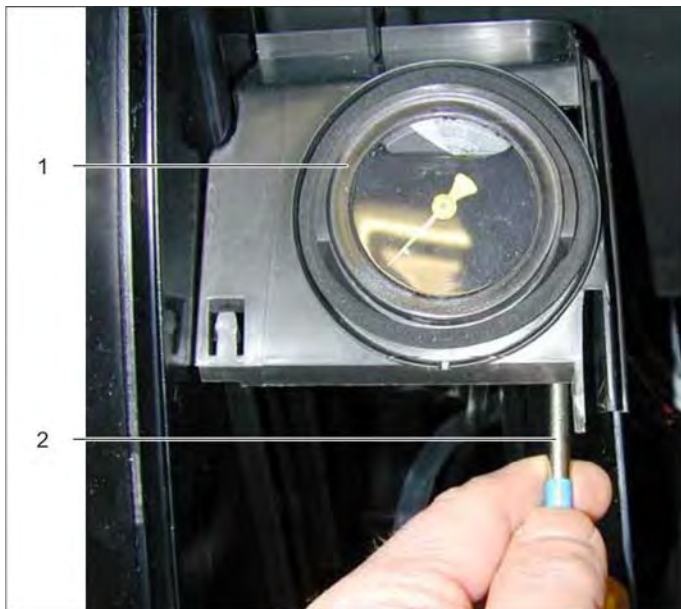

1 Manometer
2 Screwdriver

- Push in the right clip by means of a screwdriver.

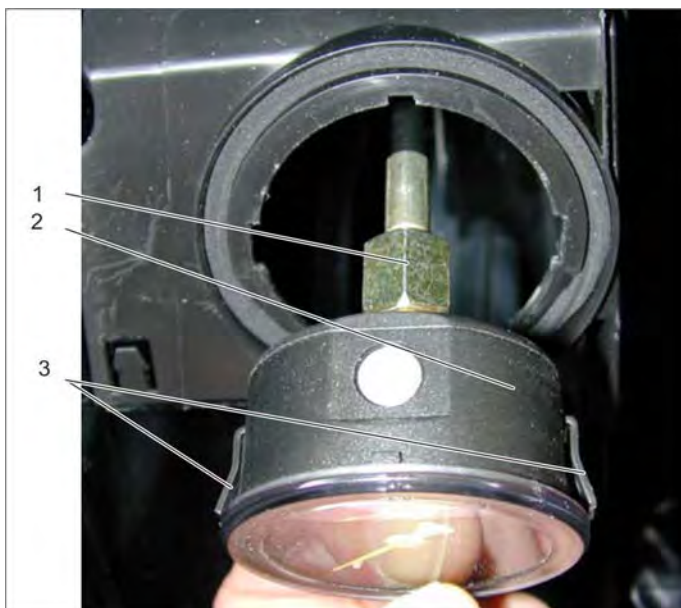

1 Screw connection
2 Manometer
3 Clips

- Remove the pressure gauge.
- Disconnect screw connection.

7.3 Adjust safety valve

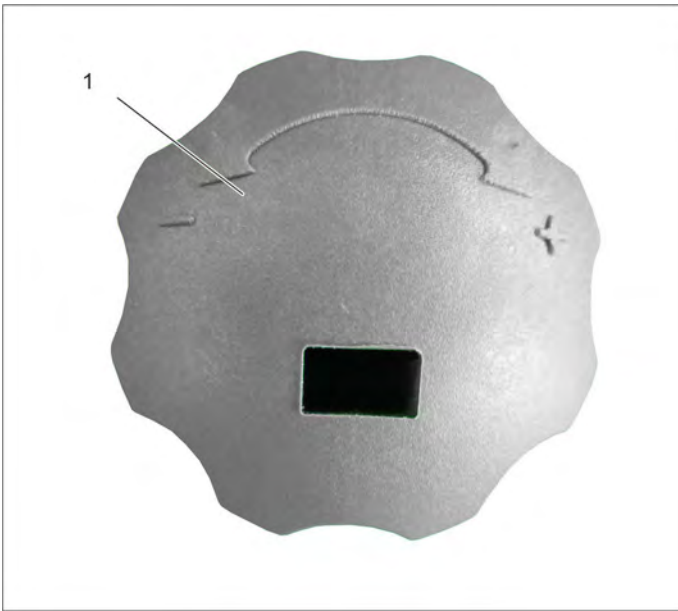

1 Turning handle

- ➔ Screw in the twist grip of the pressure and volume regulation on the pump all the way to the stop (towards "+").
- ➔ Pull off the rotary handle.



1 Adjusting screw
2 Counter-nut

- ➔ Loosen counter-nut.
- ➔ Completely screw in the adjustment screw.
- ➔ Install the stop valve on the high-pressure connection.
- ➔ Turning on the appliance.

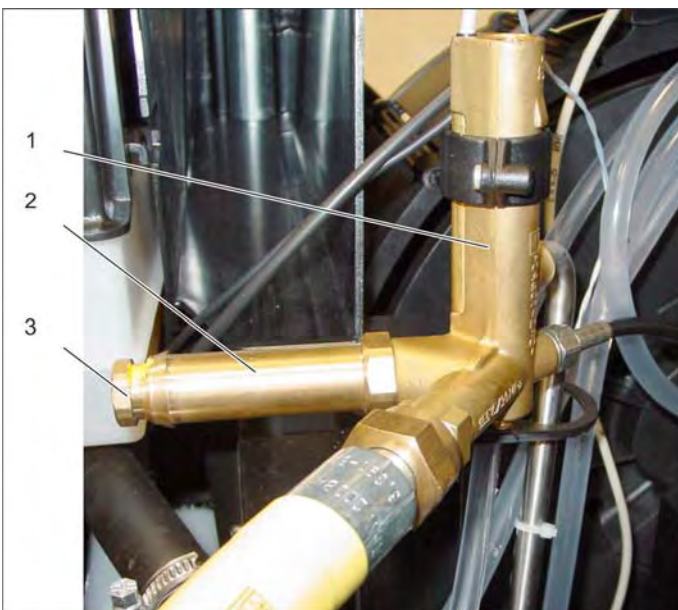

1 Safety block
2 Safety valve
3 Adjustment screw, safety valve

- ➔ Slowly close the stop valve.
- ➔ Observe at what pressure water is tripping. (Nominal value: 20 bar above max. working pressure, see technical data)
- ➔ If the pressure is too high, turn the adjustment screw on the safety valve to the left (relax the pressure spring).
- ➔ If the pressure is too low, turn the adjustment screw on the safety valve to the right (tension the pressure spring).
- ➔ Seal the adjustment screw.
- ➔ Adjust the pressure/ volume regulation.

7.4 Service functions with LED display

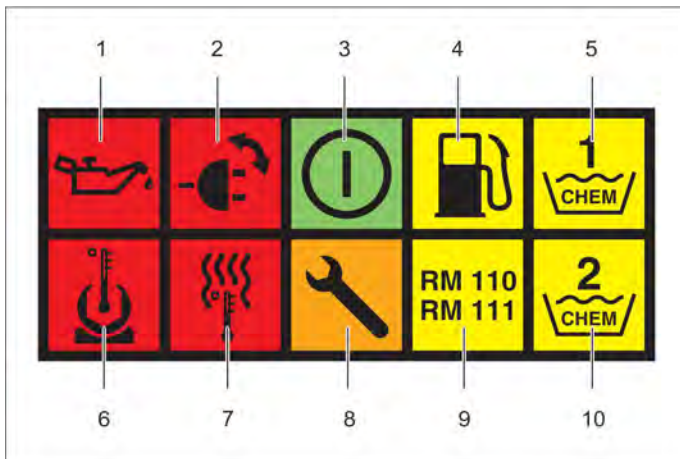

1 Setting, water temperature

Service mode

If the service switch is in the "Service" position (screwdriver symbol) upon switching on the device, the service mode of the device is activated (pump is not running).

Selection of the service functions

The available service functions are selected via the water temperature setting.

Example: 30°C is equivalent to the function „ON30MIN“. For some functions the function selection must already be set upon switching on the device and the service switch must be kept in the "SET" position for 2-3 seconds.

Example: RFIDONOFF is called up with the setting 45 ? (40/-- °C) + "SET" upon switch-on.

- 1 Control LED 0, pump (red)
- 2 Control LED 1, rotation direction (red)
- 3 Control LED 2, operation (green)
- 4 Control LED 3, fuel (yellow)
- 5 Control LED 4, detergent tank 1 (yellow)
- 6 Control LED 5, motor (red)
- 7 Control LED 6, burner (red)
- 8 Control LED 7, service (orange)
- 9 Control LED 8, liquid softener (yellow)
- 10 Control LED 9, detergent tank 2 (yellow)

Changing the settings

The display of the current settings takes place via the 10 indicator LEDs on the control panel. By means of the push-button function of the service switch (continue to turn to "SET" position, switch snaps back to the "Service" position) the settings can be changed. The change is also displayed via the control LEDs.

- 1 Service position
- 2 Service switch





Exiting the service mode

- Turn off the appliance.
- Set the service switch to the appropriate water hardness level or "OFF".
- Turn on the appliance.



Note

For the device versions with a water temperature of max. 80 °C or 60 °C, the temperature settings are indicated in parenthesis (80/60 °C)











7.5 Set up the switching off process

	Function	Adjustments	
		LED indicator	Important
30 °C (30/30 °C)	ON30MIN Behaviour of device after 30 minutes of continuous operation. The setting will be saved.		The device switches off after 30 minutes of continuous operation.
			The device does not switch off after 30 minutes of continuous operation (factory setting).
35 °C (34/32 °C)	OFF30MIN Behaviour of device after 30 minutes of continuous standby operation. The setting will be saved.		The device switches off after 30 minutes in the standby mode.
			The device does not switch off after 30 minutes in the standby mode (factory setting).



7.6 Set up the leakage behaviour

	Function	Adjustments	
		LED indicator	Important
40 °C (37/34 °C)	LECKAGEONOFF Behaviour of the device after 10 short startups of the pump (run time of the pump under 2 seconds). The setting will be saved.		Device switches off after 10 short startups of the pump (factory setting).
			The device does not switch off after 10 short startups of the pump.

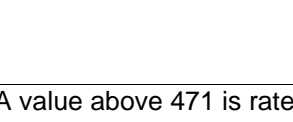





7.7 Brightness value of the flame sensor

	Function	Adjustments	
		LED indicator	Important
45 °C (40/35 °C)	LDRTEST Display of the brightness value measured by the flame sensor. The value is displayed digit by digit by the LEDs, with every LED standing for a numeric value from 0 - 9 in accordance with its number.		Digit value "0"
			Digit value "1"
			Digit value "2"
	The display is repeated after a pause.		Digit value "3"
Example: A brightness value of 1016 is measured. The LEDs light up in the following order:			Digit value "4"
			Digit value "5"
			Digit value "6"
			Digit value "7"
			Digit value "8"
- PAUSE -			Digit value "9"
			
			
A value above 471 is rated as "dark". A value up to 471 is rated as "bright".			











7.8 RFID query











	Function	Adjustments	
		LED indicator	Important
45 °C + „SET“ (40/-- °C + „SET“)	RFIDONOFF Information to the printed circuit board whether the device is equipped with feed via RFID.		Device with RFID Menu access: Select 45°C Switch off device. Hold SET. Turn on the machine. Release SET.
			Device without RFID Check the setting when replacing the printed circuit board.



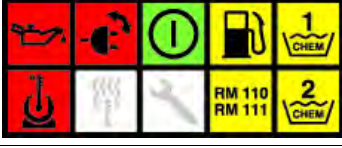

7.9 Testing the temperature sensor

	Function	Adjustments	
		LED indicator	Important
50 °C (43/36 °C)	NTCTEST Display of the water temperature measured by the temperature sensor. The value is shown digit by digit by the LEDs.		Digit value "0"
			Digit value "1"
			Digit value "2"
			Digit value "3"
			Digit value "4"
			Digit value "6"
	
Note At a temperature below 0°, "0" is displayed.			









7.10 Testing the water temperature setting and the programme switch

	Function	Adjustments	
		LED indicator	Important
<p>55 °C (46/38 °C)</p> <p>ENCPROGTEST</p> <p>With this function, the programme switch and the controller for the water temperature setting can be tested.</p> <p>Upon switch-on, all 10 LEDs are on.</p> <p>By operating the push-button function of the service switch (continue to turn to "SET" position and release) and turning the water temperature setting to 30°C, the test is started.</p> <p>If the water temperature setting is gradually increased, the LED display changes as shown to the right.</p>			<p>30 °C (30/30 °C)</p>
			<p>35 °C (34/32 °C)</p>
			<p>40 °C (37/34 °C)</p>
			<p>45 °C (40/35 °C)</p>
			<p>50 °C (43/36 °C)</p>
			<p>55 °C (46/38 °C)</p>
			<p>60 °C (48/40 °C)</p>
			<p>65 °C (50/42 °C)</p>
			<p>70 °C (52/44 °C)</p>
			<p>75 °C (55/45 °C)</p>













Function	Adjustments	
	LED indicator	Important
 55 °C (46/38 °C)		80 °C (58/46 °C)
		85 °C (60/48 °C)
		90 °C (63/50 °C)
		95 °C (66/52 °C)
		100 °C (68/54 °C)
		112 °C (70/55 °C)
		125 °C (74/56 °C)
		140 °C (77/58 °C)
		155 °C (80/60 °C)
		The temperature setting must finally be set back to 55 °C (46/38 °C).

	Function	Adjustments	
 55 °C (46/38 °C)	ENCPROGTEST By operating the pushbutton function of the service switch (continue to turn to "SET" position and release) again, the test for the programme switch is started. The LED display depends on the position of the programme switch now.	LED indicator	Important
			Programme switch position "cold"
			Programme switch position "eco"
	Programme switch position "warm"		
Note To exit the ENCPROGTEST function, switch off the device.			













7.11 Testing the service switch







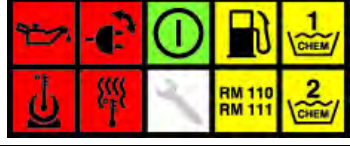

	Function	Adjustments	
		LED indicator	Important
 60 °C (48/40 °C)	ENCDGTTEST Service switch setting display.		Service switch position "OFF"
			Service switch position "1"
			Service switch position "2"
			Service switch position "3"
			Service switch position "4"
			Service switch position "Service"
			Service switch position "SET"

7.12 Testing the sensor













	Function	Adjustments	
65 °C (50/42 °C)		LED indicator	Important
INPUTTEST Use this function to display the status of the different sensors. Every LED displays the status of a certain sensor. Therefore, several LEDs can be on at the same time. Example: 			Lack of oil fuse closed (float up).
This display means: <ul style="list-style-type: none"> - Low oil sensor open (too little oil). - "ON" pressure switch not actuated. - Thermal motor protection switch closed. - Reed switch "fuel tank" closed (tank not empty). - Reed switch "detergent tank 1" open (tank empty). - Reed switch "water shortage safeguard" closed. - "OFF" pressure switch not actuated. - Exhaust gas thermostat open (burner off). - Reed switch "liquid softener tank" closed (float up). - Reed switch "detergent tank 2" open (float up). 			"ON" pressure switch open (pressure switch actuated)
			Thermal motor protection switch closed
			Reed switch "fuel tank" closed (float up)
			Reed switch "detergent tank 1" open (float up)
			Reed switch "water shortage safeguard" closed (water flow present)
			"OFF" pressure switch open (pressure switch actuated)
			Exhaust gas thermostat closed
			Reed switch "liquid softener tank" closed (float up)
			Reed switch "detergent tank 2" open (float up)

7.13 Error memory











	Function	Adjustments	
		LED indicator	Important
 70 °C (52/44 °C)	<p>ERRORS</p> <p>This functions serves to read the fault memory. The faults are displayed in 2 steps:</p> <ol style="list-style-type: none"> 1 LED display of the fault type (see on the right). 2 Display of the pump run time in hours that has passed since the fault had occurred via the numerical values of the LEDs <p>Example:</p>  <p>- PAUSE -</p>   <p>Explanation:</p> <p>The pump has been running for 14 hours since the fault "Thermal motor protection switch open" occurred.</p> <p>Note</p> <p>By operating the pushbutton function on the service switch you can advance to the next fault.</p>	         	<p>Overvoltage detected on transformer 1.</p> <p>Low voltage detected on transformer 1.</p> <p>Excess current detected.</p> <p>Current asymmetry detected.</p> <p>Thermal motor protection switch open.</p> <p>Dry running of the pump detected.</p> <p>"Sticking" water shortage safeguard detected (closed although the pump is off).</p> <p>"Oil refill container empty" detected.</p> <p>Leakage (10 short startups < 2 seconds each).</p> <p>Exhaust thermostat open.</p>

	Function	Adjustments	
 70 °C (52/44 °C)		LED indicator	Important
			Temperature sensor fault. Short circuit or cable break.
			Flame sensor recognises no or not enough light.
			Flame sensor recognises light.
			RFID write-read electronics defective.
	End of the fault memory. Instead of the operating hours, the version of the installed software is displayed here. Example:   Software version 1.4		
Note Every possible fault is saved, indicating how many operating hours ago the relevant fault occurred most recently.			
Note Delete all faults: 70°C (52/44 °C) and hold down "SET" upon switch-on.			

7.14 Operating hours

	Function	Adjustments	
		LED indicator	Important
75 °C (55/45 °C)	STUNDENPWR Indication of the consumed RM 110/111 bottles. The value is displayed digit by digit by the LEDs, with every LED standing for a numeric value from 0 - 9 in accordance with its number.		Digit value "0"
			Digit value "1"
			Digit value "2"
	The display is repeated after a pause.		Digit value "3"
Example: The device has consumed 42 bottles of RM 110/111.			Digit value "4"
			Digit value "4"
			Digit value "5"
			Digit value "6"
			Digit value "7"
			Digit value "8"
			Digit value "9"
- PAUSE -			

7.15 Gun switching operations since gun service

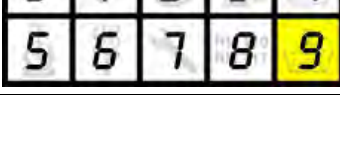









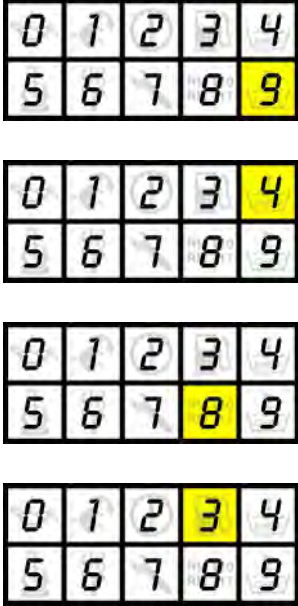

	Function	Adjustments	
		LED indicator	Important
 <p>80 °C (58/46 °C)</p> <p>SI_PISTOLE Display of the gun switchings since the most recent gun service. The value is displayed digit by digit by the LEDs, with every LED standing for a numeric value from 0 - 9 in accordance with its number.</p> <p>The display is repeated after a pause.</p> <p>Example: The gun was actuated 430 times since the last gun service. The LEDs light up in the following order:</p> <p>- PAUSE -</p>			Digit value "0"
			Digit value "1"
			Digit value "2"
			Digit value "3"
			Digit value "4"
			Digit value "5"
			Digit value "6"
			Digit value "7"
			Digit value "8"
			Digit value "9"

7.16 Gun services

	Function	Adjustments																																									
		LED indicator	Important																																								
 <p>85 °C (60/48 °C)</p> <p>SCTR_PISTOLE Display of gun services. The value is displayed digit by digit by the LEDs, with every LED standing for a numeric value from 0 - 9 in accordance with its number.</p> <table border="1" data-bbox="258 571 555 694"> <tr><td>0</td><td>1</td><td>2</td><td>3</td><td>4</td></tr> <tr><td>5</td><td>6</td><td>7</td><td>8</td><td>9</td></tr> </table> <p>The display is repeated after a pause.</p> <p>Example: 11 gun services have been performed since the device was first used. The LEDs light up in the following order:</p> <table border="1" data-bbox="258 1019 555 1142"> <tr><td>0</td><td>1</td><td>2</td><td>3</td><td>4</td></tr> <tr><td>5</td><td>6</td><td>7</td><td>8</td><td>9</td></tr> </table> <table border="1" data-bbox="258 1176 555 1299"> <tr><td>0</td><td>1</td><td>2</td><td>3</td><td>4</td></tr> <tr><td>5</td><td>6</td><td>7</td><td>8</td><td>9</td></tr> </table> <p>- PAUSE -</p>	0	1	2	3	4	5	6	7	8	9	0	1	2	3	4	5	6	7	8	9	0	1	2	3	4	5	6	7	8	9		<table border="1"> <tr><td>0</td><td>1</td><td>2</td><td>3</td><td>4</td></tr> <tr><td>5</td><td>6</td><td>7</td><td>8</td><td>9</td></tr> </table>	0	1	2	3	4	5	6	7	8	9	Digit value "0"
	0	1	2	3	4																																						
	5	6	7	8	9																																						
	0	1	2	3	4																																						
	5	6	7	8	9																																						
	0	1	2	3	4																																						
	5	6	7	8	9																																						
	0	1	2	3	4																																						
	5	6	7	8	9																																						
	<table border="1"> <tr><td>0</td><td>1</td><td>2</td><td>3</td><td>4</td></tr> <tr><td>5</td><td>6</td><td>7</td><td>8</td><td>9</td></tr> </table>	0	1	2	3	4	5	6	7	8	9	Digit value "1"																															
0	1	2	3	4																																							
5	6	7	8	9																																							
<table border="1"> <tr><td>0</td><td>1</td><td>2</td><td>3</td><td>4</td></tr> <tr><td>5</td><td>6</td><td>7</td><td>8</td><td>9</td></tr> </table>	0	1	2	3	4	5	6	7	8	9	Digit value "2"																																
0	1	2	3	4																																							
5	6	7	8	9																																							
<table border="1"> <tr><td>0</td><td>1</td><td>2</td><td>3</td><td>4</td></tr> <tr><td>5</td><td>6</td><td>7</td><td>8</td><td>9</td></tr> </table>	0	1	2	3	4	5	6	7	8	9	Digit value "3"																																
0	1	2	3	4																																							
5	6	7	8	9																																							
<table border="1"> <tr><td>0</td><td>1</td><td>2</td><td>3</td><td>4</td></tr> <tr><td>5</td><td>6</td><td>7</td><td>8</td><td>9</td></tr> </table>	0	1	2	3	4	5	6	7	8	9	Digit value "4"																																
0	1	2	3	4																																							
5	6	7	8	9																																							
<table border="1"> <tr><td>0</td><td>1</td><td>2</td><td>3</td><td>4</td></tr> <tr><td>5</td><td>6</td><td>7</td><td>8</td><td>9</td></tr> </table>	0	1	2	3	4	5	6	7	8	9	Digit value "5"																																
0	1	2	3	4																																							
5	6	7	8	9																																							
<table border="1"> <tr><td>0</td><td>1</td><td>2</td><td>3</td><td>4</td></tr> <tr><td>5</td><td>6</td><td>7</td><td>8</td><td>9</td></tr> </table>	0	1	2	3	4	5	6	7	8	9	Digit value "6"																																
0	1	2	3	4																																							
5	6	7	8	9																																							
<table border="1"> <tr><td>0</td><td>1</td><td>2</td><td>3</td><td>4</td></tr> <tr><td>5</td><td>6</td><td>7</td><td>8</td><td>9</td></tr> </table>	0	1	2	3	4	5	6	7	8	9	Digit value "7"																																
0	1	2	3	4																																							
5	6	7	8	9																																							
<table border="1"> <tr><td>0</td><td>1</td><td>2</td><td>3</td><td>4</td></tr> <tr><td>5</td><td>6</td><td>7</td><td>8</td><td>9</td></tr> </table>	0	1	2	3	4	5	6	7	8	9	Digit value "8"																																
0	1	2	3	4																																							
5	6	7	8	9																																							
<table border="1"> <tr><td>0</td><td>1</td><td>2</td><td>3</td><td>4</td></tr> <tr><td>5</td><td>6</td><td>7</td><td>8</td><td>9</td></tr> </table>	0	1	2	3	4	5	6	7	8	9	Digit value "9"																																
0	1	2	3	4																																							
5	6	7	8	9																																							

	Function	Adjustments	
		LED indicator	Important
 85 °C + „SET“ (60/48 °C + „SET“)	When switching on the device, the gun switching operations since the gun service (SI_PISTOLE) are reset to "0", the service counter gun (SCTR_PISTOLE) is increased by 1 and the fault memory is deleted.		

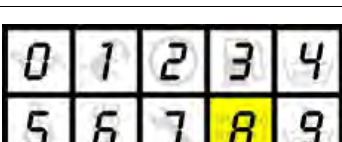
7.17 Gun switches since initial startup

 90°C (63/50 °C)	Function TOTALPISTOLE Display of the gun switchings since device was first started up. The value is displayed digit by digit by the LEDs, with every LED standing for a numeric value from 0 - 9 in accordance with its number.  The display is repeated after a pause. Example: The gun was actuated 9483 times since the device has been put into service. The LEDs light up in the following order:  - PAUSE -	Adjustments	
		LED indicator	Important
		Digit value "0"	
		Digit value "1"	
		Digit value "2"	
		Digit value "3"	
		Digit value "4"	
		Digit value "5"	
		Digit value "6"	
		Digit value "7"	
		Digit value "8"	
		Digit value "9"	

7.18 Operation duration of the burner since burner service

	Function	Adjustments																																									
		LED indicator	Important																																								
 <p>95°C (66/52 °C)</p> <p>SI_Brenner Display of the operation duration of the burner in hours since the last burner service. The value is displayed digit by digit by the LEDs, with every LED standing for a numeric value from 0 - 9 in accordance with its number.</p> <table border="1" data-bbox="258 667 558 788"> <tr><td>0</td><td>1</td><td>2</td><td>3</td><td>4</td></tr> <tr><td>5</td><td>6</td><td>7</td><td>8</td><td>9</td></tr> </table> <p>The display is repeated after a pause.</p> <p>Example: The burner has been in operation for 47 hours since the last burner service. The LEDs light up in the following order:</p> <table border="1" data-bbox="258 1115 558 1236"> <tr><td>0</td><td>1</td><td>2</td><td>3</td><td>4</td></tr> <tr><td>5</td><td>6</td><td>7</td><td>8</td><td>9</td></tr> </table> <table border="1" data-bbox="258 1281 558 1402"> <tr><td>0</td><td>1</td><td>2</td><td>3</td><td>4</td></tr> <tr><td>5</td><td>6</td><td>7</td><td>8</td><td>9</td></tr> </table> <p>- PAUSE -</p>	0	1	2	3	4	5	6	7	8	9	0	1	2	3	4	5	6	7	8	9	0	1	2	3	4	5	6	7	8	9		<table border="1"> <tr><td>0</td><td>1</td><td>2</td><td>3</td><td>4</td></tr> <tr><td>5</td><td>6</td><td>7</td><td>8</td><td>9</td></tr> </table>	0	1	2	3	4	5	6	7	8	9	Digit value "0"
	0	1	2	3	4																																						
	5	6	7	8	9																																						
	0	1	2	3	4																																						
	5	6	7	8	9																																						
	0	1	2	3	4																																						
	5	6	7	8	9																																						
	0	1	2	3	4																																						
	5	6	7	8	9																																						
	<table border="1"> <tr><td>0</td><td>1</td><td>2</td><td>3</td><td>4</td></tr> <tr><td>5</td><td>6</td><td>7</td><td>8</td><td>9</td></tr> </table>	0	1	2	3	4	5	6	7	8	9	Digit value "1"																															
0	1	2	3	4																																							
5	6	7	8	9																																							
<table border="1"> <tr><td>0</td><td>1</td><td>2</td><td>3</td><td>4</td></tr> <tr><td>5</td><td>6</td><td>7</td><td>8</td><td>9</td></tr> </table>	0	1	2	3	4	5	6	7	8	9	Digit value "2"																																
0	1	2	3	4																																							
5	6	7	8	9																																							
<table border="1"> <tr><td>0</td><td>1</td><td>2</td><td>3</td><td>4</td></tr> <tr><td>5</td><td>6</td><td>7</td><td>8</td><td>9</td></tr> </table>	0	1	2	3	4	5	6	7	8	9	Digit value "3"																																
0	1	2	3	4																																							
5	6	7	8	9																																							
<table border="1"> <tr><td>0</td><td>1</td><td>2</td><td>3</td><td>4</td></tr> <tr><td>5</td><td>6</td><td>7</td><td>8</td><td>9</td></tr> </table>	0	1	2	3	4	5	6	7	8	9	Digit value "4"																																
0	1	2	3	4																																							
5	6	7	8	9																																							
<table border="1"> <tr><td>0</td><td>1</td><td>2</td><td>3</td><td>4</td></tr> <tr><td>5</td><td>6</td><td>7</td><td>8</td><td>9</td></tr> </table>	0	1	2	3	4	5	6	7	8	9	Digit value "5"																																
0	1	2	3	4																																							
5	6	7	8	9																																							
<table border="1"> <tr><td>0</td><td>1</td><td>2</td><td>3</td><td>4</td></tr> <tr><td>5</td><td>6</td><td>7</td><td>8</td><td>9</td></tr> </table>	0	1	2	3	4	5	6	7	8	9	Digit value "6"																																
0	1	2	3	4																																							
5	6	7	8	9																																							
<table border="1"> <tr><td>0</td><td>1</td><td>2</td><td>3</td><td>4</td></tr> <tr><td>5</td><td>6</td><td>7</td><td>8</td><td>9</td></tr> </table>	0	1	2	3	4	5	6	7	8	9	Digit value "7"																																
0	1	2	3	4																																							
5	6	7	8	9																																							
<table border="1"> <tr><td>0</td><td>1</td><td>2</td><td>3</td><td>4</td></tr> <tr><td>5</td><td>6</td><td>7</td><td>8</td><td>9</td></tr> </table>	0	1	2	3	4	5	6	7	8	9	Digit value "8"																																
0	1	2	3	4																																							
5	6	7	8	9																																							
<table border="1"> <tr><td>0</td><td>1</td><td>2</td><td>3</td><td>4</td></tr> <tr><td>5</td><td>6</td><td>7</td><td>8</td><td>9</td></tr> </table>	0	1	2	3	4	5	6	7	8	9	Digit value "9"																																
0	1	2	3	4																																							
5	6	7	8	9																																							

7.19 Burner service















	Function	Adjustments																															
		LED indicator	Important																														
 <p>100°C (68/54 °C)</p> <p>SCTR_BRENNER Display of the burner service. The value is displayed digit by digit by the LEDs, with every LED standing for a numeric value from 0 - 9 in accordance with its number.</p> <table border="1" data-bbox="258 609 555 725"> <tr><td>0</td><td>1</td><td>2</td><td>3</td><td>4</td></tr> <tr><td>5</td><td>6</td><td>7</td><td>8</td><td>9</td></tr> </table> <p>The display is repeated after a pause.</p> <p>Example: 4 burner services have been performed since the device was first used. The LEDs light up in the following order:</p> <table border="1" data-bbox="258 1057 555 1173"> <tr><td>0</td><td>1</td><td>2</td><td>3</td><td>4</td></tr> <tr><td>5</td><td>6</td><td>7</td><td>8</td><td>9</td></tr> </table> <p>- PAUSE -</p>	0	1	2	3	4	5	6	7	8	9	0	1	2	3	4	5	6	7	8	9		<table border="1"> <tr><td>0</td><td>1</td><td>2</td><td>3</td><td>4</td></tr> <tr><td>5</td><td>6</td><td>7</td><td>8</td><td>9</td></tr> </table>	0	1	2	3	4	5	6	7	8	9	Digit value "0"
	0	1	2	3	4																												
	5	6	7	8	9																												
	0	1	2	3	4																												
	5	6	7	8	9																												
	0	1	2	3	4																												
	5	6	7	8	9																												
	<table border="1"> <tr><td>0</td><td>1</td><td>2</td><td>3</td><td>4</td></tr> <tr><td>5</td><td>6</td><td>7</td><td>8</td><td>9</td></tr> </table>	0	1	2	3	4	5	6	7	8	9	Digit value "1"																					
	0	1	2	3	4																												
	5	6	7	8	9																												
<table border="1"> <tr><td>0</td><td>1</td><td>2</td><td>3</td><td>4</td></tr> <tr><td>5</td><td>6</td><td>7</td><td>8</td><td>9</td></tr> </table>	0	1	2	3	4	5	6	7	8	9	Digit value "2"																						
0	1	2	3	4																													
5	6	7	8	9																													
<table border="1"> <tr><td>0</td><td>1</td><td>2</td><td>3</td><td>4</td></tr> <tr><td>5</td><td>6</td><td>7</td><td>8</td><td>9</td></tr> </table>	0	1	2	3	4	5	6	7	8	9	Digit value "3"																						
0	1	2	3	4																													
5	6	7	8	9																													
<table border="1"> <tr><td>0</td><td>1</td><td>2</td><td>3</td><td>4</td></tr> <tr><td>5</td><td>6</td><td>7</td><td>8</td><td>9</td></tr> </table>	0	1	2	3	4	5	6	7	8	9	Digit value "4"																						
0	1	2	3	4																													
5	6	7	8	9																													
<table border="1"> <tr><td>0</td><td>1</td><td>2</td><td>3</td><td>4</td></tr> <tr><td>5</td><td>6</td><td>7</td><td>8</td><td>9</td></tr> </table>	0	1	2	3	4	5	6	7	8	9	Digit value "5"																						
0	1	2	3	4																													
5	6	7	8	9																													
<table border="1"> <tr><td>0</td><td>1</td><td>2</td><td>3</td><td>4</td></tr> <tr><td>5</td><td>6</td><td>7</td><td>8</td><td>9</td></tr> </table>	0	1	2	3	4	5	6	7	8	9	Digit value "6"																						
0	1	2	3	4																													
5	6	7	8	9																													
<table border="1"> <tr><td>0</td><td>1</td><td>2</td><td>3</td><td>4</td></tr> <tr><td>5</td><td>6</td><td>7</td><td>8</td><td>9</td></tr> </table>	0	1	2	3	4	5	6	7	8	9	Digit value "7"																						
0	1	2	3	4																													
5	6	7	8	9																													
<table border="1"> <tr><td>0</td><td>1</td><td>2</td><td>3</td><td>4</td></tr> <tr><td>5</td><td>6</td><td>7</td><td>8</td><td>9</td></tr> </table>	0	1	2	3	4	5	6	7	8	9	Digit value "8"																						
0	1	2	3	4																													
5	6	7	8	9																													
<table border="1"> <tr><td>0</td><td>1</td><td>2</td><td>3</td><td>4</td></tr> <tr><td>5</td><td>6</td><td>7</td><td>8</td><td>9</td></tr> </table>	0	1	2	3	4	5	6	7	8	9	Digit value "9"																						
0	1	2	3	4																													
5	6	7	8	9																													

	Function	Adjustments	
		LED indicator	Important
 100°C + „SET“ (68/54 °C + „SET“)	When switching on the device, the burner operation duration since the burner service (SI_BRENNER) is reset to "0", the service counter burner (SCTR_BRENNER) is increased by 1 and the fault memory is deleted.		











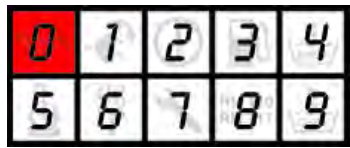

7.20 Burner operation since initial startup

	Function	Adjustments																																									
		LED indicator	Important																																								
 <p>112°C (70/55 °C)</p> <p>TOTALBRENNER Display of the operation duration of the burner in hours since the initial startup of the device. The value is displayed digit by digit by the LEDs, with every LED standing for a numeric value from 0 - 9 in accordance with its number.</p> <table border="1" data-bbox="258 667 555 788"> <tr><td>0</td><td>1</td><td>2</td><td>3</td><td>4</td></tr> <tr><td>5</td><td>6</td><td>7</td><td>8</td><td>9</td></tr> </table> <p>The display is repeated after a pause.</p> <p>Example: The burner has been in operation for 32 hours since the initial startup of the device. The LEDs light up in the following order:</p> <table border="1" data-bbox="258 1115 555 1236"> <tr><td>0</td><td>1</td><td>2</td><td>3</td><td>4</td></tr> <tr><td>5</td><td>6</td><td>7</td><td>8</td><td>9</td></tr> </table> <table border="1" data-bbox="258 1281 555 1402"> <tr><td>0</td><td>1</td><td>2</td><td>3</td><td>4</td></tr> <tr><td>5</td><td>6</td><td>7</td><td>8</td><td>9</td></tr> </table> <p>- PAUSE -</p>	0	1	2	3	4	5	6	7	8	9	0	1	2	3	4	5	6	7	8	9	0	1	2	3	4	5	6	7	8	9		<table border="1"> <tr><td>0</td><td>1</td><td>2</td><td>3</td><td>4</td></tr> <tr><td>5</td><td>6</td><td>7</td><td>8</td><td>9</td></tr> </table>	0	1	2	3	4	5	6	7	8	9	Digit value "0"
	0	1	2	3	4																																						
	5	6	7	8	9																																						
	0	1	2	3	4																																						
	5	6	7	8	9																																						
	0	1	2	3	4																																						
	5	6	7	8	9																																						
	0	1	2	3	4																																						
	5	6	7	8	9																																						
	<table border="1"> <tr><td>0</td><td>1</td><td>2</td><td>3</td><td>4</td></tr> <tr><td>5</td><td>6</td><td>7</td><td>8</td><td>9</td></tr> </table>	0	1	2	3	4	5	6	7	8	9	Digit value "1"																															
0	1	2	3	4																																							
5	6	7	8	9																																							
<table border="1"> <tr><td>0</td><td>1</td><td>2</td><td>3</td><td>4</td></tr> <tr><td>5</td><td>6</td><td>7</td><td>8</td><td>9</td></tr> </table>	0	1	2	3	4	5	6	7	8	9	Digit value "2"																																
0	1	2	3	4																																							
5	6	7	8	9																																							
<table border="1"> <tr><td>0</td><td>1</td><td>2</td><td>3</td><td>4</td></tr> <tr><td>5</td><td>6</td><td>7</td><td>8</td><td>9</td></tr> </table>	0	1	2	3	4	5	6	7	8	9	Digit value "3"																																
0	1	2	3	4																																							
5	6	7	8	9																																							
<table border="1"> <tr><td>0</td><td>1</td><td>2</td><td>3</td><td>4</td></tr> <tr><td>5</td><td>6</td><td>7</td><td>8</td><td>9</td></tr> </table>	0	1	2	3	4	5	6	7	8	9	Digit value "4"																																
0	1	2	3	4																																							
5	6	7	8	9																																							
<table border="1"> <tr><td>0</td><td>1</td><td>2</td><td>3</td><td>4</td></tr> <tr><td>5</td><td>6</td><td>7</td><td>8</td><td>9</td></tr> </table>	0	1	2	3	4	5	6	7	8	9	Digit value "5"																																
0	1	2	3	4																																							
5	6	7	8	9																																							
<table border="1"> <tr><td>0</td><td>1</td><td>2</td><td>3</td><td>4</td></tr> <tr><td>5</td><td>6</td><td>7</td><td>8</td><td>9</td></tr> </table>	0	1	2	3	4	5	6	7	8	9	Digit value "6"																																
0	1	2	3	4																																							
5	6	7	8	9																																							
<table border="1"> <tr><td>0</td><td>1</td><td>2</td><td>3</td><td>4</td></tr> <tr><td>5</td><td>6</td><td>7</td><td>8</td><td>9</td></tr> </table>	0	1	2	3	4	5	6	7	8	9	Digit value "7"																																
0	1	2	3	4																																							
5	6	7	8	9																																							
<table border="1"> <tr><td>0</td><td>1</td><td>2</td><td>3</td><td>4</td></tr> <tr><td>5</td><td>6</td><td>7</td><td>8</td><td>9</td></tr> </table>	0	1	2	3	4	5	6	7	8	9	Digit value "8"																																
0	1	2	3	4																																							
5	6	7	8	9																																							
<table border="1"> <tr><td>0</td><td>1</td><td>2</td><td>3</td><td>4</td></tr> <tr><td>5</td><td>6</td><td>7</td><td>8</td><td>9</td></tr> </table>	0	1	2	3	4	5	6	7	8	9	Digit value "9"																																
0	1	2	3	4																																							
5	6	7	8	9																																							

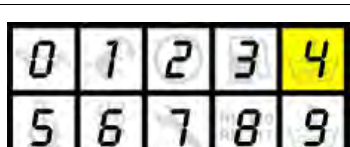
7.21 Operating hours of the pump since pump service











	Function	Adjustments	
 125°C (74/56 °C)	SI_PUMPE Display of the operating time of the pump since the last pump service in hours. The value is displayed digit by digit by the LEDs, with every LED standing for a numeric value from 0 - 9 in accordance with its number.  The display is repeated after a pause. Example: The burner has been in operation for 31 hours since the initial startup of the device. The LEDs light up in the following order:   - PAUSE -	LED indicator	Important
			Digit value "0"
			Digit value "1"
			Digit value "2"
			Digit value "3"
			Digit value "4"
			Digit value "5"
			Digit value "6"
			Digit value "7"
			Digit value "8"
			Digit value "9"

7.22 Pump service

	Function	Adjustments	
		LED indicator	Important
 140°C (77/58 °C)	<p>SCTR_PUMPE Display of the pump services. The value is displayed digit by digit by the LEDs, with every LED standing for a numeric value from 0 - 9 in accordance with its number.</p>  <p>The display is repeated after a pause.</p> <p>Example: 7 pump services have been performed since the device was first used. The LEDs light up in the following order:</p>  <p>- PAUSE -</p>		Digit value "0"
			Digit value "1"
			Digit value "2"
			Digit value "3"
			Digit value "4"
			Digit value "5"
			Digit value "6"
			Digit value "7"
			Digit value "8"
			Digit value "9"

	Function	Adjustments	
		LED indicator	Important
 140°C + „SET“ (77/58 °C + „SET“)	When switching on the device, the pump operation duration since the pump service (SI_PUMPE) is reset to "0", the service counter pump (SCTR_PUMPE) is increased by 1 and the fault memory is deleted.		

7.23 Pump operation since initial startup

	Function	Adjustments	
		LED indicator	Important
155°C (80/60 °C)	TOTALPUMPE Display of the operating time of the pump since the initial device startup in hours. The value is displayed digit by digit by the LEDs, with every LED standing for a numeric value from 0 - 9 in accordance with its number.		Digit value "0"
			Digit value "1"
			Digit value "2"
			Digit value "3"
			Digit value "4"
			Digit value "5"
			Digit value "6"
			Digit value "7"
			Digit value "8"
			Digit value "9"
- PAUSE -			

7.24 Servicefunktionen mit Displayanzeige



1 Setting, water temperature

Service mode

If the service switch is in the "Service" position (screwdriver symbol) upon switching on the device, the service mode of the device is activated (pump is not running).

Selection of the service functions

The available service functions are selected via the water temperature setting.

Example: 30°C is equivalent to the function "Switch-off after 30 minutes of continuous operation".

For some functions the function selection must already be set upon switching on the device and the service switch must be kept in the "SET" position for 2-3 seconds.

Example: "RFID recognition" is called up with the setting 45°C + "SET" upon switch-on.



1 Display

Changing the settings

The indication of the current setting takes place via the display on the control panel.

By means of the pushbutton function of the service switch (continue to turn to "SET" position, switch snaps back to the "Service" position) the settings can be changed. The change is also shown on the display.

Exiting the service mode





- Turn off the appliance.
- Set the service switch to the appropriate water hardness level or "OFF".
- Turn on the appliance.





1 Service position

2 Service switch





7.25 Set up the switching off process

	Display	Explanation	Remark
30°C	 SERVICE	Switch-off after 30 minutes of continuous operation is activated.	Switching with SET
	 SERVICE	Switch-off after 30 minutes of continuous operation is not activated (factory setting).	Switching with SET
35°C	 SERVICE	Switch-off after 30 minutes of continuous break is activated.	Switching with SET
	 SERVICE	Switch-off after 30 minutes of continuous break is not activated (factory setting).	Switching with SET



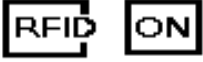

7.26 Set up the leakage behaviour

	Display	Explanation	Remark
40°C	 SERVICE	Switch-off after 10 short startups activated (factory setting).	Switching with SET
	 SERVICE	Switch-off after 10 short startups is not activated.	Switching with SET





7.27 RFID query

	Display	Explanation	Remark
45°C + „SET“	 	Device is equipped with RFID.	Menu access: Select 45°C Switch off device. Hold SET. Turn on the machine. Release SET. Select settings with SET.
	 	Device is not equipped with RFID. Check the setting when replacing the printed circuit board.	Menu access: Select 45°C Switch off device. Hold SET. Turn on the machine. Release SET. Select settings with SET.







7.28 Brightness value of the flame sensor

	Display	Explanation	Remark
45°C	  1023 	Test flame sensor. Display brightness value.	<471: bright >=471: dark



7.29 Testing the temperature sensor

	Display	Explanation	Remark
50°C	  18°C 	Test temperature sensor Indication temperature.	0°C is displayed when the temperature is below 0°C.



7.30 Testing the water temperature setting and the programme switch

	Display	Explanation	Remark
55°C		Output image for temperature selector switch test.	Use SET to access the temperature selector switch test.
		Temperaturwahlschaltestest. Es wird die am Temperaturwahlschalter gewählte Temperatur angezeigt.	Wenn der Temperaturwahlschaltestest fertig ist, muss wieder 55°C gewählt werden. Mit SET gelangt man in den Hauptschaltestest
		Main switch test	
		Main switch test	
		Main switch test	
		Main switch test	This display appears only very briefly as the device is also switched off here.

7.31 Test service switch



















	Display	Explanation	Remark
60°C		Selected liquid softener setting.	







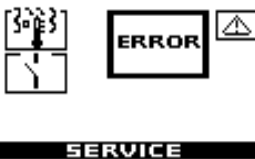

7.32 Testing the sensors

	Display	Explanation	Remark
65°C		Description from left to right: Level stage fuel sensor (stage 7 of 8) Thermal motor protection switch open. Oil refill container not empty Exhaust thermostat open. Water shortage safeguard open Level stage detergent 1 (stage 1 of 4) Liquid softener container is empty On pressure switch pressed Off pressure switch pressed Level stage detergent 2 (stage 2 of 4)	In case of a cable break with a level sensor no stage is displayed.
		Description from left to right: Level stage fuel sensor (stage 7 of 8) Thermal motor protection switch closed Oil refill container not empty Exhaust gas thermostat closed Water shortage safeguard closed Level stage detergent 1 (stage 1 of 4) Liquid softener container is full On pressure switch not pressed Off pressure switch not pressed Level stage detergent 2 (stage 2 of 4)	If a level sensor has a cable break, no stage is displayed.



7.33 Error memory

Note Use SET to switch over to the next fault. With switch-off - hold SET - switch-on the fault memory can be deleted.





 70°C	Display	Explanation	Remark
	 	Mains voltage too high	Check the supply voltage.
	 	Mains voltage too low	Check the supply voltage.
	 	Motor current too high	Motor sluggish or phase failed. Check the mains connection.
	 	Motor asymmetric	Phase failed. Check the mains connection.
	 	Thermal motor protection switch open.	Engine is overheated Motor sluggish. Check the mains connection.
	 	Dry running of the pump (2 minutes)	Ensure water supply. Check water shortage safe guard.
	 	Water shortage safeguard is sticky (reed switch or magnetic piston)	Check water shortage safe guard.
	 	Oil refill container empty	Refill lubricating oil. Check the float of the oil refill container.
	 	10 short startups took place due to leakage	Rectify leaks in the high-pressure system.

	Display	Explanation	Remark
		Exhaust thermostat has triggered.	Decarbonize boiler. Check exhaust gas thermostat.
		Cable break or short circuit with water temperature sensor	Check temperature sensor.
		Flame sensor does not detect a flame although the burner was switched on	Clean the looking glass. Check fuel supply.
		The flame sensor recognised bright although the burner was off	Incidence of secondary light at the flame sensor. Combustion chamber scaled. Solenoid valve does not close.
		RFID write-read electronics defective.	RFID write-read electronics is defective - replace.
		Cable break with level sensor fuel occurred	Check level sensor fuel.
		Cable break with level sensor detergent tank 1 occurred	Check level sensor RM 1.
		Cable break with level sensor detergent tank 2 occurred	Check level sensor RM 2.
		Software version 1.1	This is no fault. Error merely appears for design reasons, because the display is in the error menu.



7.34 Operating hours

	Display	Explanation	Remark
75°C	  544 SERVICE	Indication of the consumed RM 110/111 bottles.	



7.35 Gun switching operations since gun service

	Display	Explanation	Remark
80°C	   22 589 SERVICE	Number of gun switching operations since the last maintenance	Maintenance after 80000 gun switching operations





7.36 Gun services

	Display	Explanation	Remark
85°C	  4 SERVICE	Number of gun maintenances	Delete service. Turn off the appliance. Hold SET (2-3 seconds). Turn on the appliance. Note The fault memory is also deleted.



7.37 Gun services since initial startup

	Display	Explanation	Remark
90°C	  322 589 SERVICE	Number of total gun switching operations	



7.38 Operation duration of the burner since startup

	Display	Explanation	Remark
95°C	   112h SERVICE	Operation duration burner since the last maintenance	Maintenance after 400 burner hours.





7.39 Burner service

	Display	Explanation	Remark
100°C	  1 SERVICE	Number of burner maintenances	Delete service. Turn off the appliance. Hold SET (2-3 seconds). Turn on the appliance. Note The fault memory is also deleted.



7.40 Burner operation since initial startup

	Display	Explanation	Remark
112°C	  512h SERVICE	Total operation duration burner	



7.41 Operating hours of the pump since pump service

	Display	Explanation	Remark
125°C	   11h SERVICE	Operation duration pump since the last maintenance	Maintenance after 600 pump hours.

7.42 Pump services

	Display	Explanation	Remark
140°C	  2 SERVICE	Number of pump maintenances	Delete service. Turn off the appliance. Hold SET (2-3 seconds). Turn on the appliance. Note The fault memory is also deleted.

7.43 Pump operation since initial startup

	Display	Explanation	Remark
155°C	  1 211h SERVICE	Total operation duration of the pump	

7.44 Quick overview for reading the service functions

- Turn off the appliance.
- Make a note of the position of the service switch.
- Set the service switch to Service.
- Turn on the appliance.
- Set temperature regulator to the relevant temperature.
- 30 (30/20)°C - Behaviour after 30 minutes of continuous operation.
- 35 (34/32)°C - Behaviour after 30 minutes of stand-by.
- 40 (37/34)°C - Behaviour in case of leakage.
- 45 (40/35)°C - Brightness flame sensor.
- 45 (40/35)°C and Set upon switch-on - device with/without RFID
- 50 (43/36)°C - Temperature at the temperature sensor.
- 55 (46/38)°C - Function check programme switch and temperature controller.
- 60 (48/40)°C - Function check service switch.
- 65 (50/42)°C - Input test (level oil pump, pressure switch ON, winding protection motor, level fuel, level chem1, water shortage safeguard, pressure switch OFF, exhaust gas thermostat, level system care, level chem2).
- 70 (52/44)°C - Display fault memory and software function (overvoltage, low voltage, excess current, phases asymmetric, winding protection motor, dry running, water shortage safeguard is stuck, oil shortage pump, leakage, exhaust gas thermostat, temperature sensor, flame sensor without light, flame sensor with light, RFID defective, software version).
- 75 (55/45)°C - Bottle consumption system care RM 110/111.
- 80 (58/46)°C - Gun switching operations since the last gun service (maintenance every 80000 switching operations).
- 85 (60/48)°C - Number of gun services.
- 85 (60/48)°C and Set upon switch-on - delete gun service and fault memory.
- 90 (63/50)°C - Total gun switching operations.
- 95 (66/52)°C - Operating hours since last burner service (maintenance every 400 h).
- 100 (68/54)°C - Number of burner services.
- 100 (68/54)°C and Set upon switch-on - delete burner service and fault memory.
- 112 (70/55)°C - Total operating hours burner.
- 125 (74/56)°C - Operating hours since last pump service (maintenance every 600 h).
- 140 (77/58)°C - Number of pump services.
- 140 (77/58)°C and Set upon switch-on - delete pump service and fault memory.
- 155 (80/60)°C - Total operating hours pump.
- Turn off the appliance.
- Bring the service switch back into the position taken down before.
- Turn on the appliance.

Note

- 1. Value without brackets concerns all standard devices.
- 1. Value in brackets for devices up to max. 80 ?.
- 2. Value in brackets for devices up to max. 60 ?.

7.45 Reset of the maintenances

Display "Service" is on and the device functions completely normal.

- Description applies to HDS devices with indicator lights on the control panel.
- When resetting the maintenances, the fault memory is also deleted. (Delete faults only: Temperature controller to 70 (52/44)°C and SET upon switch-on).

Maintenance due as one or several of the following conditions has been reached:

- 80000 gun switching operations,
- 400 burner hours or
- 600 pump hours.

- Print and cut out template (page 13).
- Hold the template against the indicator lights on the control panel.

- Select the service mode.
(Switch off the device, put the service switch to "Service", switch on device).

Query gun switching operations: Temperature controller to 80 (58/46)°C.

- Maintenance is due after 80000 switching operations.
- Perform maintenance when necessary.
- Reset gun maintenance: 85 (60/48)°C and hold SET upon switch-on.

Query burner hours: Temperature controller to 95 (66/52)°C.

- Maintenance is due at 400h.
- Perform maintenance when necessary.
- Reset burner maintenance: 100 (68/54)°C and hold SET upon switch-on.

Query pump hours: Temperature controller to 125 (74/56)°C.

- Maintenance is due at 600h.
- Perform maintenance when necessary.
- Reset pump maintenance: 140 (77/58)°C and hold SET upon switch-on.

Note

- 1. Value without brackets concerns all standard devices.
- 1. Value in brackets for devices up to max. 80 ?.
- 2. Value in brackets for devices up to max. 60 ?.

7.46 Overview of a quick check of the device status

Read the fault memory in service mode at 70 (52/44)°C. Advance with "SET".
Every fault type is saved only once, together with the passed hours since it has last occurred.

X0000 00000	Overvoltage detected hours ago:
0X000 00000	Low voltage range detected hours ago:
00X00 00000	Excess current detected hours ago:
000X0 00000	Current asymmetry detected hours ago:
0000X 00000	Tripped winding protection motor detected hours ago:
00000 0000X	2 minutes dry running detected hours ago:
00000 000X0	Stuck water shortage safeguard detected hours ago:
00000 00X00	Oil shortage in pump detected hours ago:
00000 0X000	Leakage (10 short startups) detected hours ago:
00000 X0000	Triggered exhaust gas thermostat detected hours ago:
XX000 00000	Faulty temperature sensor for water detected in hours:
0XX00 00000	Flame sensor detects too little light hours ago:
00XX0 00000	Flame sensor detects light hours ago:
000XX 00000	Reading error RFID electronics detected hours ago:

0000 end of the fault memory reached.

0000 display of the software version.

7.47 Settings, burner

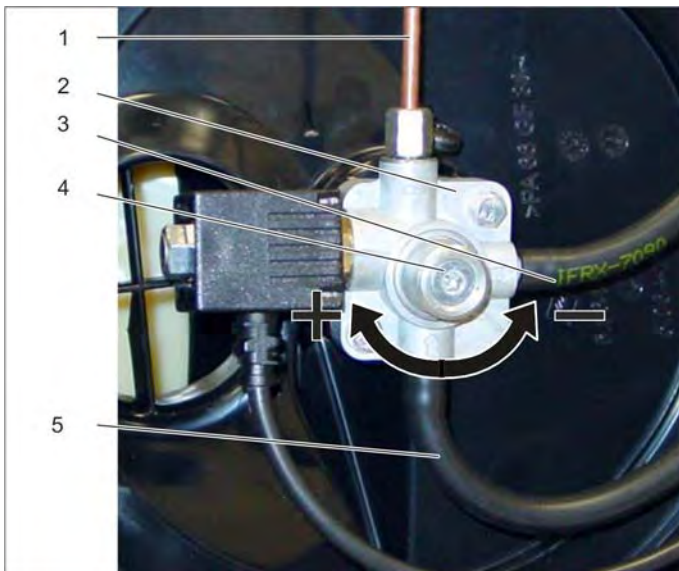

- 1 Pressure line to the burner
- 2 Fuel pump
- 3 Suction hose, fuel
- 4 Adjustment screw, fuel pressure
- 5 Return hose to the fuel tank

Measure water temperature

- ➔ Install the shut-off valve with thermometer (special tool) on the appliance outlet.
- ➔ Switch on the burner and bring the appliance to working pressure with full water volume via the shut-off valve.
- ➔ Let the device run in burner operation for approx. 5 minutes until the maximum water temperature is reached.
- ➔ Measure the increase in water temperature (water outlet temperature minus water supply flow temperature).
- ➔ For target values refer to technical specifications.
- ➔ Measure the soot value, CO₂ content and the exhaust temperature (special tools, measuring gauges).

- 1 Air door, air volume adjustment
- 2 Stop screw

Adjusting the fuel pressure

- ➔ Set the fuel pressure (and water temperature) via the set screw.
- ➔ For target values refer to technical specifications.

Adjusting the soot value

- ➔ If the soot value is too high, then the air flap needs to be opened further or the fuel pressure needs to be reduced.

Adjust the CO₂ value

- ➔ Adjust the CO₂ value by moving the air flap. Open the air flap, the CO₂ content is decreasing.

Note

An accurate basic adjustment of the burner is only possible if the heating coil was previously thoroughly desooted and the deposits were removed. Eine exakte Grundeinstellung des Brenners ist nur möglich, wenn die Heizschlange vorher gründlich entrußt und die inneren Ablagerungen entfernt wurden.

Note

After finishing the basic adjustment, the fuel pump and the air flap must be sealed.

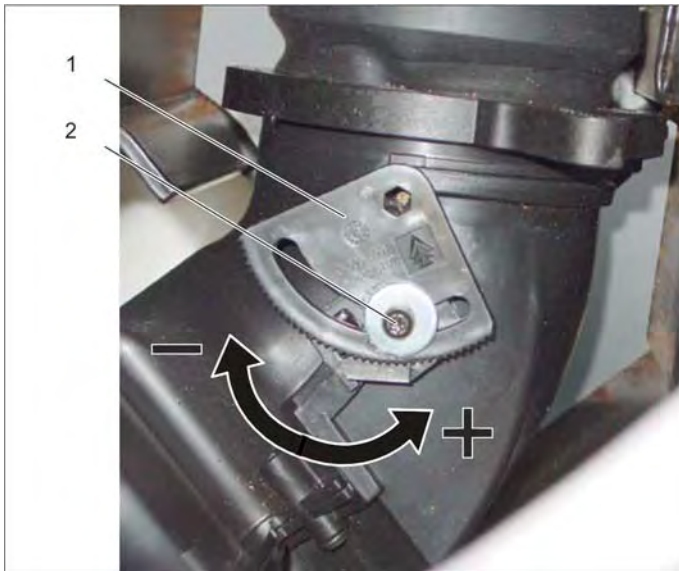

7.48 Installation air duct on the outer jacket

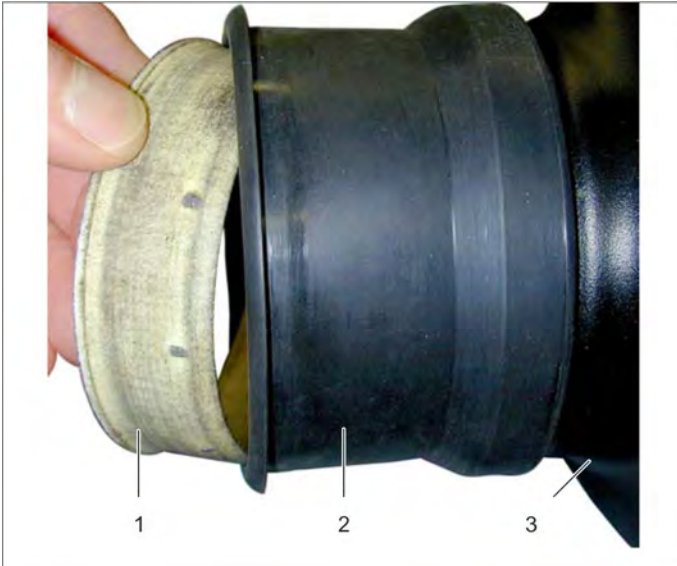

- 1 Clamp ring
- 2 Air guidance
- 3 Exterior coat

- ➔ Clean the air duct and the outer jacket in the installation area.
- ➔ Install the air duct on the outer jacket.
- ➔ Grease clamping ring.
- ➔ Insert the clamping ring up into the air duct up to the noticeable stop.

Note

When installing the outer jacket (booster heater) in the device, the air duct can fall off the outer jacket. This leads to an aggravated installation. An additional clamping ring serves as installation aid.

Note

Ensure correct seating of the air duct.



- 1 Lock handles
- 2 Exterior coat
- 3 Clamp ring
- 4 Air guidance

7.49 Adjusting the working pressure with the rotary regulator on the gun

7.49.1 Setting the maximum working pressure

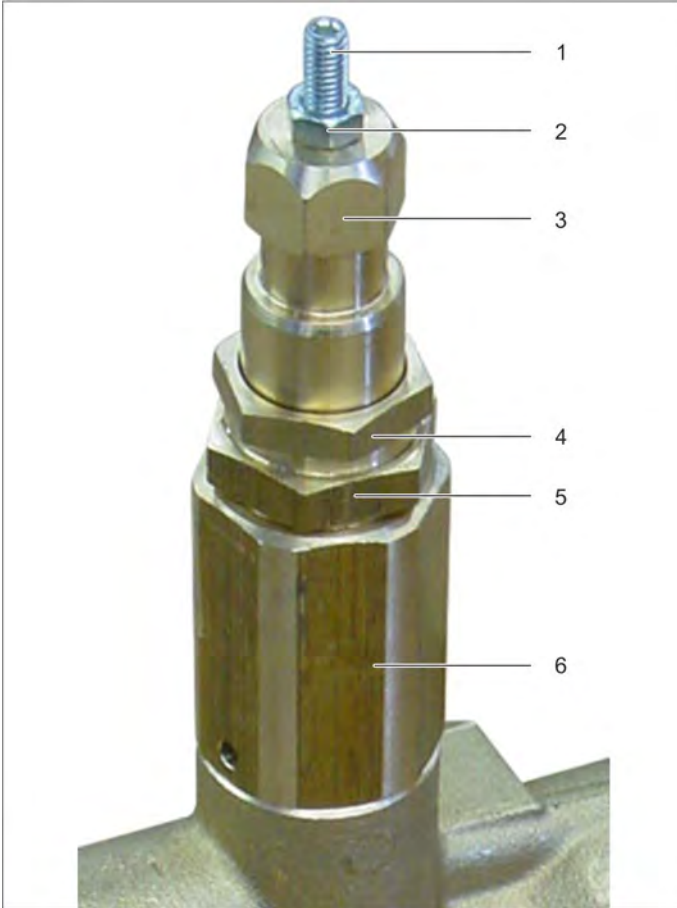

- 1 Adjustment screw, high pressure
- 2 Lock nut, adjustment screw, high pressure
- 3 Spindle, pressure and quantity regulation
- 4 Adjustment screw, low pressure
- 5 Lock nut, adjustment screw, low pressure
- 6 Housing, overflow valve

- Install the test manometer (special tool) to the high-pressure connection.
- Connect the high-pressure hose with gun and rotary regulator to the test manometer.
- Screw in the twist grip of the pressure and volume regulation on the pump all the way to the stop (towards "+").
- Turn the rotary regulator to the position with the lowest pressure at the nozzle (towards "-"), open gun and let the device run.
- Pull off the rotary handle.
- Loosen the locknut of the adjustment screw for high pressure.
- Turn the adjustment screw high pressure in a way that the opening pressure of the overflow valve is reached on the test manometer.

Note

If this screw is turned clockwise, the pressure is increased; and if it is turned counter-clockwise, the pressure is decreased.

- After adjustment, secure the adjustment screw high pressure by means of a lock nut.
- Check the working pressure, feed volume and switch points of the pressure switches.
- Seal the adjustment screw for high pressure and the lock nut with safety lacquer.

Note

The rotary regulator is used to adjust the opening pressure of the overflow valve.

7.49.2 Setting the minimum working pressure

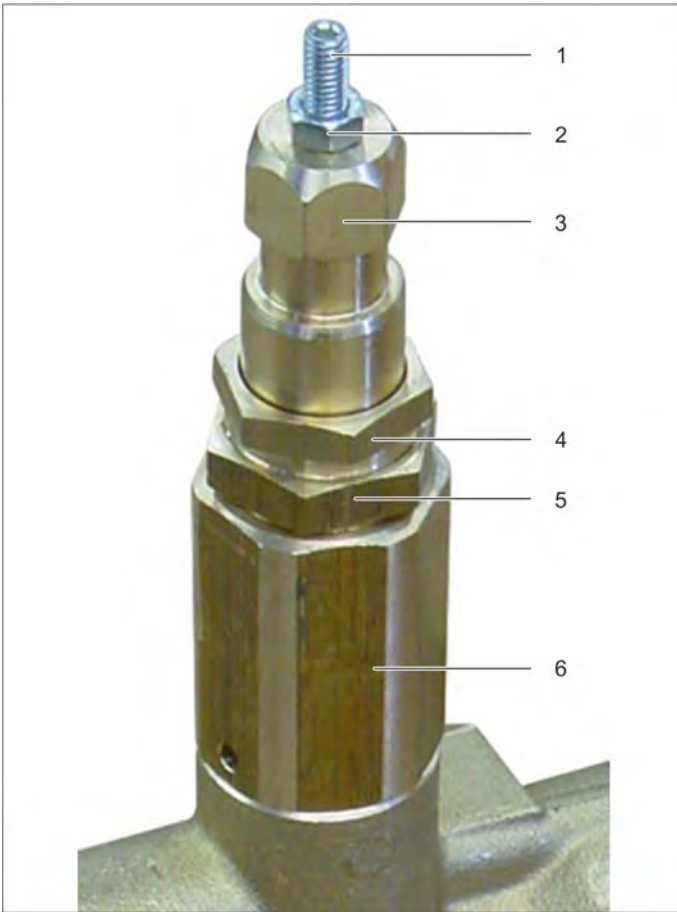

- 1 Adjustment screw, high pressure
- 2 Lock nut, adjustment screw, high pressure
- 3 Spindle, pressure and quantity regulation
- 4 Adjustment screw, low pressure
- 5 Lock nut, adjustment screw, low pressure
- 6 Housing, overflow valve

- ➔ Fasten the test manometer to the high-pressure connection.
- ➔ Connect the high-pressure hose and gun to the test manometer.
- ➔ Install the **new** high pressure nozzle.
- ➔ Completely open the control knob on the gun (turn towards "+").
- ➔ Actuate the trigger on the gun and switch on the appliance.
- ➔ Rotate the rotating handle of the pressure regulator on the pump anti-clockwise (direction "-") all the way to the stop.
- ➔ Pull off the rotary handle on the pressure regulator.
- ➔ Loosen the locknut of the adjustment screw for low pressure.
- ➔ Turn the adjustment screw low pressure together with the spindle until the minimum working pressure of the overflow valve is reached on the test manometer (see technical data, partial load).

Note

If this screw is turned clockwise, the pressure is increased; and if it is turned counter-clockwise, the pressure is decreased.

- ➔ Secure the adjustment screw for low pressure by tightening the locknut.
- ➔ Check the working pressure, feed volume and switch points of the pressure switches.
- ➔ Then seal this setting.

Note

With minimum pressure and volume adjustments and when using the supplied steam nozzle, the pressure must not exceed 32 bar.

7.50 Setting the working pressure with standard gun without rotary knob

7.50.1 Setting the maximum working pressure



- 1 Adjustment screw, high pressure
- 2 Lock nut, adjustment screw, high pressure
- 3 Spindle, pressure and quantity regulation
- 4 Adjustment screw, low pressure
- 5 Lock nut, adjustment screw, low pressure
- 6 Housing, overflow valve

- Fasten the test manometer to the high-pressure connection.
- Connect high-pressure hose with standard gun to the test pressure gauge.
- Install the **new** high pressure nozzle.
- Open standard gun.
- Turning on the appliance.
- Screw in the twist grip of the pressure and volume regulation on the pump all the way to the stop (towards "+").
- Pull off the rotary handle.
- Loosen the locknut of the adjustment screw for high pressure.
- Turn the adjustment screw high pressure in a way that the opening pressure of the overflow valve is reached on the test manometer.

Note

If this screw is turned clockwise, the pressure is increased; and if it is turned counter-clockwise, the pressure is decreased.

- Secure the adjustment screw for high pressure by tightening the locknut.
- Check the working pressure, feed volume and switch points of the pressure switches.
- Then seal this setting.

Note

The maximum working pressure is set with the standard gun without control knob.

7.50.2 Setting the minimum working pressure

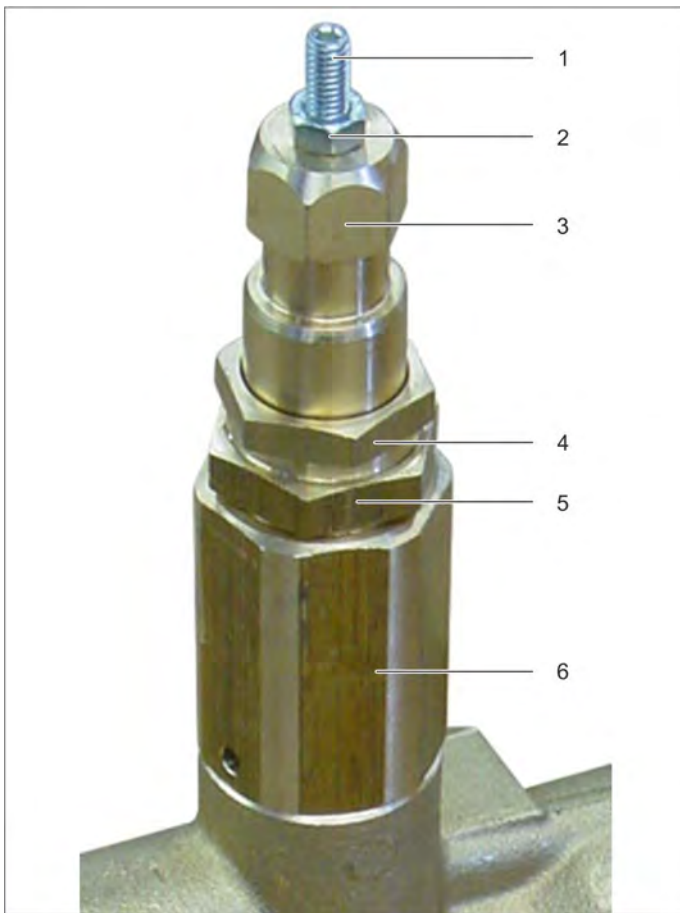

- 1 Adjustment screw, high pressure
- 2 Lock nut, adjustment screw, high pressure
- 3 Spindle, pressure and quantity regulation
- 4 Adjustment screw, low pressure
- 5 Lock nut, adjustment screw, low pressure
- 6 Housing, overflow valve

- ➔ Fasten the test manometer to the high-pressure connection.
- ➔ Connect high-pressure hose with standard gun to the test pressure gauge.
- ➔ Install the **new** high pressure nozzle.
- ➔ Open standard gun.
- ➔ Turning on the appliance.
- ➔ Rotate the rotating handle of the pressure regulator on the pump anti-clockwise (direction "-") all the way to the stop.
- ➔ Pull off the rotary handle.
- ➔ Loosen the locknut of the adjustment screw for low pressure.
- ➔ Turn the adjustment screw low pressure and the spindle until the minimum working pressure is reached.

Note

If this screw is turned clockwise, the pressure is increased; and if it is turned counter-clockwise, the pressure is decreased.

- ➔ Secure the adjustment screw for low pressure by tightening the locknut.
- ➔ Check the working pressure, feed volume and switch points of the pressure switches.
- ➔ Then seal this setting.

Note

With minimum pressure and volume adjustments and when using the supplied steam nozzle, the pressure must not exceed 32 bar.







8 Care and maintenance

Service group does not contain any maintenance and inspection points.

9 Troubleshooting

Failure	Measure
Device is not running (no LED/display indication)	<ul style="list-style-type: none"> – Check/replace mains voltage, connecting cable and mains fuse. – Check the fuse (F1). – Check/replace the power switch. – Check/replace the pressure switch – Check/adjust/replace control transformer. – Check/replace the temperature fuse. – Check/replace the PCB. – Unplug the RFID cable from the PCB and switch RFID in the software.
Device is not running, LED standby is on or the display shows three filling levels	<ul style="list-style-type: none"> – Check pressure switch electrically and mechanically.
Winding protection contact was triggered	<ul style="list-style-type: none"> – Switch off appliance and let it cool down. Remove the cause of the problem. Turn on the appliance again.
Water pressure too low	<ul style="list-style-type: none"> – Check/raise the water input amount. – Check/clean/replace water fine filter. – Vent appliance. – Check/replace high-pressure nozzle. – Check/replace the pressure and suction valves – Check / adjust/ replace overflow valve. – Check/adjust/replace safety valve.
Water is not being heated	<ul style="list-style-type: none"> – Check/correct temperature setting. – If the water shortage safeguard is switched off, ensure sufficient water supply/repair water shortage safeguard. – Check/refill fuel level in the tank. – Check/replace the solenoid valve fuel pump. – Check/replace fuel filter. – Check/correct the setting of the fuel pump. – Check/correct fuel nozzle. – Check/replace ignition cables. – Check/correct distances of the ignition electrodes. – Check/repair burner blower. – Check/correct setting of the air flap.
Control LED is on	<ul style="list-style-type: none"> – <i>5.4.1 Control panel with LED indicator</i>
During operation, all 10 LEDs are blinking at the same time, device switches off	<ul style="list-style-type: none"> – Check service switch and ribbon cable.
Inadequate or no detergent function	<ul style="list-style-type: none"> – Check/correct dosing valve setting. – Check/clean detergent tank. – Check/clean/replace detergent filter. – Check/replace detergent hose, dosing valve and detergent inlet at the cylinder head.
Pressure reduction in the HP system	<ul style="list-style-type: none"> – Check the trigger gun and the O-rings on the high-pressure hose for leaks / replace. – Check the pressure holding valve for leaks/replace the O-rings. – Check / adjust/ replace overflow valve. – Check/replace the pressure switch and control piston.
Water leak between the cylinder head and the piston casing	<ul style="list-style-type: none"> – Leakiness of 1 drop per minute and piston is acceptable. – Check/replace high pressure and low pressure seals.
Oil leaks between the cylinder head and the piston casing	<ul style="list-style-type: none"> – Replace the oil seals.
Pump is vibrating	<ul style="list-style-type: none"> – Check pump for leaks/eliminate leaks. – Vent appliance.







9.1 Error messages

Display	Explanation	Remark
	Rotating field of the motor incorrect.	Perform a phase inversion in the commutating pole plug.
	Thermal motor protection switch (WSK) in the motor has tripped.	Switch off the device and allow the motor to cool down.
	Mains voltage too low or too high or phase failed or the motor current is too high.	Check power supply. Check the pump for sluggishness.
	Water shortage (dry running after 2 minutes).	Open tap. Ensure water supply.
	Exhaust temperature is too high	Perform maintenance on the burner.
	Time monitoring active for 30 minutes, continuous break/continuous operation	Switch the device off and back on.

9.2 Error message with service demand

Note

One display for multiple faults is used here. By reading the fault memory, the fault can possibly be localized. (Service mode 70°C)

Display	Explanation	Remark
	Water shortage safeguard (reed switch or magnetic piston is sticky).	Check water shortage safeguard.
	10 short startups/leakage.	Rectify leaks in the HP system.
	Contactor does not switch.	Check contactor. Check installation of the current transformer. This fault is not saved.
	Water temperature sensor (NTC) defective.	Check NTC. Cable NTC scraped blank or interrupted.
	Flame sensor detects condition that is not permitted.	Possible causes: – Fuel solenoid valve – Fuel line/filter – Stray light – Sight glass sooted – Combustion chamber scaled – Fuel empty and fuel empty message defective
	RFID write-read electronics defective.	Check connection to the RFID write-read electronics.

10 Technical specifications

Appliance type	Appliance no.	Circuit diagram	Operating instructions	Spare parts list
HDS 7/12-4 M	1.077-410.0	0.089-021	5.964-883.0	5.972-064.0
HDS 7/12-4 MX	1.077-450.0	0.089-021	5.964-883.0	5.972-064.0
HDS 8/18-4 M	1.077-609.0	0.089-025	5.964-883.0	5.972-275.0
HDS 8/18-4 MX	1.077-650.0	0.089-025	5.964-883.0	5.972-275.0
HDS 9/18-4 M	1.077-810.0	0.089-025	5.964-883.0	5.965-902.0
HDS 9/18-4 MX	1.077-850.0	0.089-025	5.964-883.0	5.965-902.0
HDS 10/20-4 M	1.071-420.0	0.088-952	5.964-883.0	5.971-982.0
HDS 10/20-4 MX	1.071-456.0	0.088-952	5.964-883.0	5.971-982.0
HDS 12/18-4 S	1.071-620.0	0.088-952	5.964-883.0	5.972-173.0
HDS 12/18-4 SX	1.071-650.0	0.088-952	5.964-883.0	5.972-173.0
HDS 13/20-4 S	1.071-800.0	0.089-026	5.965-833.0	5.972-204.0
HDS 13/20-4 SX	1.071-850.0	0.089-026	5.965-833.0	5.972-204.0

10.1 Tightening torques

Cylinder head screws	50 - 60 Nm
Piston casing	5 - 7 Nm
Gun, pressure regulator	40 Nm
High pressure outlet	6 - 8 Nm
Pressure valve screw connection	40 - 45 Nm
Pressure valve screw connection	30 - 35 Nm
Suction valve screw connection	15 - 17 Nm
Overflow valve seat	8 - 10 Nm
Swash plate	12 +/- 3 Nm
Oil drain screw	20 - 25 Nm
Motor cover, rear	9 - 10 Nm
Blower wheel	7 - 8 Nm

11 Special tools

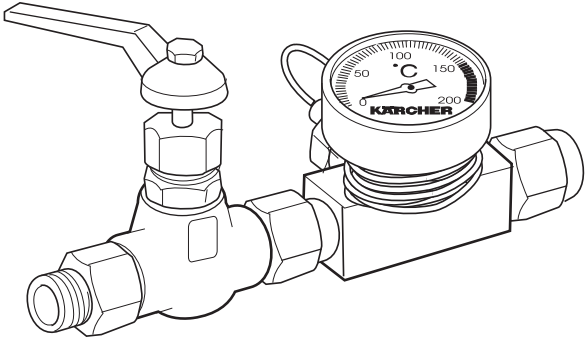
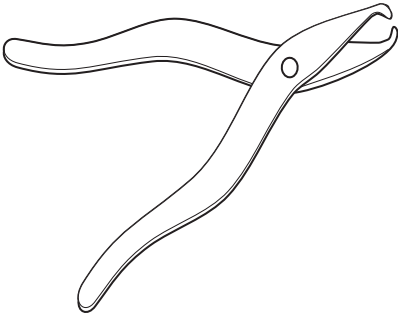
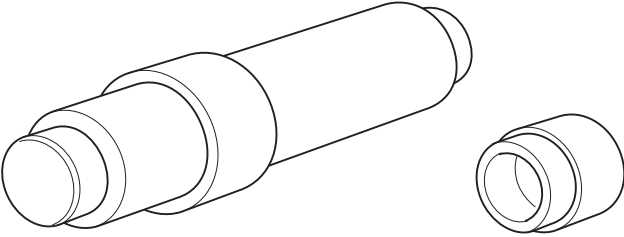
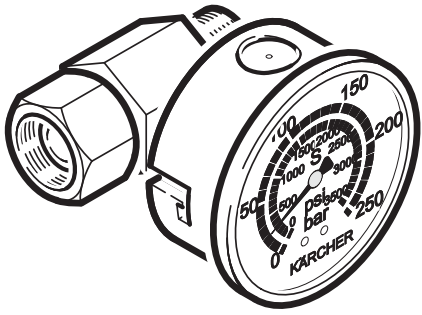
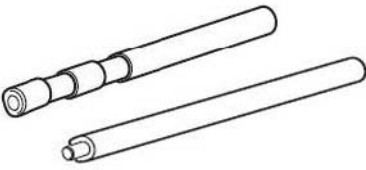
			
Electric measuring appliance	6.803-022.0	Shut-off valve with thermometer	2.901-030.0
			
Removal pliers, pressure/suction valves and water sieves	4.901-062.0	Installation mandrel oil seal, high-pressure seal Piston diameter 18mm	5.901-062.0
		Installation sleeve, high pressure seal Piston diameter 18mm	5.901-118.0
		Installation mandrel oil seal, high-pressure seal Piston diameter 20mm	5.901-055.0
		Installation sleeve, high pressure seal Piston diameter 20mm	5.901-194.0
		Installation mandrel oil seal Piston diameter 22mm	5.901-064.0
		Installation mandrel high pressure gasket Piston diameter 22mm	5.901-018.0
		Installation sleeve, high pressure seal Piston diameter 22mm	5.901-136.0
			
Test manometer for working pressure	4.742-025.0	Disassembly overflow valve seat Assembly overflow valve seat	5.901-161.0 5.901-162.0

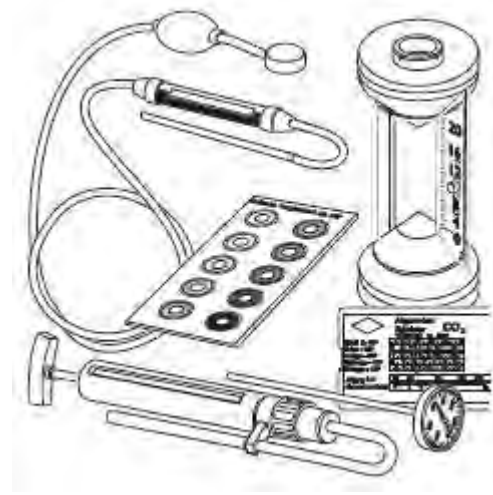
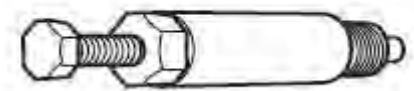
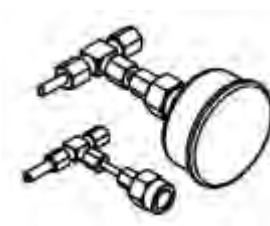
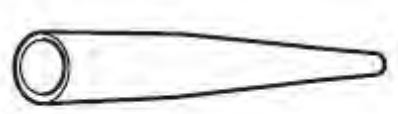
			
<p>Soot pump Soot filter paper Soot pattern scale Thermometer Hardness indicator A Indicator paper</p> <p>Obtain recommended measuring devices, Testo 320 or Testo 320-2-LL - measuring device CO2, directly from the supplier.</p> <p>Note Additionally required for both measuring devices:</p> <ul style="list-style-type: none"> - Power Supply - Device case - Flue gas probe 	<p>6.775-001.0 6.775-002.0 6.775-003.0 6.432-029.0 6.768-004.0 6.768-006.0</p>	<p>Puller for swashing plate</p>	<p>4.901-038.0</p>
			
<p>Pressure gauge for fuel pressure</p>	<p>4.901-060.0</p>	<p>Installation mandrel for O-ring/support ring, overflow piston</p>	<p>5.901-163.0</p>



Mounting screws for piston guide (M8 x 75)

7.304-403.0

Mounting screws for piston guide (M6 x 110)

7.304-467.0

12 Circuit diagram

Note

Please observe the most current circuit diagrams in DISIS.

Circuit diagram 0.089-021.0 HDS 7/12

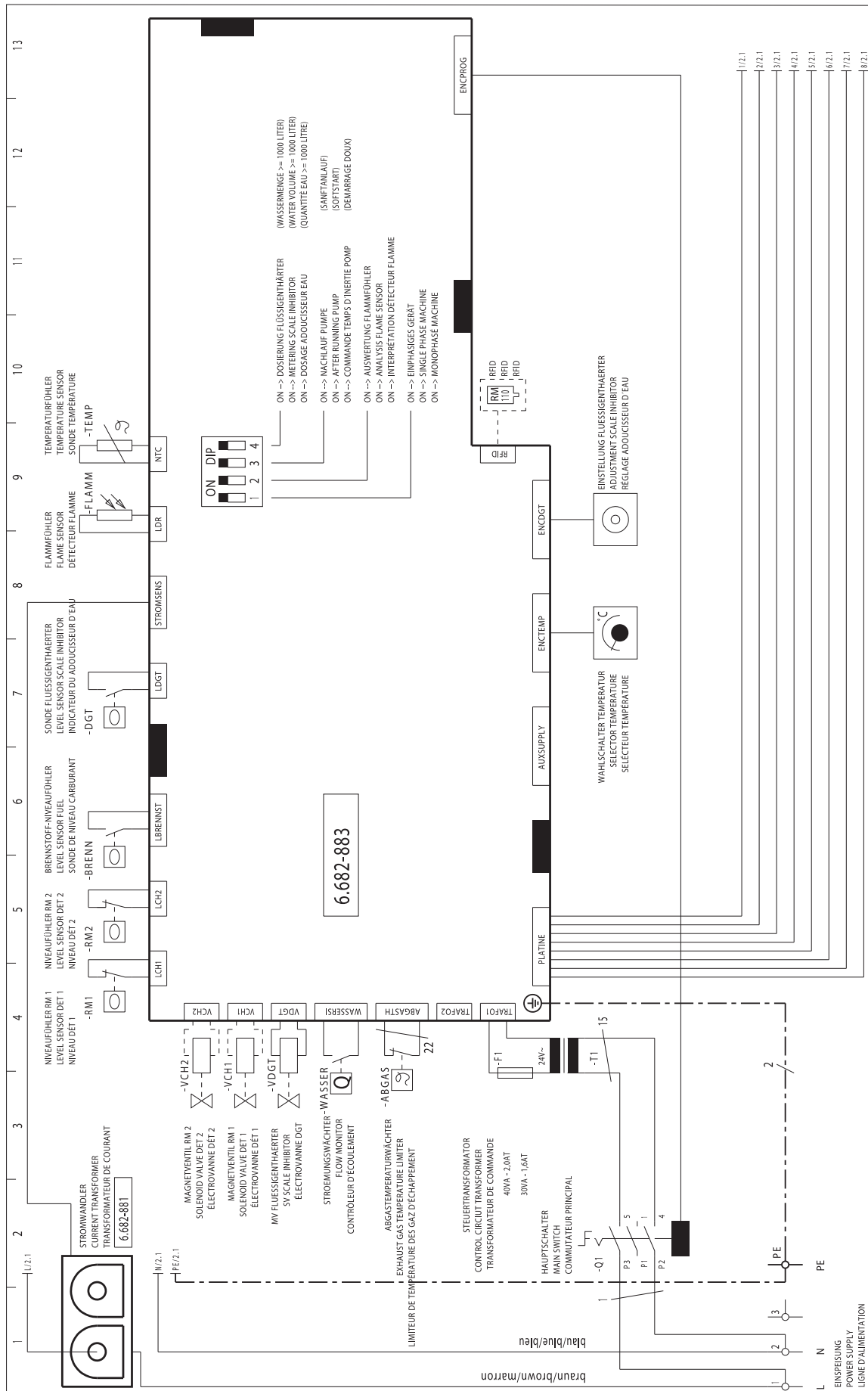

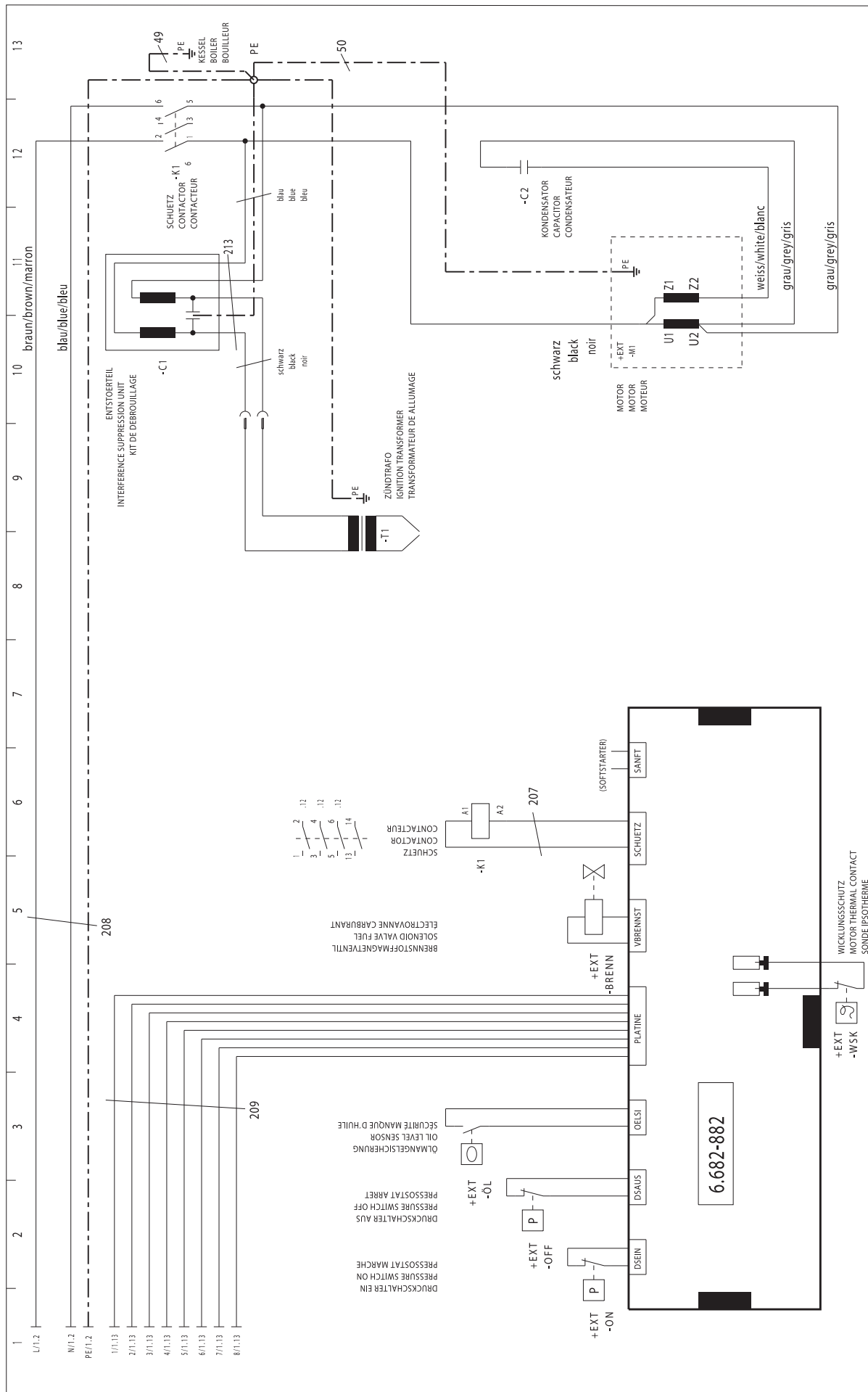

Circuit diagram 0.089-025.0 HDS 8/18, HDS 9/18

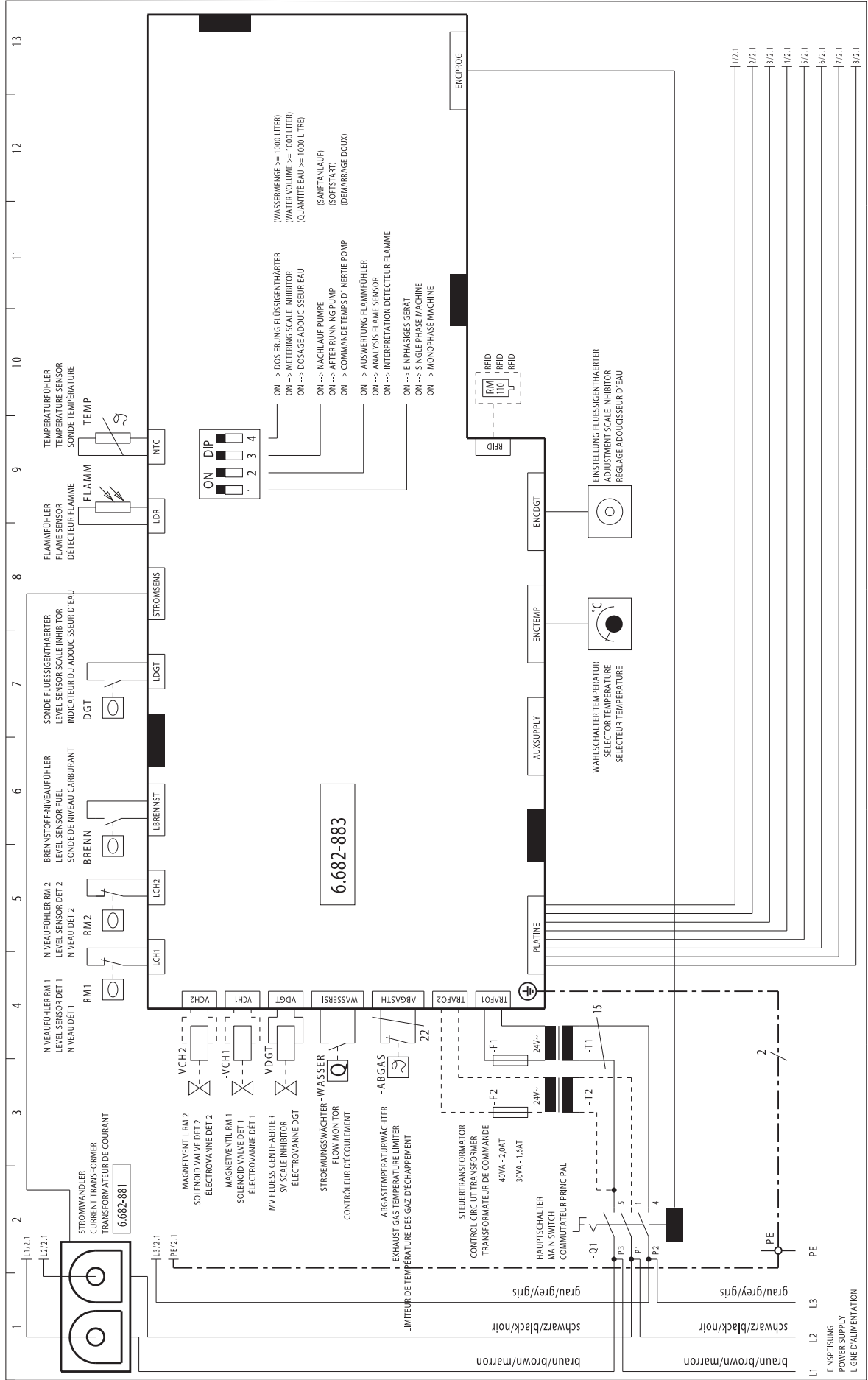

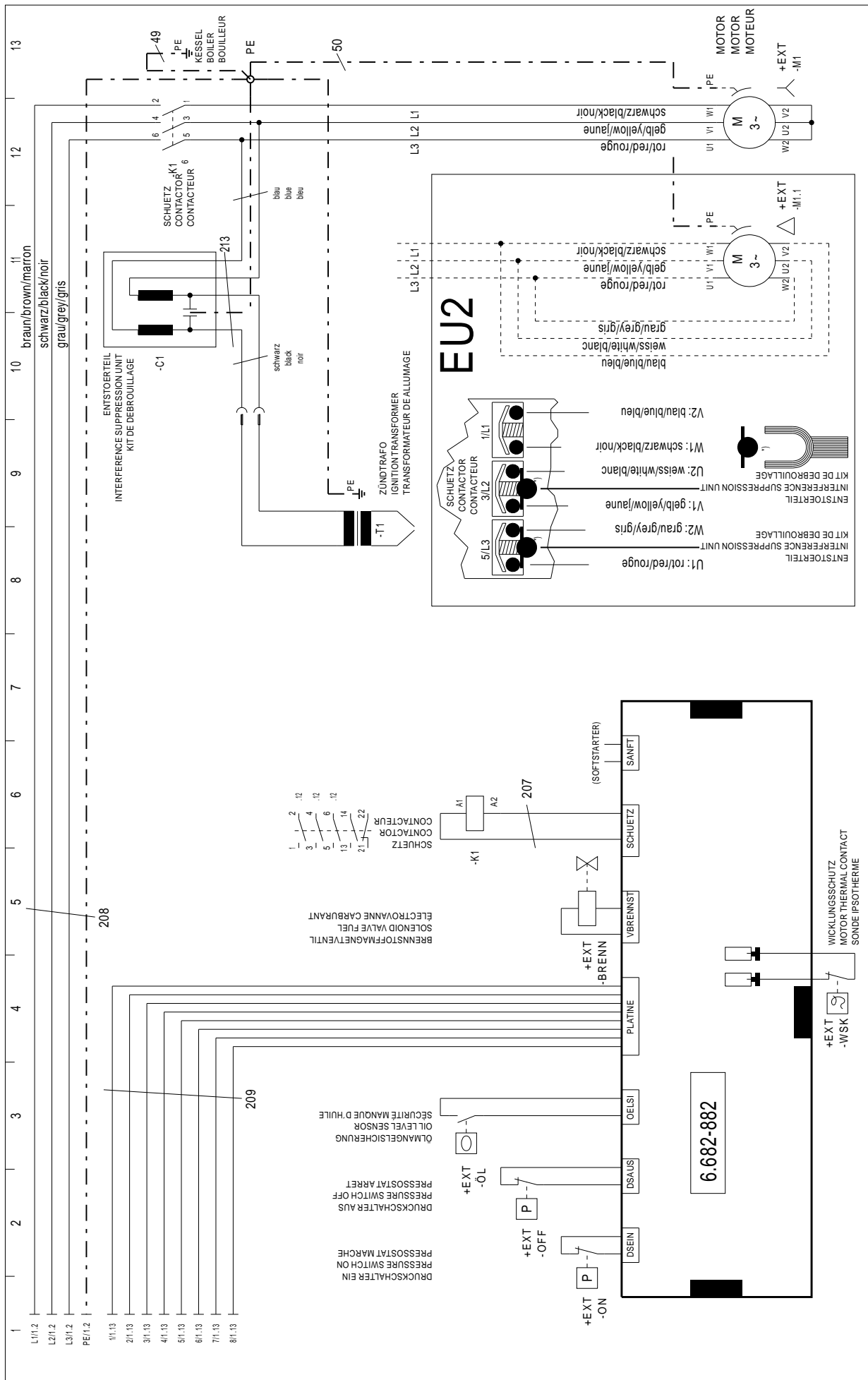

Circuit diagram 0.088-952.0 HDS 10/20, HDS 12/18

