

SG 4/4

Service Manual



Preface	4
Safety instructions	4
Hazard levels	4
Description in this service manual	5
Service groups	5
Functional group structure	5
Textual description	5
Technical Features	5
Type plate	5
AB Service group setup	6
010 Safety information	6
General	6
020 Overview	6
030 Function	6
040 Service activities	7
ABRD Uninstall / install wheels	7
ABGE Uninstalling / installing cover	7
ABNT Uninstalling and installing the refill tank	8
050 Maintenance and inspection	9
060 Error diagnosis	9
070 Peculiarities/ others	9
AD Service group steam system	10
010 Safety information	10
General	10
020 Overview	10
Operating field	11
Position reset key descaling	11
030 Function	12
Functional diagram	12
Filling in and heating up water	12
Working with the steam gun	13
Descaling the pressure tank	13
Safety installations	13
Water shortage thermostat	13
Safety thermostat	13
Pressure controller	14
Safety lock	14
040 Service activities	14
ADDR Uninstalling / installing the pressure regulator	14
ADMA Uninstall / install solenoid valve	14
ARDR Uninstalling / installing the control valve steam volume	15
ADRW Uninstalling / installing the control valve water volume	15
ADTH Uninstalling / installing thermostat	15
ADTW Uninstall / install water shortage thermostat	16
ADWF Uninstalling / installing water filter	16
ADWP Uninstall / install water pump	17
050 Maintenance and inspection	17
060 Error diagnosis	17
070 Peculiarities/ others	17
AH Service group electrics	18
010 Safety information	18
020 Overview	18
030 Function	18
040 Service activities	19
AHNK Uninstalling / installing mains connection	19
AHSD Uninstalling / installing switch for steam supply	19

AHSH Uninstalling / installing switch for heating	19
AHKL Uninstalling / installing indicator lights	20
AHTR Uninstalling / installing transformer	20
AHAE Uninstalling / installing switch-off electronics	20
050 Maintenance and inspection	21
060 Error diagnosis	21
070 Peculiarities/ others	21
Technical specifications	22
Circuit diagram	22
Troubleshooting	23
Measured values	24
010 Safety information	24
Voltage measurement	25

Preface

Good service work requires extensive and practice-oriented training as well as well-structured training materials. Hence we offer regular basic and advanced training programmes covering the entire product range for all service engineers.

In addition to this, we also prepare service manuals for important appliances - these can be initially used as instruction guides and later on as reference guides.

Apart from this, we also regular information about product enhancements and their servicing.

If you should require supplements, have corrections or questions regarding this document, please address these citing the following subject to:

international-service@de.kaercher.com

Subject:	Fall 118906
----------	--------------------

The responsible product specialist will take care of your issue.

Copying and duplication of texts and diagrams as well as third-party access to this information is permitted only with the explicit permission of the company:

Alfred Kärcher GmbH & Co. KG

P O Box 160

D -71349 Winnenden

www.kaercher.com

Safety instructions

Service and maintenance tasks may only be performed by qualified and specially trained specialists.

Observe safety information in the chapters!

⚠ DANGER

Prior to all work on the appliance, switch off the appliance and pull the power plug.

⚠ CAUTION

Risk of damage by electrostatic discharge (ESD)! Take suitable measures for discharging electrostatic charge prior to performing work on the appliance electronics.

Hazard levels

⚠ DANGER

For an immediate danger which can lead to severe injuries or death.

⚠ WARNING

For a possibly dangerous situation which could lead to severe injuries or death.

⚠ CAUTION

For a possibly dangerous situation which can lead to minor injuries or property damage.

ATTENTION

Pointer to a possibly dangerous situation, which can lead to property damage.

Note

Indicates useful tips and important information.

Description in this service manual

Service groups

Example:

Install/uninstall ANRA wheel axle

AN	RA	Install/uninstall wheel axle
Service group	Component	Activity

Observe the allocation of service groups to the appliance components in the overview diagram in Chapter "Overview over the service and functional groups".

Functional group structure

010	Safety instructions
020	Overview
030	Function
040	Service activities
050	Maintenance and inspection
060	Error diagnosis
070	Peculiarities/ others
080 - 100	Not assigned

Textual description

→ Instruction

■ Preparatory operations

1

2 Key numerical

A

B Key alphanumerical

– Enumeration / General list

⚠ **Safety note**

Pointer to hazards, sources of errors.

Technical Features

Type plate

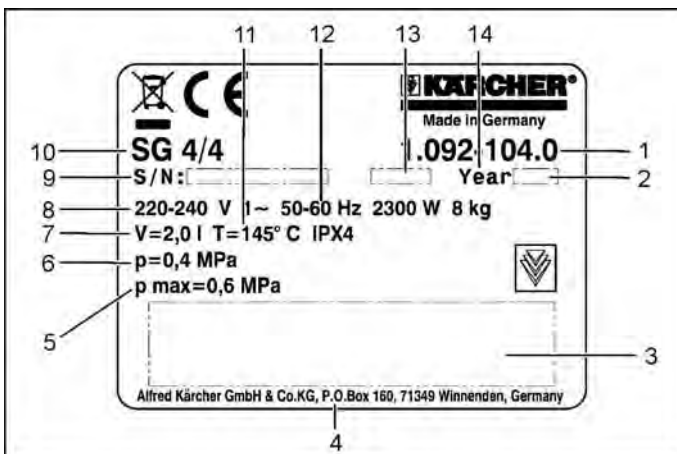

The type plate is located at the bottom of the appliance.

- 1 Part number
- 2 Year of manufacture
- 3 Bar code. Contains part and serial number.
- 4 Address of manufacturer
- 5 Max. operating pressure
- 6 Permitted operating pressure
- 7 Tank content
- 8 Main Supply
- 9 Serial number
- 10 Appliance description
- 11 Max. work temperature
- 12 Type of protection
- 13 Connection output
- 14 Typical operating weight

AB Service group setup

010 Safety information

General

Observe general safety information!

Service and maintenance tasks may only be performed by qualified and specially trained specialists.

⚠ DANGER

- *Switch off the appliance and, in case of appliances connected to the mains, pull out the power cord before cleaning and performing any maintenance tasks on the machine.*
- *Maintenance work may only be carried out by approved customer service outlets or experts in this field who are familiar with the respective safety regulations.*
- *To avoid risks, all repairs and replacement of spare parts may only be carried out by the authorised customer service personnel.*
- *Only use accessories and spare parts which have been approved by the manufacturer. The exclusive use of original accessories and original spare parts ensures that the appliance can be operated safely and trouble free.*
- *Allow the appliance to cool down prior to performing service tasks.*

020 Overview



ABRD Uninstall / install wheels

ABGE Uninstalling / installing cover

ABNT Uninstalling and installing the refill tank

030 Function

No special functional characteristics.

040 Service activities

Note

Unless otherwise described, the installation takes place in reverse order.

ABRD Uninstall / install wheels

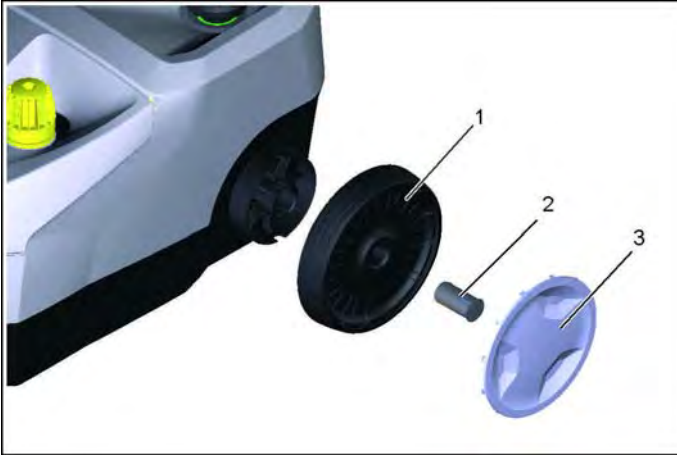

- 1 Wheel
- 2 Bolts
- 3 Wheel cap

- ➔ Remove the wheel cover.
- ➔ Remove the bolt.
- ➔ Remove wheel.

ABGE Uninstalling / installing cover



- ABRD Uninstall / install wheels

- 1 Screws
- ➔ Unscrew the screws



- 1 Safety lock
- 2 Rotary knob

- ➔ Remove the safety lock from the device.
- ➔ Turn rotary knobs to minimum

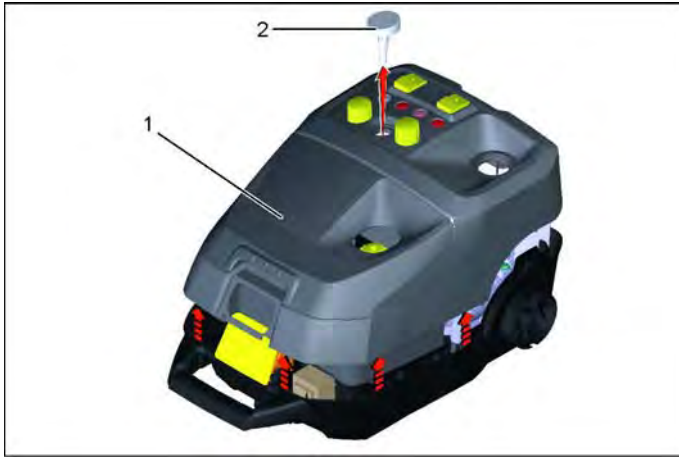

- 1 Cover
- 2 Thermostat

- ➔ Gently raise the front cover.
- ➔ Remove the thermostat.
- ➔ Put appliance cover aside.

Installation information

Grease the thermostat with heat-conducting paste.
 Lay lines free of kinks.
 Uninstall the rotary knobs for easier installation of the cover.
 Perform a function test.

ABNT Uninstalling and installing the refill tank

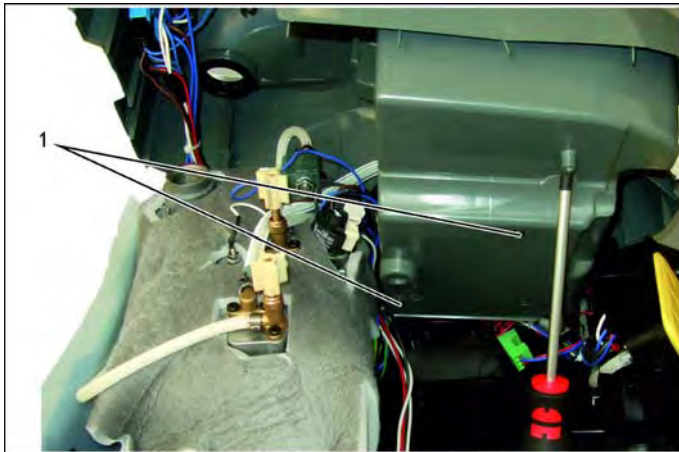

- ABRD Uninstall / install wheels
- ABGE Uninstalling / installing cover

- 1 Screws
- ➔ Unscrew the screws.

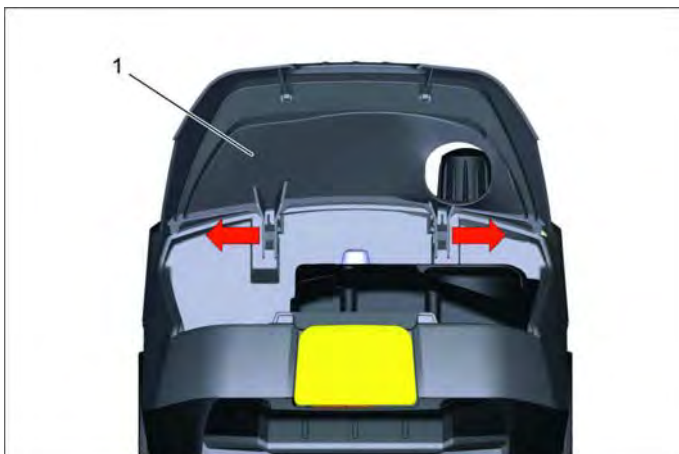

- 1 Hood
- ➔ Remove the hood.

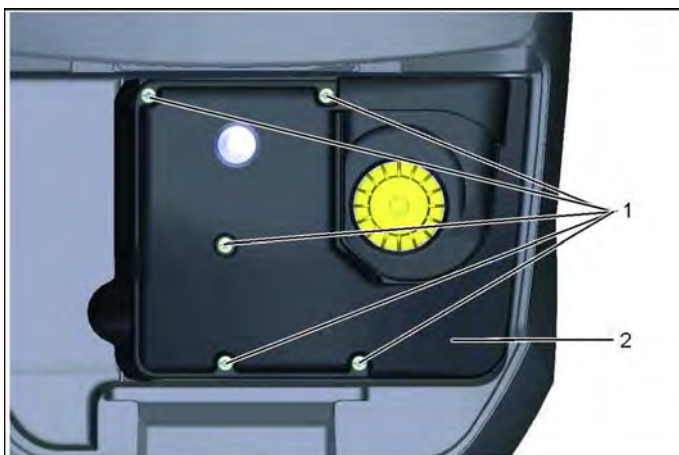

- 1 Screws
- ➔ Unscrew the screws

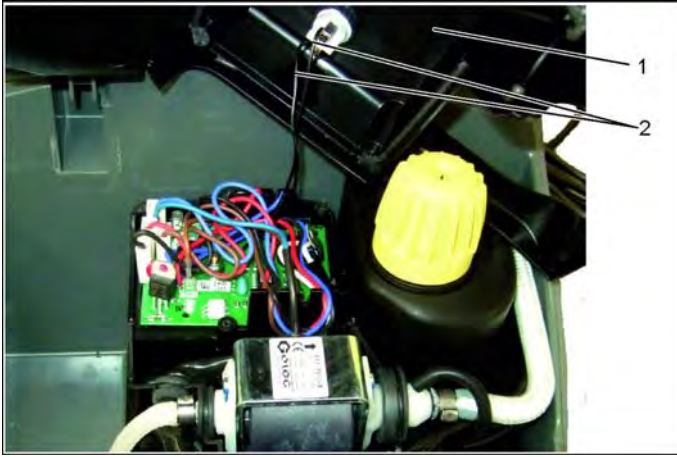

- 1 Cover
- 2 Pipes

- ➔ Lift the cover.
- ➔ Disconnect lines.
- ➔ Remove cover.

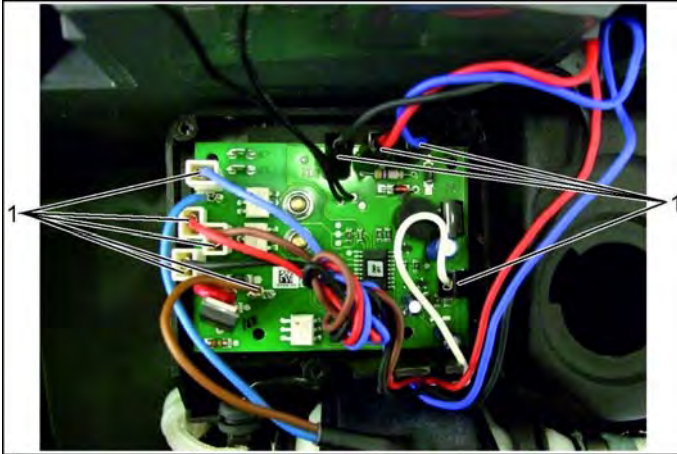

- 1 Connector

- ➔ Disconnect the connectors.



- 1 Hose clamps
- 2 Hose
- 3 Water pump
- 4 Tank

- ➔ Loosen the hose clamps.
- ➔ Pull out the hoses.
- ➔ Remove the water pump.
- ➔ Remove the tank.

050 Maintenance and inspection

Service group does not contain any maintenance and inspection points.

060 Error diagnosis

The service group does not contain any error diagnosis.

070 Peculiarities/ others

The service group does not contain any peculiarities.

AD Service group steam system

010 Safety information

General

Observe general safety information!

Service and maintenance tasks may only be performed by qualified and specially trained specialists.

⚠ DANGER

- Switch off the appliance and, in case of appliances connected to the mains, pull out the power cord before cleaning and performing any maintenance tasks on the machine.
 - Maintenance work may only be carried out by approved customer service outlets or experts in this field who are familiar with the respective safety regulations.
 - To avoid risks, all repairs and replacement of spare parts may only be carried out by the authorised customer service personnel.
 - Only use accessories and spare parts which have been approved by the manufacturer. The exclusive use of original accessories and original spare parts ensures that the appliance can be operated safely and trouble free.
- Allow the appliance to cool down prior to performing service tasks.

020 Overview

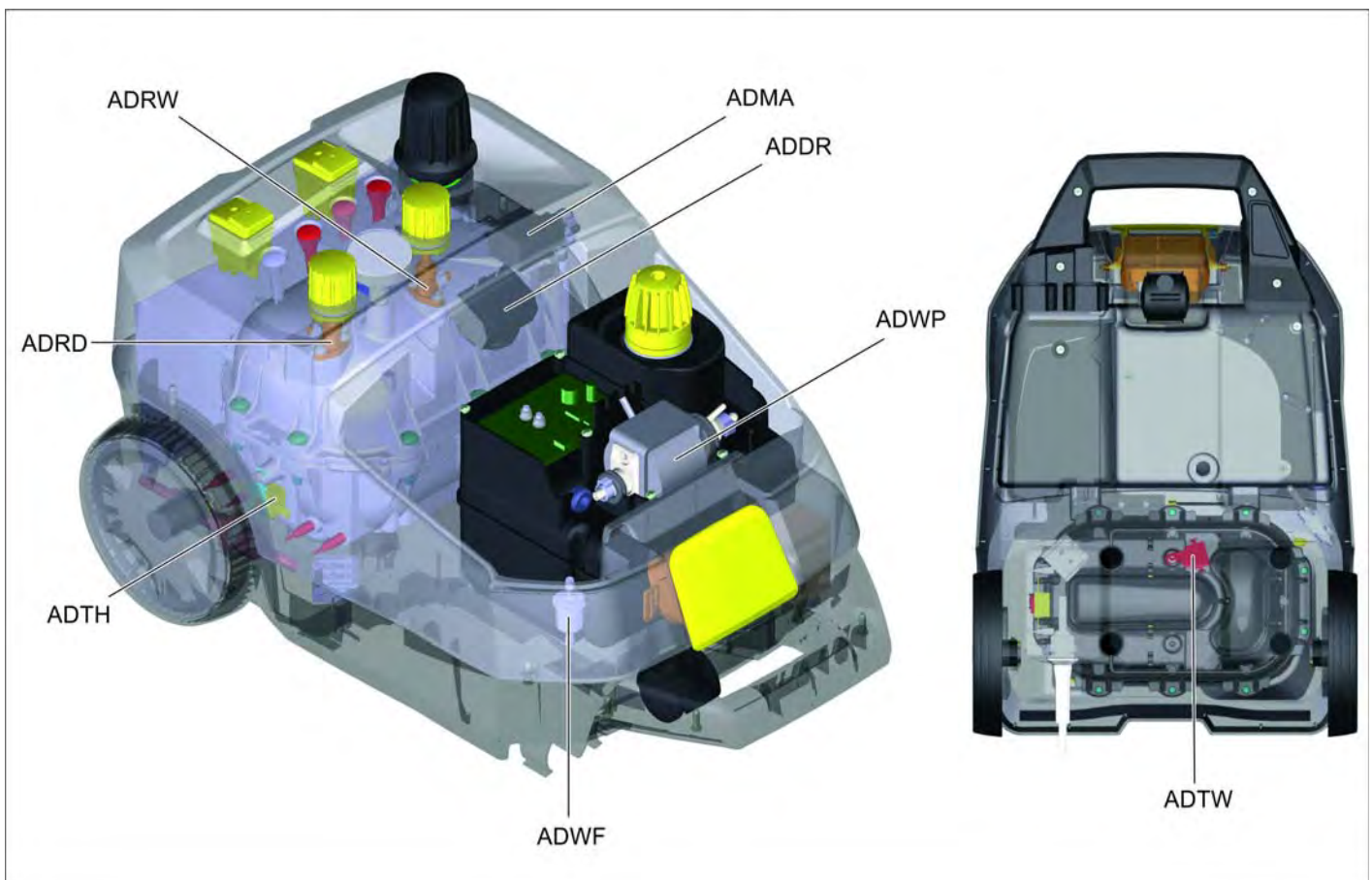

ADDR Uninstalling / installing the pressure regulator

ADMA Uninstall / install solenoid valve

ADDR Uninstalling / installing the control valve steam volume

ADRW Uninstalling / installing the control valve water volume

ADTH Uninstalling / installing thermostat

ADTW Uninstall / install water shortage thermostat

ADWF Uninstalling / installing water filter

ADWP Uninstall / install water pump

Operating field

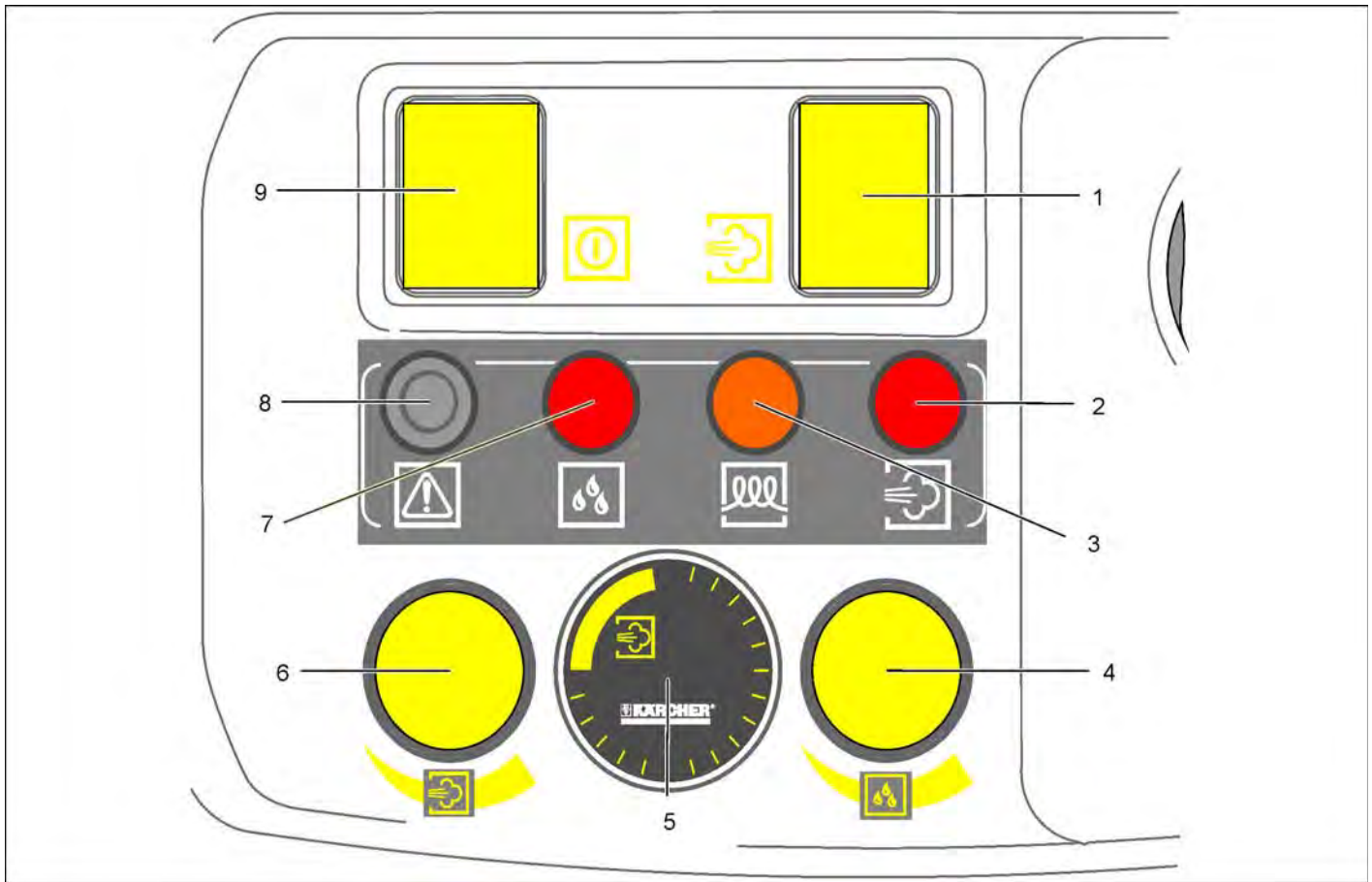

- | | |
|--|---|
| 1 Steam supply switch | 6 Rotary knob for steam quantity controller |
| 2 Indicator lamp - water shortage steam boiler (red) | 7 Indicator light - water shortage fresh water tank (red) |
| 3 Indicator lamp - heating (yellow) | 8 Indicator lamp - Descaling (white) |
| 4 Rotary knob for VAPOHYDRO regulation | 9 Switch heating "ON/OFF" |
| 5 Temperature display | |

Position reset key descaling



- | |
|-------------------------|
| 1 Reset key - Descaling |
|-------------------------|

030 Function

Functional diagram

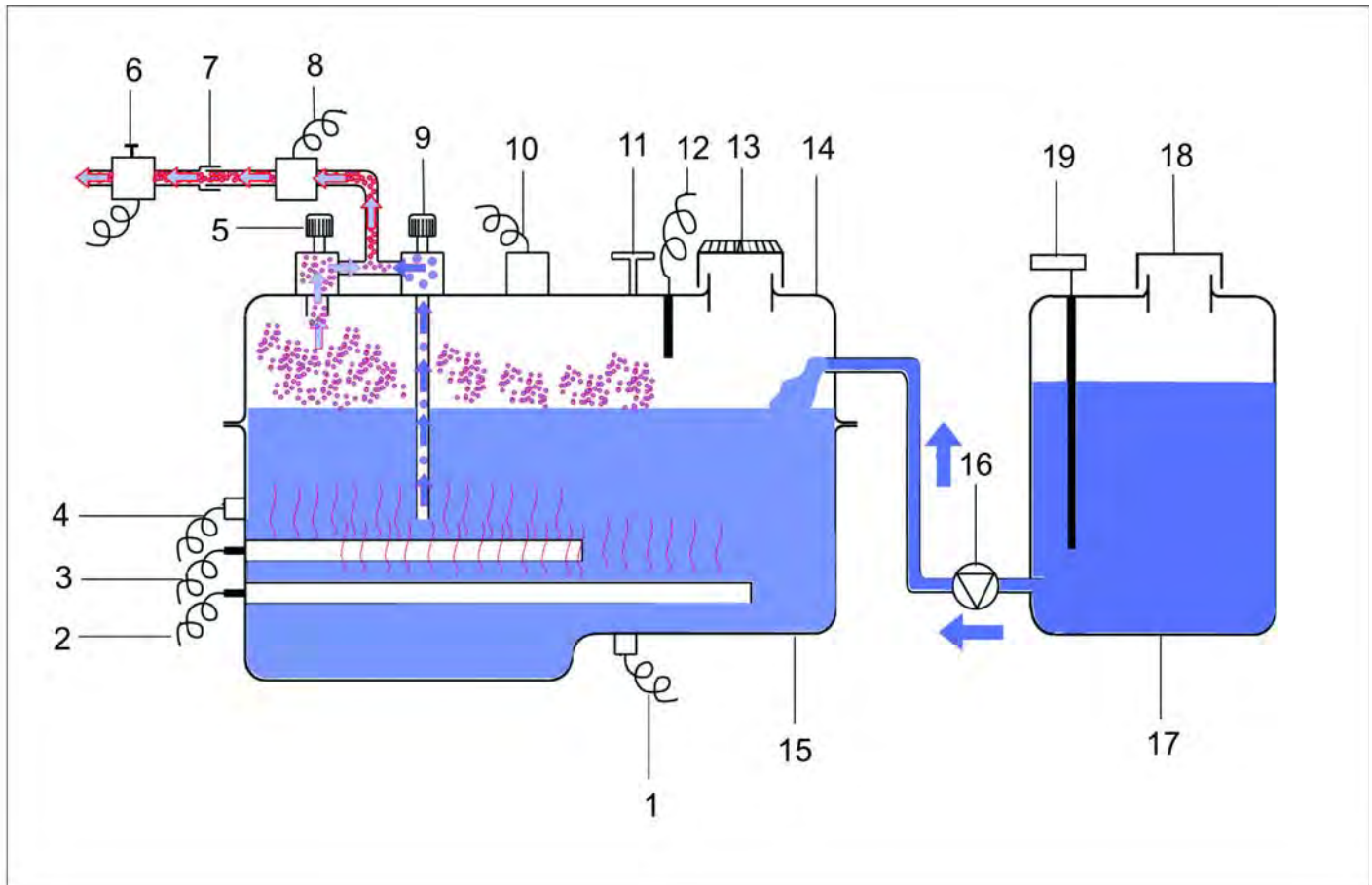

1 Low-water thermostat

2 Heating
1500 W

3 Heating
750 W

4 Thermostat

5 Control valve steam volume

6 Steam switch on the gun

7 Plug

8 Solenoid valve

9 VAPOHYDRO control valve with riser

10 Pressure regulator

11 Temperature display

12 Level sensor

13 Safety lock

14 Pressure container
Upper section

15 Pressure container
Lower part

16 Pump with check valve

17 Refill tank

18 Lock refill tank

19 Switch-off electronics

Filling in and heating up water

The safety lock can only be opened for filling in water if there is less than 0.2 bar inner pressure in the pressure tank. If the pressure is higher, it must be reduced via the steam gun first.

The refill tank is unheated and depressurised.

The water level is monitored by the level sensor.

If the plug is plugged into the device, both heaters heat the water in the pressure tank.

If the modular accessory plug is not plugged in, only the heating 1500 W is heating.

The pressure regulator switches the heating off as soon as the set steam pressure has been reached.

The level sensor monitors the water level in the pressure tank. If the water level falls under a certain level due to the

steam consumption, the water pump is switched on. This delivers water from the refill tank to the pressure tank until the water level there has increased so much that the level sensor switches the water pump off again.

When the water in the refill tank is used, an audible signal sounds 8 times and the indicator light "water shortage refill tank" lights up.

The water can immediately be refilled there without switching off the heating.

If water and steam are completely consumed, the thermostat water shortage switches off the heating. At the lowest point of the pressure tank, underneath the heating, a small amount of water remains. This is enough to reduce the pressure tank temperature quickly to below 100°C. This way, there is no risk that water splashes back upon refilling the pressure tank and scalds the user.

Working with the steam gun

If the steam switch is pushed on the gun, the solenoid valve opens and the steam flows from the pressure tank through the plug forward to the steam gun.

With the control valve steam volume the steam volume can be adjusted.

In addition, hot water can be mixed into the steam by means of the VAPOHYDRO control valve.

If the valve is opened, water rises in the riser and mixes with the steam at the solenoid valve.

This way, the moisture of the steam can be regulated from dry steam (valve closed) to hot water jet (valve completely opened).

Descaling the pressure tank

After approx. 50 operating hours, the indicator light Descaling lights up (white).

This is an indication that the pressure tank must be descaled now at the latest.

To do so, completely dissolve the pouch contents of RM 511 in 1 litre of warm water.

Fill this solution into the pressure tank and allow to react for approximately 8 hours.

During this time, the pressure tank must remain open and must not be used.

After pouring out the solution, rinse the pressure tank with cold water at least twice in order to remove all residue.

Press the reset key until the indicator lamp "Descaling" goes off.

The appliance is ready for use again. After approx. 50 operating hours, the indicator lamp "Descaling" shows the next necessary descaling process.

Safety installations

Water shortage thermostat

The thermostat water shortage interrupts the circuit for the heating if the water in the pressure tank is consumed and the temperature rises further.

Red low-water indicator lamp lights up

When the temperature falls again, the water shortage thermostat automatically closes the circuit again and the indicator light goes out.

Safety thermostat

The thermostat is an additional safety element.

It interrupts the circuit for the heating if the thermostat water shortage is defective and the temperature has risen further.

If the thermostat has tripped, it will not switch back automatically.

The device must be opened in order to find out why the water shortage thermostat has not worked.

After detection and elimination of the error, the pin on the thermostat must be pushed in again.

Pressure controller

The pressure regulator interrupts the circuit for the heating if the specified steam pressure is reached in the pressure tank.

If the pressure in the pressure tank falls again, i.e. the steam has been consumed, the pressure switch automatically closes the circuit.

The pressure switch has 3 connections:

COM = Masse (earth,ground))

NO = normally opened

NC = normally closed

The pressure regulator is connected to the terminals COM and NC.

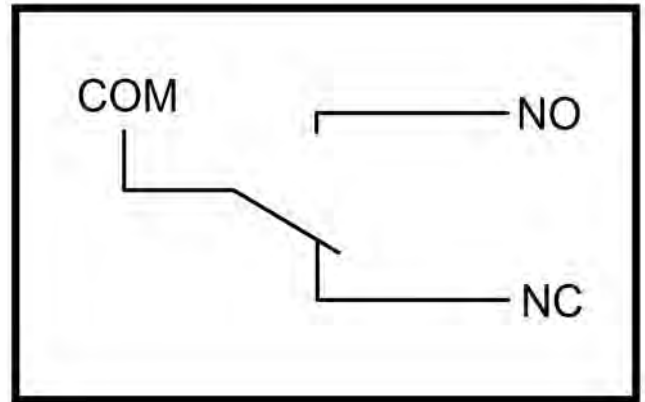

Safety lock

The safety lock is an additional safety element in the pressure tank lock.

It opens, if the pressure regulator is defective.

If the safety lock has opened, the pressure regulator must be checked in order to detect why it has not functioned.

040 Service activities

ADDR Uninstalling / installing the pressure regulator

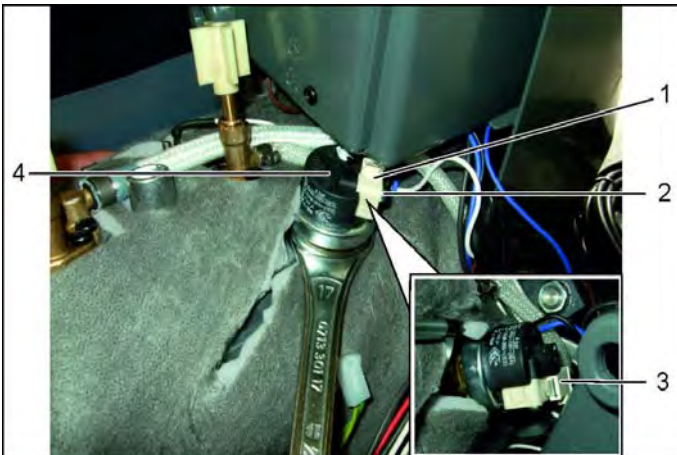

- ABRD Uninstall / install wheels
- ABGE Uninstalling / installing cover

- 1 Switch
- 2 Screws
- 3 Connector
- 4 Pressure regulator

- ➔ Disconnect the connector.
- ➔ Loosen screws.
- ➔ Remove the switch.
- ➔ Unscrew the pressure regulator.

Installation information

Check for leaks.

ADMA Uninstall / install solenoid valve

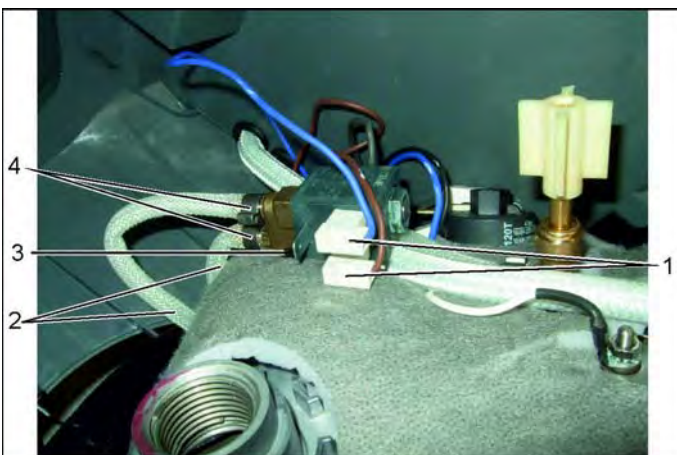

- ABRD Uninstall / install wheels
- ABGE Uninstalling / installing cover

- 1 Connector
- 2 Hoses
- 3 Screws
- 4 Hose clamps

- ➔ Disconnect the connectors.
- ➔ Unscrew the screws.
- ➔ Loosen the hose clamps.
- ➔ Pull out the hoses.

Installation information

Check the O-ring.
Check for leaks.

ABRD Uninstalling / installing the control valve steam volume



- ABRD Uninstall / install wheels
- ABGE Uninstalling / installing cover

- 1 Turning handle
- 2 Screws
- 3 Control valve steam volume
- 4 Hose clip
- 5 Hose

- ➔ Pull off the rotary handle.
- ➔ Unscrew the screws.
- ➔ Loosen the hose clamps.
- ➔ Pull off the hose.
- ➔ Remove the control valve steam volume.

Installation information

- Check the O-ring.
- Check for leaks.

ABRW Uninstalling / installing the control valve water volume

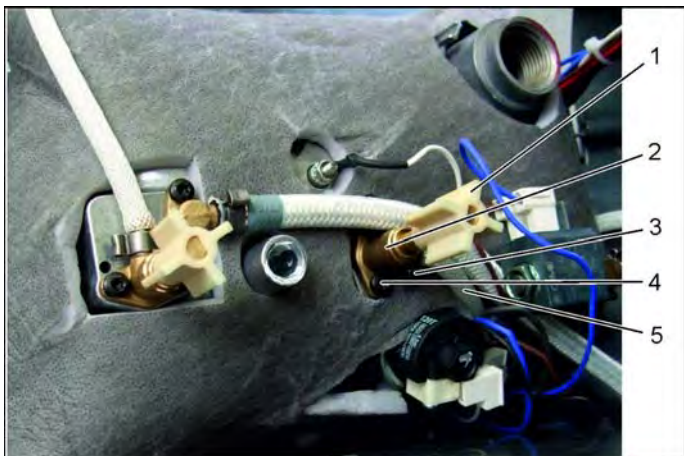

- ABRD Uninstall / install wheels
- ABGE Uninstalling / installing cover

- 1 Turning handle
- 2 Valve
- 3 Hose clip
- 4 Screws
- 5 Hose

- ➔ Pull off the rotary handle.
- ➔ Unscrew the screws.
- ➔ Loosen the hose clamps.
- ➔ Pull off the hose.
- ➔ Replace the valves

Installation information

- Check the O-ring.

ADTH Uninstalling / installing thermostat

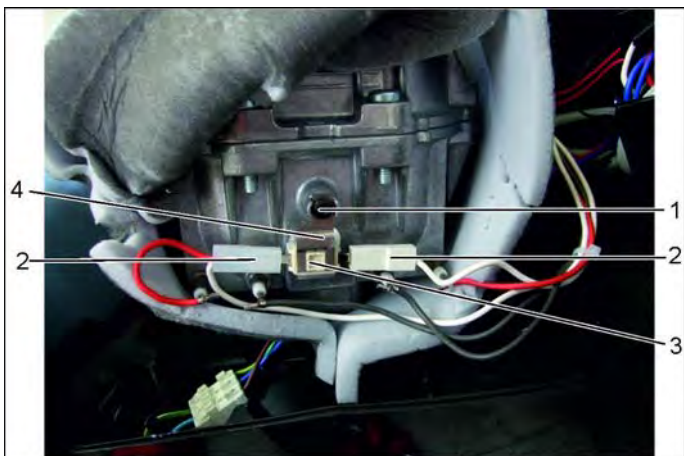

- ABRD Uninstall / install wheels
- ABGE Uninstalling / installing cover

- 1 Screw
- 2 Connector
- 3 Thermostat
- 4 Halting plate

- ➔ Disconnect the connector.
- ➔ Loosen the screw.
- ➔ Remove the retaining plate.
- ➔ Remove the thermostat.

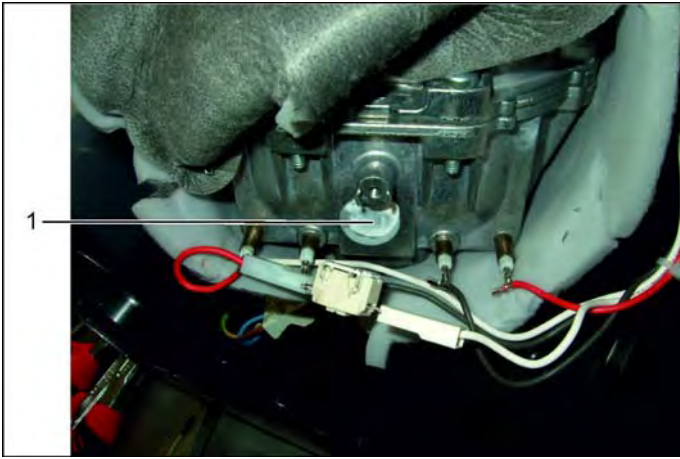

- 1 Heat-conducting paste
- ➔ Renew heat-conducting paste.

ADTW Uninstall / install water shortage thermostat

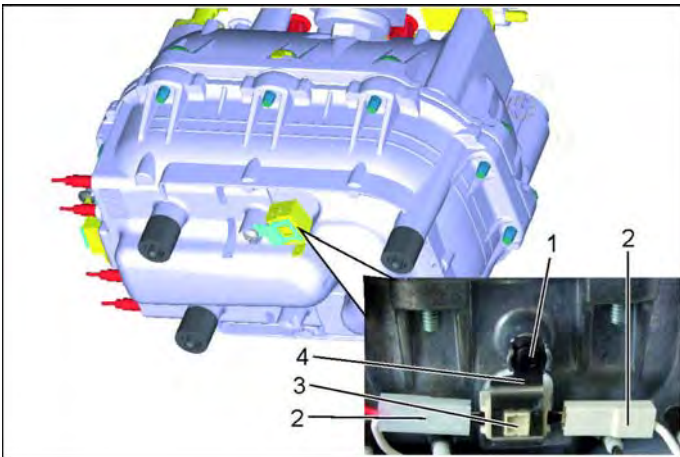

- ABRD Uninstall / install wheels
- ABGE Uninstalling / installing cover

- 1 Screw
- 2 Connector
- 3 Thermostat
- 4 Halting plate

- ➔ Disconnect the connector.
- ➔ Loosen the screw.
- ➔ Remove the retaining plate.
- ➔ Remove the thermostat.

ADWF Uninstalling / installing water filter

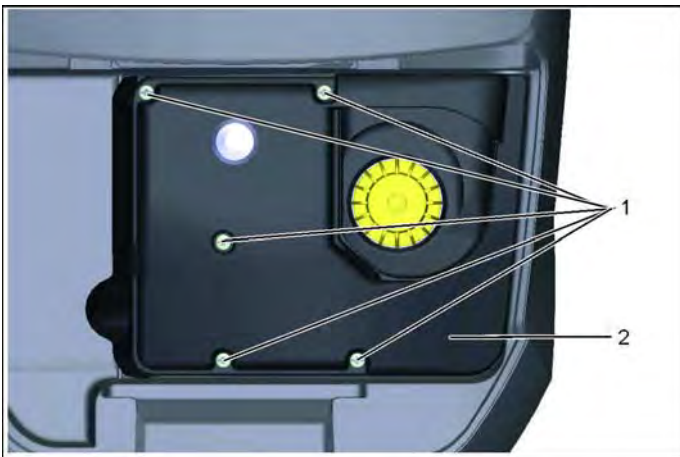

- 1 Screws
- 2 Cover
- ➔ Unscrew the screws
- ➔ Remove the lid.

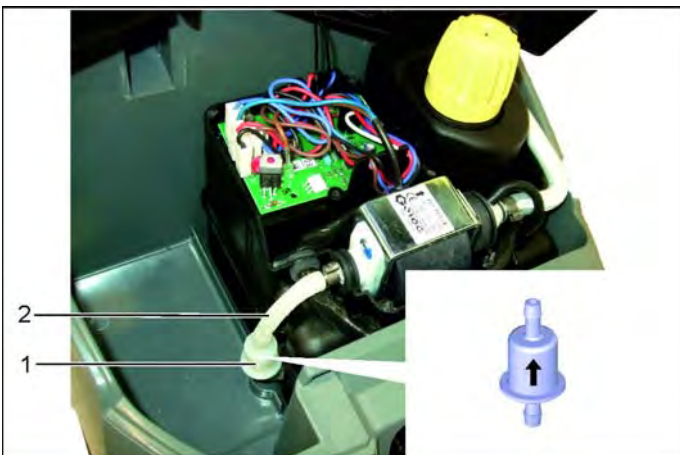

- 1 Water filter
- 2 Hose
- ➔ Pull out the hoses.
- ➔ Remove water filter.

Installation information
Mind the fitting position of the filter.

ADWP Uninstall / install water pump

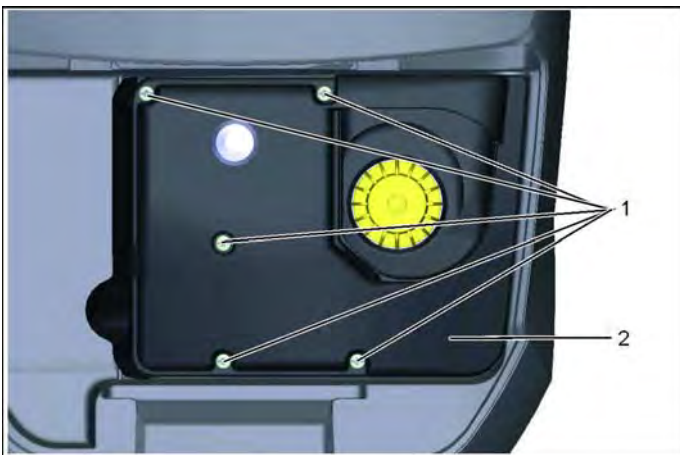

- 1 Screws
- 2 Cover

- Loosen screws.
- Remove the lid.

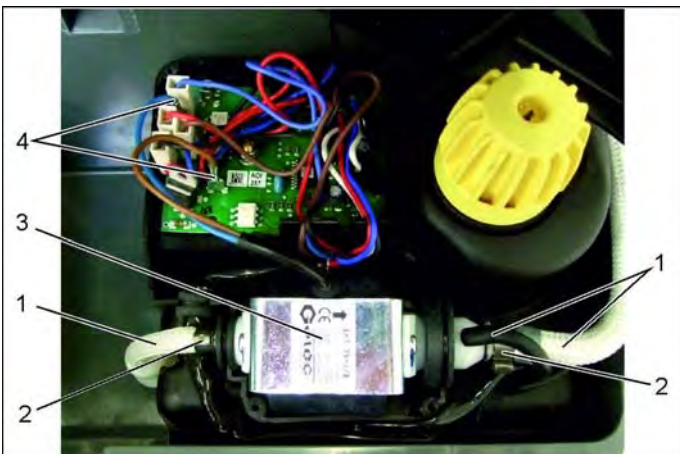

- 1 Hose
- 2 Hose clip
- 3 Water pump
- 4 Connector

- Disconnect the connectors.
- Loosen the hose clamps.
- Pull out the hoses.
- Uninstall water pump.

Installation information

- Renew hose clips.
- Check for leaks.

050 Maintenance and inspection

Service group does not contain any maintenance and inspection points.

060 Error diagnosis

The service group does not contain any error diagnosis.

070 Peculiarities/ others

The service group does not contain any peculiarities.

AH Service group electrics

010 Safety information

⚠ WARNING

Prior to all work on the appliance, switch off the appliance and pull the power plug.

Allow the appliance to cool down prior to performing service tasks.

Relieve the high pressure system of all pressure prior to all work on the appliance and the accessories.

Observe general safety information!

020 Overview

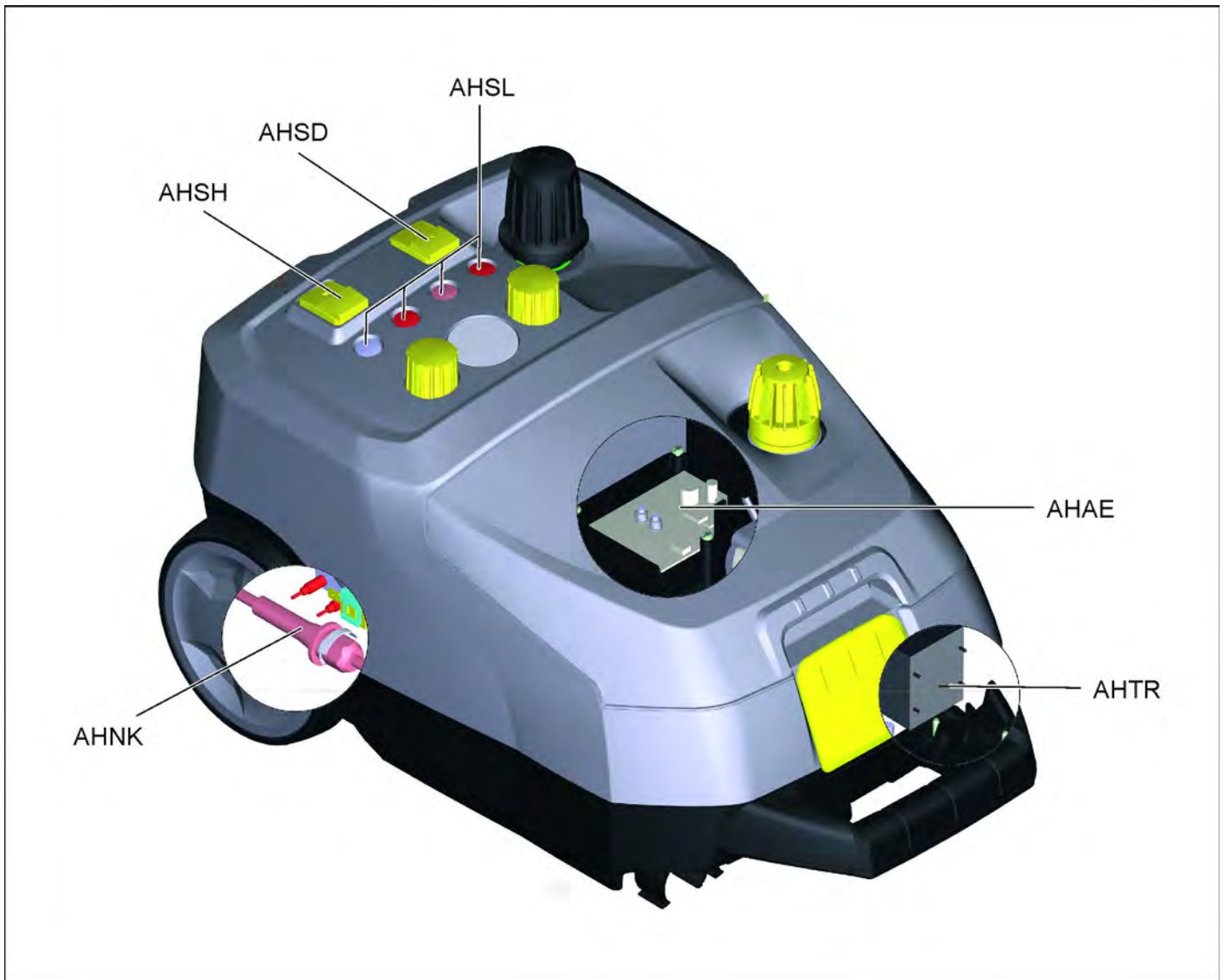

AHNK Uninstalling / installing mains connection

AHSD Uninstalling / installing switch for steam supply

AHKL Uninstalling / installing indicator lights

AHTR Uninstalling / installing transformer

AHAE Uninstalling / installing switch-off electronics

030 Function

No special functional characteristics.

040 Service activities

AHNK Uninstalling / installing mains connection

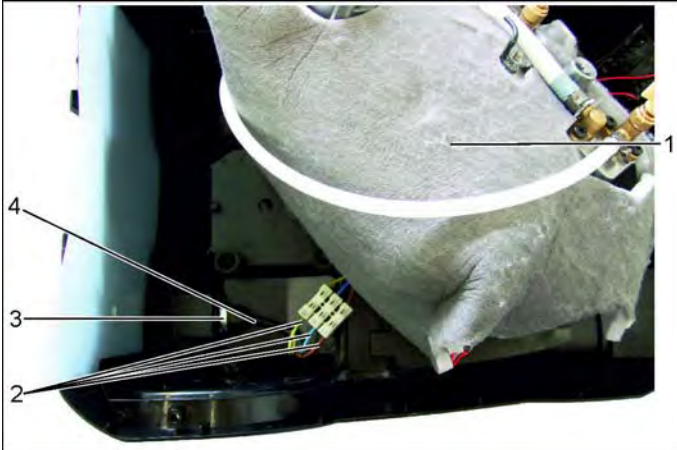

- ABRD Uninstall / install wheels
- ABGE Uninstalling / installing cover

- 1 Pressure container
- 2 Pipes
- 3 Safety clip
- 4 Mains connection

- ➔ Put pressure tank aside.
- ➔ Disconnect lines.
- ➔ Pull out the safety clip.
- ➔ Pull out the mains connection.

AHSD Uninstalling / installing switch for steam supply

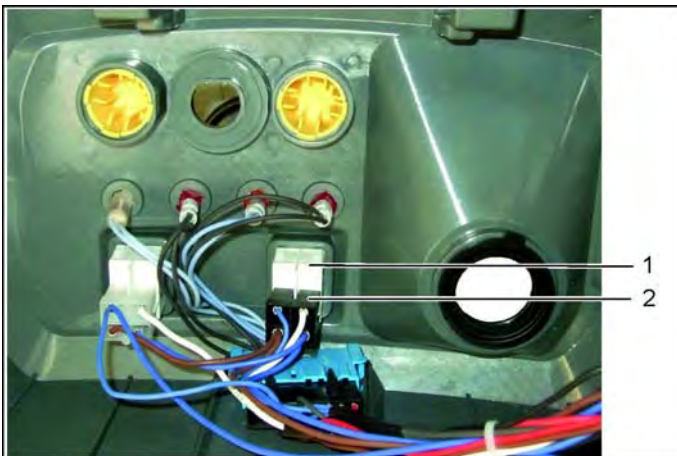

- ABRD Uninstall / install wheels
- ABGE Uninstalling / installing cover

- 1 Switch
- 2 Connector

- ➔ Disconnect the connectors.
- ➔ Unlock the switch.
- ➔ Remove the switch.

AHSH Uninstalling / installing switch for heating

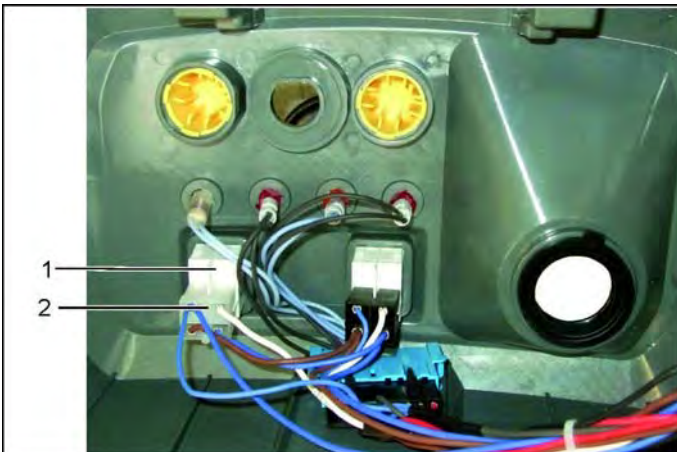

- ABRD Uninstall / install wheels
- ABGE Uninstalling / installing cover

- 1 Switch
- 2 Connector

- ➔ Disconnect the connectors.
- ➔ Unlock the switch.
- ➔ Remove the switch.

AHKL Uninstalling / installing indicator lights

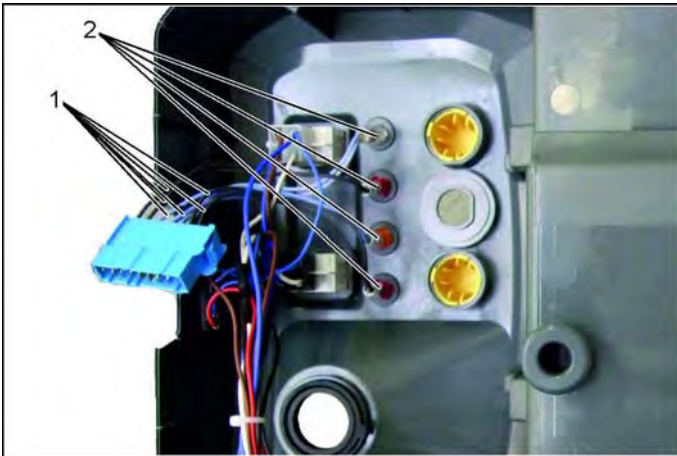

- ABRD Uninstall / install wheels
- ABGE Uninstalling / installing cover

- 1 Plug connections
- 2 Indicator lamps

- ➔ Disconnect the connectors.
- ➔ Remove indicator lights.

Perform a function test.

AHTR Uninstalling / installing transformer

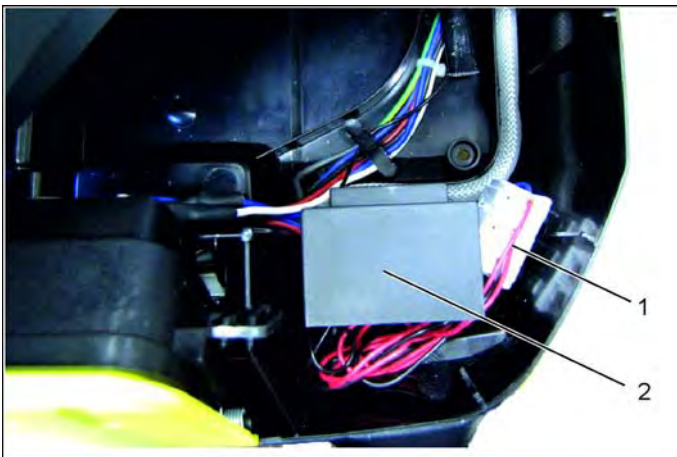

- ABRD Uninstall / install wheels
- ABGE Uninstalling / installing cover

- 1 Connector
- 2 Transformer

- ➔ Disconnect the connector.
- ➔ Remove transformer.

Installation information

Lay lines free of kinks.
Mind correct installation of the lines.

AHAE Uninstalling / installing switch-off electronics

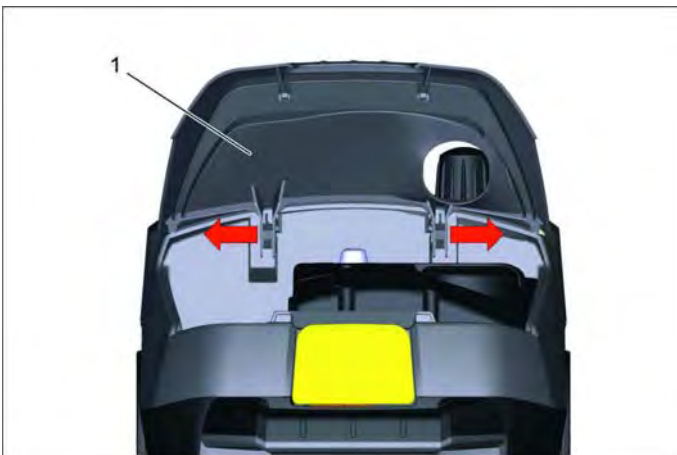

- 1 Hood

- ➔ Remove the hood.

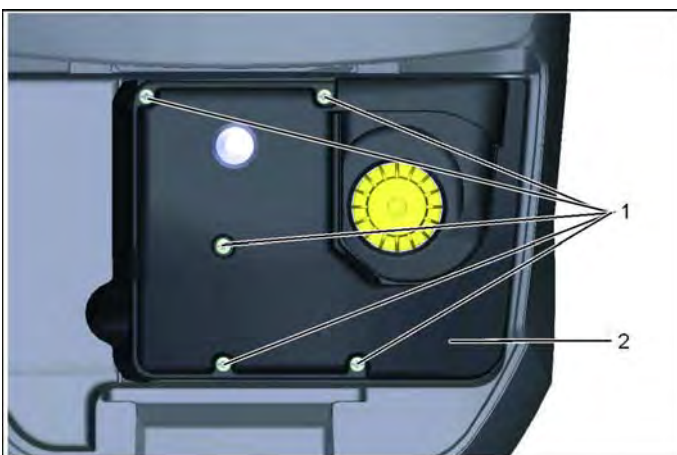

- 1 Screws

- ➔ Unscrew the screws

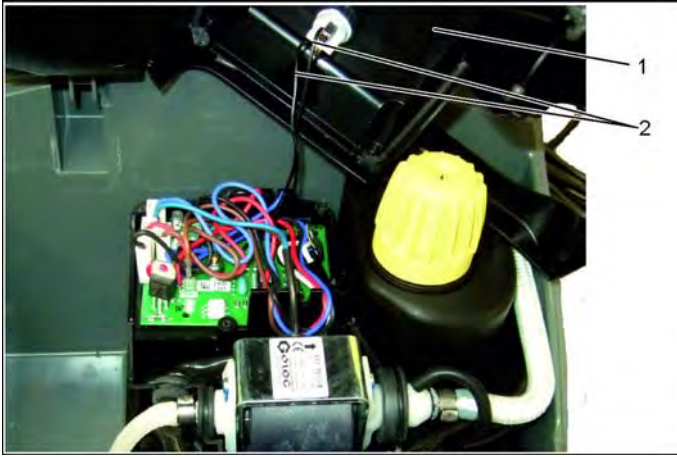

- 1 Cover
- 2 Pipes

- ➔ Lift the cover.
- ➔ Disconnect lines.
- ➔ Remove cover.

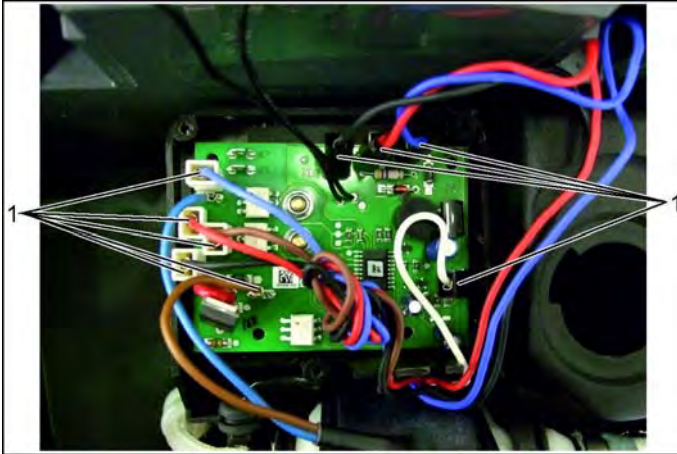

- 1 Plug connections

- ➔ Disconnect the connectors.

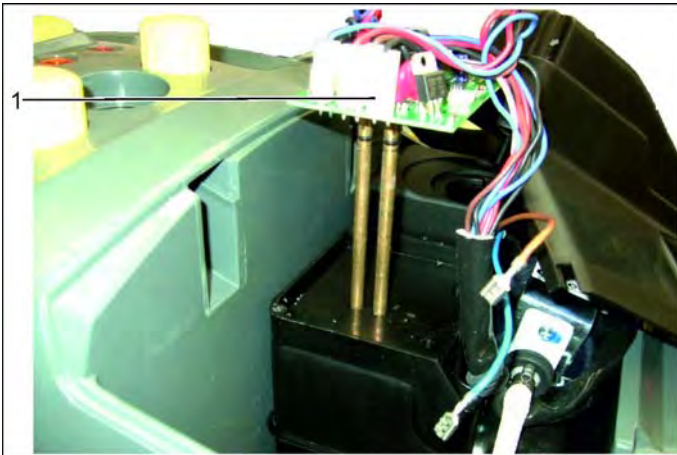

- 1 Printed board

- ➔ Remove the board from the casing.

Installation information

Check O-rings for damage.
Observe the plug arrangement during installation.

050 Maintenance and inspection

Service group does not contain any maintenance and inspection points.

060 Error diagnosis

The service group does not contain any error diagnosis.

070 Peculiarities/ others

The service group does not contain any peculiarities.

Technical specifications

Electrical connection		
Mains voltage	V	220-240
Frequency	Hz	1~ 50-60
Voltage in the steam gun	V	24
Type of protection	--	IPX4
Protective class	--	I
Performance data		
Heating output	W	2300
Pump	W	50
Max. operating pressure	MPa (bar)	0,4 (4,0)
Permitted operating pressure	MPa (bar)	0,6 (6,0)
Max. work temperature	°C	145
Heating time per litre of water	min	approx. 4.5
Steam quantity (max.)	g/min	82
Dimensions and weights		
Typical operating weight	kg	8,0
Max. water capacity	l	4,0
Tank content	l	2,0
Boiler capacity	l	2,4
Length x width x height	mm	475 x 320 x 275

Circuit diagram

When working on the device, please always use the current circuit diagram in DISIS.

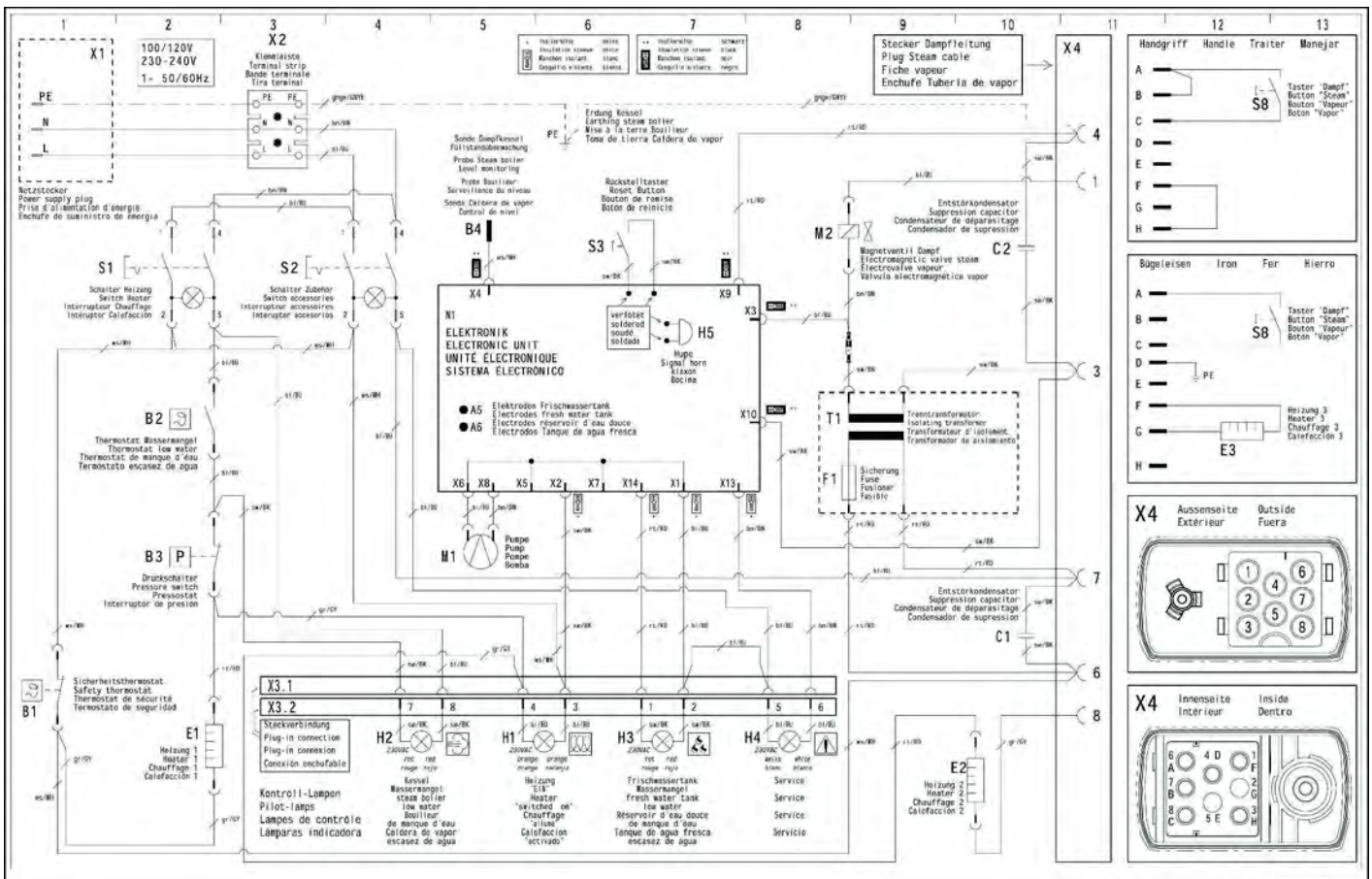

Troubleshooting

Failure	Cause	Remedy
Safety interlock cannot be opened	Pressure in the pressure tank too high	Release pressure, operate steam gun.
Safety interlock cannot be opened	Safety lock defective	Replace defective parts.
No steam exits the steam gun	Steam switch on the gun defective	Replace the switch
No steam exits the steam gun	Transformer, cable, heating, solenoid valve defective.	Replace defective parts. <i>AHTR Uninstalling / installing transformer</i> <i>AHMK Uninstalling / installing mains connection</i> <i>Replace the thermostat</i> <i>ADMA Uninstall / install solenoid valve</i>
Steam volume cannot be regulated	Control valve steam volume defective	Check the control valve steam volume. Replace defective parts. <i>ADRD Uninstalling / installing the control valve steam volume</i>
The moisture of the steam cannot be regulated (VAPOHYDRO system)	VAPOHYDRO control valve defective	Replace valve. <i>ADRW Uninstalling / installing the control valve water volume</i>
The indicator light for water shortage is always on	Thermostat defective	Replace the thermostat <i>ADTW Uninstall / install water shortage thermostat</i>
Safety lock has opened	Pressure regulator defective	Check / replace the pressure regulator <i>ADDR Uninstalling / installing the pressure regulator</i>
Safety lock has opened	Safety lock defective	Replace the safety lock
Thermostat has switched the device off	The pressure regulator or thermostat water shortage is defective	Replace pressure regulator or thermostat water shortage <i>ADDR Uninstalling / installing the pressure regulator</i> <i>ADTW Uninstall / install water shortage thermostat</i> Check electrical system.
Appliance does not heat up	Heating, mains connection, thermostat, switch heating, switch steam supply, thermostat water shortage defective	Replace defective parts. <i>AHMK Uninstalling / installing mains connection</i> <i>ADTH Uninstalling / installing thermostat</i> <i>AHSH Uninstalling / installing switch for heating</i> <i>AHSD Uninstalling / installing switch for steam supply</i> <i>ADTW Uninstall / install water shortage thermostat</i>
No temperature indication	Temperature indicator defective	Replace temperature indicator.

Failure	Cause	Remedy
Pump does not deliver water	Level sensor in the pressure tank furred up Water pump defective. Electrical connections interrupted.	Descale level sensor and pressure tank. Check the electrical connections. Replacing the pump <i>ADWP Uninstall / install water pump</i>
Indicator light "Descaling" is on	Pressure tank furred up.	Descale the pressure tank. Press the reset key until the indicator lamp "Descaling" goes off.

Measured values

010 Safety information

-DANGER

Dangerous voltages on mains potential are applied to the entire board.

Work on electrical components may only be performed by a certified electrician.

Observe general safety information!

Printed board

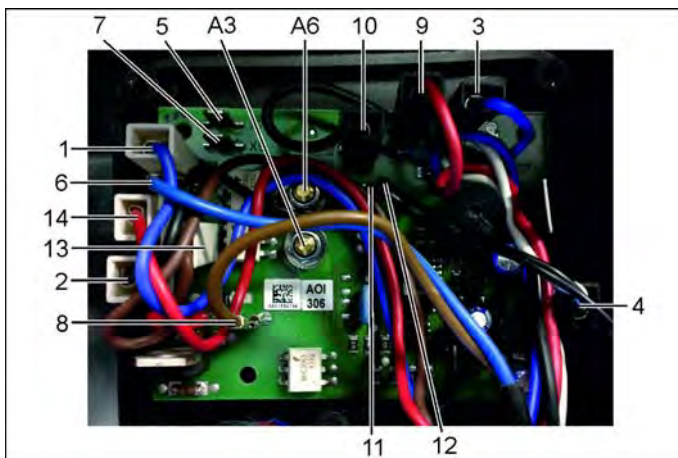

	Plug	Function
1	X1	Indicator lamp "water shortage" red Mass
2	X2	Indicator lamp - heating (yellow)
3	X3	Solenoid valve Steam
4	X4	Probe steam valve filling level monitoring
5	X5	Mass
6	X6	Connecting piece Pump Mass
7	X7	Mass
8	X8	Connecting piece Pump
9	X9	Low-voltage supply
10	X10	Low-voltage supply
11	X11	Reset key - Descaling
12	X12	Reset key - Descaling
13	X13	Indicator lamp - Descaling (white)
14	X14	Indicator lamp "water shortage" red
15	X15	Plug steam hose with pushbutton
	A3	Switch-off electronics
	A6	Switch-off electronics

Plug



Voltage measurement

The first specification refers to the voltage input and the second to the COM input on the measuring device.
(e.g. pin 1 + pin 2 --> voltage input at pin 1 and COM input at pin 2).

Here the mains voltage is defined as the provided voltage in the relevant country (+/- 10%).

CAUTION

The following measurements may only be performed by a certified electrician.

Measurements with connection to mains voltage

Measurement	Component	Nominal measuring value	
X1 + X5 + X6 + X7	Earth on the PCB	< 1 VAC	
X11 + X12	Reset key - Descaling	0 VDC	Switch 3 operated
		5 VDC (+/- 20%)	Switch 3 not operated
X2 + X1	Indicator lamp - heating (yellow)	0 VAC	Switch 2 not operated
		Mains voltage	Switch 2 operated
X8 + X6	Supply of the pump	0 VAC	Pump off
		194 VAC (+/- 20%)	Pump on
X13 + X1	Indicator lamp - Descaling (white)	0 VAC - 50 VAC	Indicator light off
		Mains voltage	Indicator light on
X14 + X1	Indicator lamp "water shortage" red	0 VAC - 50 VAC	Indicator light off
		Mains voltage	Indicator light on
X3/X9 + X10	Low-voltage supply	0 VAC	Switch 2 not operated
		30 VAC (+/- 20%)	Switch 2 operated

Measurements without connection to mains voltage

Measurement	Component	Nominal measuring value	
A3 + A6	Resistor	< 50k Ohm	Water in the tank
X15 pin1 + X15 pin3	Perform the continuity test.	Continuity	Switch pressed
		No continuity	Switch not pressed