

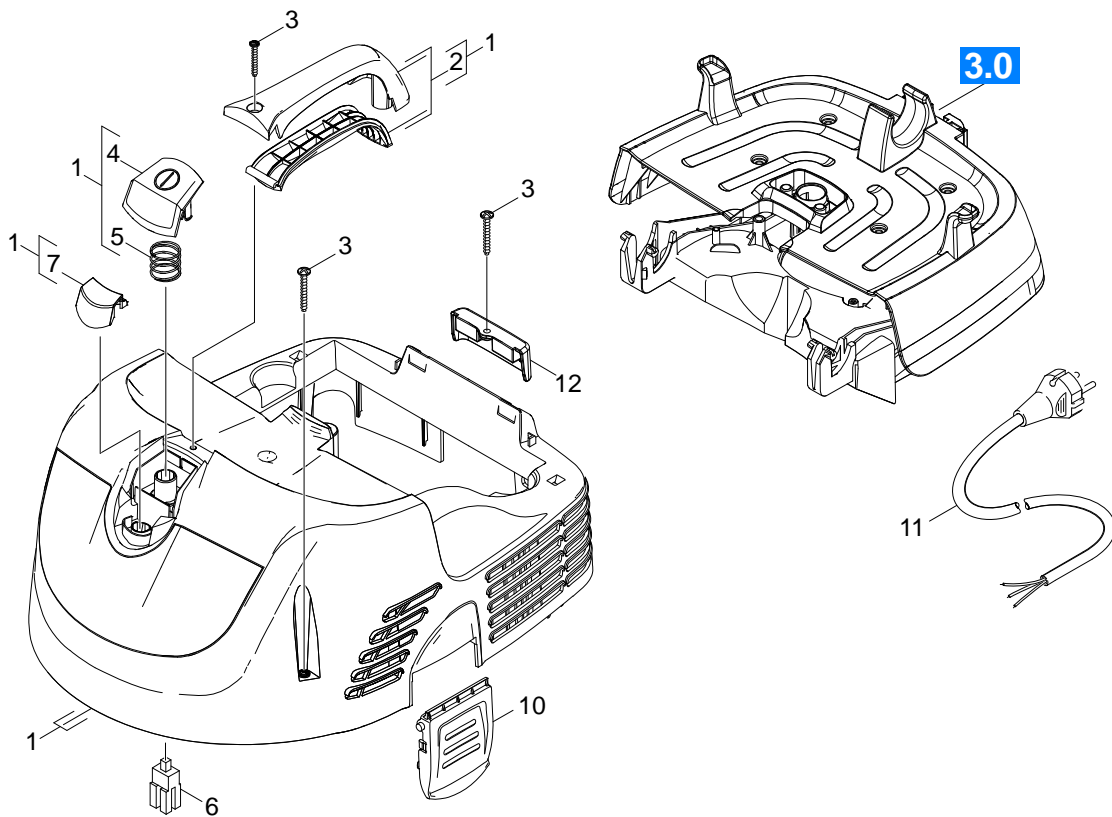













.. \.. \.. \.. \.. \.. \.. \10 Крышка (0.165-536.0)

Nicht positionierte Bauteile sind keine Ersatzteile



| | ЗЧ/БЧ | Поз. | Материальный № | Обозначение | Количество | Единица | Сведения о варианте |
|---|---|------|----------------|---|------------|---------|---------------------|
|  | | 1 | 4.066-399.0 | Крышка комплектный только для замены NT | 1.000 | ST | |
|  | | 2 | 4.321-213.0 | Рукоятка в сборе только на замену | 1.000 | ST | |
|  |  | 3 | 7.303-086.0 | Винт 5x30 -10.9-R2R (K-In6Rd) | 5.000 | ST | |
|  |  | 4 | 5.324-124.0 | Кнопка вкл/выкл RAL 1018 | 1.000 | ST | |
|  |  | 5 | 5.332-934.0 | Пружина микропереключатель вкл./выкл. | 1.000 | ST | |
|  |   | 6 | 6.630-437.0 | Переключатель вкл/выкл PUZZI | 1.000 | ST | |
|  | | 7 | 5.324-149.0 | Микропереключатель закрытый | 1.000 | ST | |
|  |   | 10 | 5.033-256.0 | Накладка замок | 2.000 | ST | |
|  | | 11 | 6.647-263.0 | Кабель с вилкой *EUR 7,5 м | 1.000 | ST | *EU |
|  | | 12 | 5.033-744.0 | Кожух | 1.000 | ST | |