

TASKI
Diversey

swingo 2500/3500

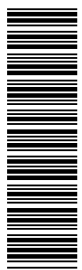
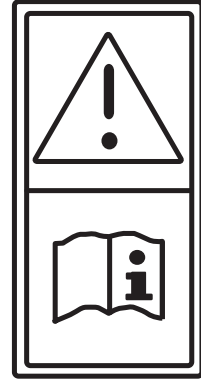

V006 / 12089-04 1005

tr sv pt pl no nl it fr fi es en de cz

Translation of the original Instructions of Use



ATTENTION!

Before the first start-up, it is essential that you carefully read the instructions of use and the safety notes.

Keep the instructions of use in an easily accessible place so that they can be consulted at any time.

Symbols



Indicates important information, which, if not complied with, could endanger people and / or cause severe damage!



Non-observance of this information can lead to malfunctions and property damage!



Indicates important information about economical use. Non-observance of this information could lead to malfunctions!

- Marks work steps that you must carry out in turn.

Intended use of machinery

TASKI swingo 2500/3500 are scrubber dryers that have been designed for commercial use (for example, in hotels, schools, hospitals, factories, shopping centres, offices, etc.).

Under strict observation of the instructions of use, it can be used for the wet cleaning of hard floor coverings.

These machines are exclusively designed for indoor use only.



Caution:

These machines must not be used for polishing, the application of wax, cleaning carpets or the vacuuming up of dust. The wet cleaning of parquet and laminate floors with this machine is carried out at your own risk.



Changes to the machines that have not been authorised by Diversey will lead to the cancellation of the Safety Marks and the CE conformity. Any use of the machines contrary to their intended purpose can lead to injuries to persons and damage to the machine and to the working environment. In such cases, any claims under the guarantee and warranty claims will normally become invalid.

Content

Safety instructions	22
Translation of the original EC Declaration of Conformity	23
Overview	24
Preparation for operation/Operation	25
Beginning work	26
End of operation	27
Service, maintenance and care	29
Squeegee setting for the swingo 3500	30
Malfunctions	30
Technical data	31
Accessories	31
Transport	31
Disposal	31

Safety instructions

Due to their design and construction, TASKI machines comply with health and safety requirements of the EC guidelines and therefore carry the CE sign.



This appliance may not be safely used by persons (including children) with reduced physical, sensory or mental capabilities or who lack experience and knowledge, unless they are supervised or instructed by a responsible person!

Children should be supervised to ensure that they do not play with the appliance.



Do not use the machine in rooms where explosive and flammable substances (e.g. petrol, thinners, heating oil, solvents, etc.) are stored or processed. The electrical or mechanical components of the machine could lead to ignition of these materials.



Do not use this machine to vacuum toxic, poisonous, caustic or irritating substances (e.g. hazardous dusts, etc.). The filter system will not adequately retain these kinds of materials. A possible impairment of the health of the user and of third parties cannot be excluded.



The machine may only be used by persons who have been suitably instructed in its use.



While operating the machine, take note of the surrounding area and pay particular attention to third parties and children!



The machine is designed to carry one person, no second person may be transported!



In case of damage to parts that could affect safety, such as the tool cover, power supply cord or covers that prevent access to current-carrying parts, the operation of the machine must be stopped immediately!



In the case of a malfunction or a defect in the machine (such as the jamming of the gas pedal), or if the machine is dropped or damaged in some other way, the machine must be thoroughly checked by a TASKI specialist before being put back into service again. The same applies if the machine is left out in the open, or if any parts of the machine become immersed in water or are exposed to dampness.



Caution:

Repairs to mechanical or electrical parts of the machine must only be undertaken by customer service workshops or experts authorised by Diversey, who are experienced in all relevant safety regulations.



Caution:

This machine is only intended for use in dry areas, and must not be used or stored in the open air or under damp conditions.



Caution:

Pay attention to the accident prevention regulations!



Caution:

Switch off the suction unit immediately if foam or liquid escape from the machine!

See page 30 for further procedure .



Caution:

Only use the tools that are defined in these instructions of use under Accessories or that have been recommended by the TASKI specialist (page 31), as other tools could impair the safety of the machine.



Caution:

The protection of persons is based on the special national regulations and the information from the detergent producer!



Caution:

This machine may not be operated without batteries!

**Caution:**

The batteries may only be charged using a battery charger that has been tested to the latest state-of-the-art according to EN 60335-2-29!



Only use the machine on level floors or on gradients of 13% or less.

This symbol on the machine indicates that it is not suitable for use on surfaces with large gradients or slopes.

Important! Switch the machine off when you:

- e.g. carry out cleaning or maintenance work, or convert the machine to another function
- store it in a suitable room to avoid any unauthorised use of the unit
- leave it standing without supervision

You should also remove the key from the key switch and prevent the machine from rolling away (for example, by activating the parking brake).



The tank hood must be closed when moving or driving the machine.

Store the machine in a dry, dust-free room with a corrosion-free atmosphere.

The temperature must not fall below +10 °C or exceed +35 °C. Low temperatures, damp and dust can significantly reduce the service life of the electrical components.

**Noise emissions and vibrations:**

TASKI machines and units have been designed so that any danger to health through the noise emitted or through vibrations can be excluded according to the current state of knowledge. Refer to the technical information on page 31.

Translation of the original EC Declaration of Conformity

We hereby declare that the product described below conforms to the relevant safety- and health-related requirements of the appropriate EU Directive in both its basic design and construction and in the version marketed by us. If any modifications are carried out on the product that have not been agreed with us, this declaration will no longer be valid.

Designation: **Automatic machine for the treatment of floors for commercial purposes.**

Product: **scrubber dryer**
 Model: **swingo 2500/3500**
 Model: **CO2500 (24VDC/20000W)**
 Model: **CO3500 (24VDC/20000W)**

Serial number: Refer to the rating plate on the machine

Trademark:



Manufacturer: Diversey, 9542 Münchwilen - Switzerland

Applicable EC Directives:

Directive 2006/42/EC of the European Parliament and of the Council dated 17th May 2006 regarding machines and for the modification of Directive 95/16/EC (new version)

Directive 2004/108/EC of the European Parliament and of the Council dated 15th December 2004 for the harmonisation of the legal regulations of the Member States regarding electro-magnetic compatibility and for the annulment of Directive 89/336/EEC

Harmonised standards applied:

EN 60 335-1/ EN 60 335-1+A11/ EN 60 335-1+A12/ EN 60 335-1+A13/
 EN 60 335-2-72:2 009/EN 62 233/
 EN 55 014-1:2007/ EN 55 014-2+A1/EN 61 000-3-2:2006/
 EN 61 000-3-3:1995+A1:2001+A2:2005

It is ensured through internal measures that series-production units conform at all times to the requirements of current EU Directives and relevant standards

Responsible for documentation:

Stephan Engler
 Diversey Europe B.V. Utrecht
 Münchwilen branch
 CH-9542 Münchwilen

Münchwilen, dated 01.03.2010

Dipl. Ing. (FH) D. Windmeisser
 Technical Director
 Floor Care Equipment

Dipl. Ing. (FH) P. König
 Value Chain Director
 Floor Care Equipment

The signatories act on behalf of company management and with full power of attorney.



Overview

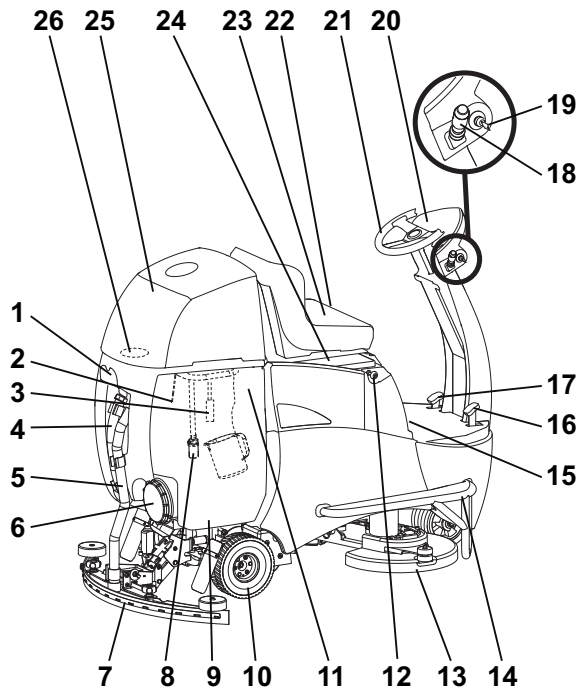

- 1 Tube holder
- 2 Full recovery tank probe
- 3 Recycling filter (optional)
- 4 Drainage hose
- 5 Suction hose
- 6 Tank lid
- 7 Squeegee
- 8 Solution supply pipe and filter
- 9 Recovery tank
- 10 Rear wheel steering unit
- 11 Solution tank (bag-in-tank) with dosing aid
- 12 Battery disconnection socket
- 13 Brush unit
- 14 Metal bumper
- 15 Parking brake
- 16 Drive pedal
- 17 Brake pedal
- 18 Drive / reverse lever and horn
- 19 Keyswitch
- 20 Control panel
- 21 Steering wheel
- 22 Driver seat with adjustment lever
- 23 Driver seat with safety contact
- 24 Battery cover (main fuse and battery plug)
- 25 Tank hood
- 26 Suction filter

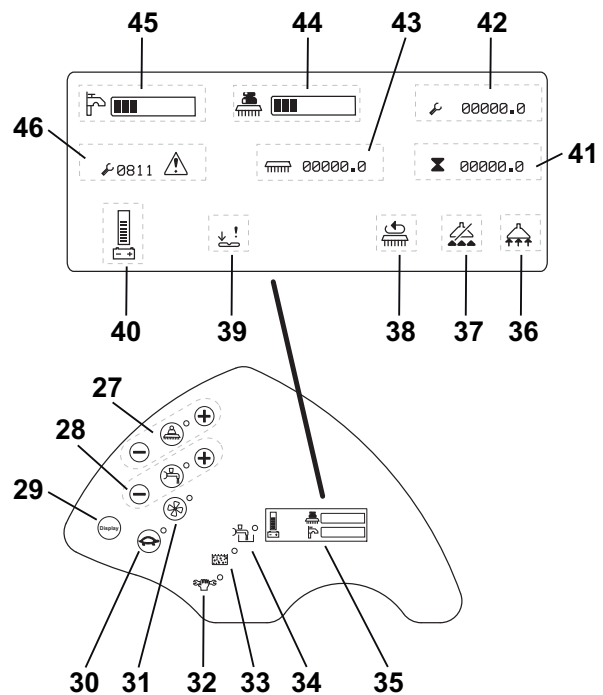

- 27 Brush button (+/- for pressure)
- 28 Solution button (+/- for quantity)
- 29 Display control button
- 30 Slow speed button
- 31 Suction unit button
- 32 Service indicator
- 33 Recovery tank full indicator
- 34 Empty cleaning solution indicator
- 35 Display screen when turning on
- 36 Suction aggregate on
- 37 Suction aggregate off (recovery tank full)
- 38 Tool aggregate on
- 39 Pedal error indicator
- 40 Battery indicator
- 41 Hour counter
- 42 Service hour counter
- 43 Tool aggregate hour counter
- 44 Brush pressure display
- 45 Solution level display
- 46 Error code

Preparation for operation/Operation

Batteries

Safety measures when working with batteries:



- Protective goggles must be worn when working on the batteries.



- Do not subject batteries to an open flame or heat as there is a danger of explosion from the electrolytic gas present in the cells!



- No smoking!



- Danger of chemical burns!



Caution:

The battery must always be clean and dry. Do not place any metallic objects on the battery.



Caution:

Batteries may only be installed or dismantled by customer service personnel or specialists approved by Diversey who are aware of all the safety regulations that apply here!



Caution:

Please follow the instructions of use for your battery charger!



Caution:

Battery compartment must be open during charging.



Caution:

When maintenance of batteries takes place, they must be disconnected from the machine!

Recharging procedure using an external battery charger (traction block batteries and rechargeable batteries)

- Pull out the key and apply the parking brake (refer to page 25).
- Push the driver seat forward so that it rests on the steering wheel, and open the battery cover.
- Disconnect the battery from the machine using the battery disconnection socket.
- Connect the battery plug with the external battery charger.

After completing the charging and with immediate use:

- Switch off the battery charger.
- Disconnect the battery charger.
- Connect the battery to the machine with the battery disconnection socket.
- Fold back the driver's seat.

Maintenance of batteries (wet batteries)

Daily, after charging:

- Measure the acidity in 3 or 4 cells.
It should be approx 30°.
The battery is discharged when the acidity reduces to approx. 18°.
- Please note the measurements into the battery booklet.
- Please check the electrolyte, and if needed, fill it with distilled or desalinated water up to 10mm above the separators.

Monthly after charging:

- Measure the acidity in every cell.
- Please note the measurements into the battery booklet.
- Check:
-Connectors, cables, cable attachments and that the poles are screwed in tightly.

Preparation for use after charging:

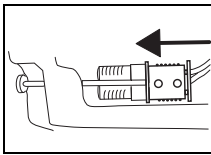

Closing battery compartment:

- Reconnect the battery plug to the machine.
- Re-cover the battery compartment and return the driver seat into its normal position.

Parking brake

Locking:

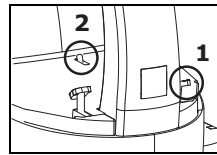

- First press down the brake pedal (1) and then the parking brake (2).
Release the brake pedal, and the machine is locked.

Unlocking:

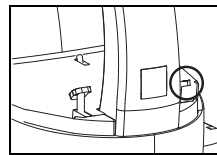

- Press the brake pedal fully down.
The machine is unlocked.

Adjust the seat

- Pull out the key and apply the parking brake (refer to page 25).
- Pull the lever on the left side of the driver's seat and slide to the desired position.
- Push the lever back in, once the seat has been corrected.
Check the seat locking device!

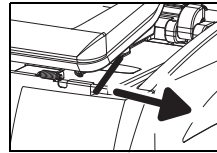

- Unlock the parking brake (refer to page 25).

Driving

The driving direction and speed can be controlled with the steering wheel and drive pedal, the speed is easily adjusted with varying amounts of pressure to the pedal.

- Unlock the parking brake (refer to page 25).
- Switch on the keyswitch.

The display lights up.

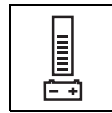

The battery indicator displays that the machine is ready for operation (in case of malfunction, refer to page 30).

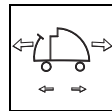

- Choose the driving direction by using the drive / reverse lever.

- Drive the machine to its destination and then release the drive pedal.

Attaching tools

- Pull out the key and apply the parking brake (refer to page 25).

Check:

- that the brushes are not below the red marking and that the bristle length is no less than 1 cm.
- the pad for wear before using.



Working with worn out, damaged and or wrong tools, could result in possible damage to floors or their protective layers.

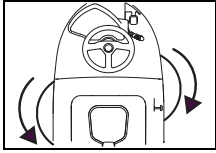

- Raise the tool up to the clutch.
 - Turn the left tool anti-clockwise and the right tool clockwise into the brush unit.
- You will feel the tools locate into place, at which point they are coupled with the unit.*

Attach squeegee

- Pull out the key and apply the parking brake (refer to page 25).

swingo 2500

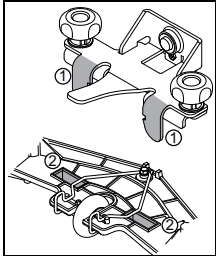

- Hold the squeegee with both hands, and position it so that the squeegee holding clips (1) fit into the squeegee cutouts ((2).

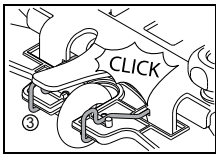

- Push the squeegee upwards until you hear the locking bracket (3) latch into place

- Plug the two suction hoses into the squeegee.

swingo 3500

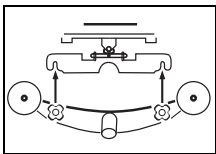

- Loosen the fixation knobs on the squeegee.
- Assemble the squeegee and tighten the fixation knobs.

- Attach the suction hose to the squeegee.

Filling the solution tank



Caution:
Maximum permissible water temperature 60 °C/140 °F.

- Pull out the key and apply the parking brake (refer to page 25).
- Push the driver seat forward so that it rests on the steering wheel, and open the tank hood.
- Take the dosing aid out of the solution tank (Flextank).

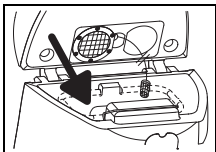

- Fill the solution tank (Flextank) with water.
The red line on the inside rim of the bag indicates maximum filling level.

Dosage:



Caution:
Wear protective gloves, goggles and the corresponding (protective) work clothing when handling chemical products!

Only use chemical products recommended by the manufacturer.



Caution:
Using other chemicals (e.g. chemicals containing solvents, chlorine, hydrochloric acid and hydrofluoric acid) can damage or destroy the machine.

The max. filling level in the tank corresponds to the quantity of the dosing aid.
Dosing examples (The concentration is product dependent)

Instructions on the product's packaging		Tank capacity	The volume per tank filling
0.5%	50 ml to 10 l water	95l	475ml = 0,475l
1%	100ml to 10 l water	95l	950ml = 0,95l
2%	200 ml to 10 l water	95l	1900ml = 1,90l
3%	500 ml to 10 l water	95l	4750ml = 4,75l

- Add the product measured with the dosing aid to the water in the solution tank (Flextank).
- Replace the dosing aid back in the tank.
- Close the tank hood and pull the drivers seat back into position.

Beginning work



Caution:
Always wear non-slip shoes and appropriate work clothing while working with this machine!

- Switch on the keyswitch.
The display lights up.



The cleaning settings last used will be saved and reloaded until you change them.

- Unlock the parking brake (refer to age 25).

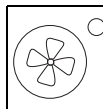

- Press the suction unit button.
The indicators light up.

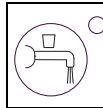

- Press the solution button.
The indicators light up.
- Choose the desired amount of solution with +/- (min. level 1/ max. level 7) .

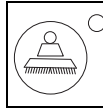

- Press the brush unit button.
The display lights up.

- Choose the brush pressure by using the +/- buttons (min. level 1 /max. level 4).

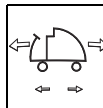

- Choose the driving direction by using the drive / reverse lever.



Caution:
Take the turning radius into account!

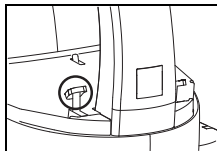

- By gently pressing the drive pedal, the machine is set into motion.
The tools start to turn and the solution is fed through the centre.



- Press the Slow run button if you are working in narrow or difficult environments.
The indicator lights up and the drive speed is reduced.

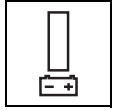

- If none of the bars in the battery indicator have lit up, drive the machine to the battery charging unit.

If no bar display lights up in the battery indicator:

- after 10 min. the tool aggregate and the squeegee will be lifted off the ground.
- the suction unit then turns itself off after a further 10 sec.
- you then have 10 min. left to get the machine to the battery charger before the machine turns itself off.

Recycling filter (optional)



Caution:

The recycling system is not to be used in areas with high hygienic demand e.g. hospitals, food-processing companies, kitchens, etc.

The recycling system is recommended for low to medium congested areas only.

- Pull out the key and apply the parking brake (refer to page 25).
- Push the driver seat forward so that it rests on the steering wheel, and open the tank hood.
- Pull the recycling filter out of the solution tank (Flextank).
- Place the recycling filter into the recovery tank.



Caution:

Maximum permissible water temperature 60°C/140°F.

Cleaning method

Direct method:

Scrubbing and vacuuming in one pass.

Indirect working method:

Apply the cleaning solution first (only scrubbing), afterwards scrubbing and vacuuming.

The cleaning methods are described in detail in the "Method Card". You can obtain this from your TASKI partner.



Under certain circumstances, the driving of the machine can be impaired by a special combination of surface/soiling and cleaning product.

This effect can be reduced by special wheel options.

Refilling the solution tank



Caution:

Do not clean without solution, as it could cause floor damage.

Solution tank empty indicator:

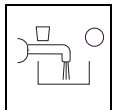

- When the cleaning solution tank empty indicator lights up, it is also accompanied by a tone.
Solution tank is empty.

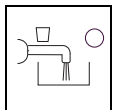

- Pull out the key and apply the parking brake (refer to page 25).
- Refill the machine, see page 26.
- Once the tank is filled, the solution tank empty indicator continues to stay lit.
- Drive the machine to a desired destination.

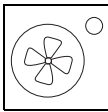

- Press the suction unit button.
The display lights up.

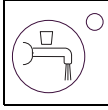

- Press the solution button.
The display lights up.

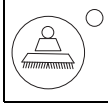

- Press the brush unit button.
The display lights up.

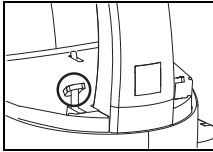

- Slowly press the drive pedal (approx. 5 sec.).
The solution tank empty indicator will thereby be reset.

Drain recovery tank

Recovery tank full indicator

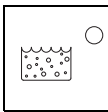

- When the recovery tank full indicator lights up, the squeegee will rise and the suction unit turns off.

- Drain the recovery tank, see below.

End of operation

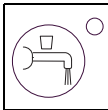

- Stop the flow of solution.

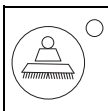

- Drive a few metres further to avoid subsequent dripping.

Very important when using contact pads!

- Press the brush unit button.
The tools will be stopped.
The tool holder rises up.

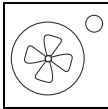

- Drive on a few metres further in order to pick up the remaining dirty water.

- Now switch off the suction unit.
The squeegee rises and the suction unit keeps on running for approximately 10 seconds.
- Drive to the drainage location.



Always drain and clean the recovery tank every time you use the machine.

If the soiled water is allowed to stand, unpleasant smells and the deposition of the dirt will take place after a few hours.

Drain the recovery tank / solution tank

The disposal of the soiled water or the cleaning solution must be carried out in accordance with the appropriate national regulations.



Caution:

Follow the national regulations and the information provided by the detergent manufacturer regarding the protection of persons when draining the tank.

- Pull out the key and apply the parking brake (refer to page 25).

Proceed as follows for both tanks:

- Remove the drain hose from its holder.



Hold the hose pointing upwards with the opening at the height of the edge of the tank. Open the red lid and slowly lower the end of the hose to the drain.

- Lift the solution tank (Flextank) and lay it into the recovery tank.
Cleaning solution is drained into recovery tank to then be removed.
- Remove the empty solution tank (Flextank) from the recovery tank.

Recovery tank draining pump (optional)

- Pull out the key and apply the parking brake (refer to page 25).

Emptying at a higher lever (e.g. sink):

- Place the draining hose into a sink or bucket.
- Press the recovery tank draining pump button.
The tank will be emptied up to the standpipe, some water will remain.

Clean the recovery tank / solution tank

- Pull out the key and apply the parking brake (refer to page 25).
- Push the driver seat forward so that it rests on the steering wheel, and open the tank hood.
- Unscrew the tank lid (page 24).
- Clean the recovery tank thoroughly with water.
- Screw the tank lid on with both hands.
- Thoroughly rinse out the solution tank (Flextank) with clean water.
- Remount the solution tank (Flextank) into its place.
- Remove any dirt from the full recovery tank probe.
- Brush the suction filter with a soft brush to remove fluff.

Recycling filter (optional):

- Take out the recycling filter after every use and clean.



Caution:
Clogged filters reduce the flow of the cleaning solution. As a consequence you may damage the floor coating.

- Place the recycling filter back in the solution tank (Flextank).

Removing and cleaning the tools

- Pull out the key and apply the parking brake (refer to page 25).
- Lift the tool lightly.

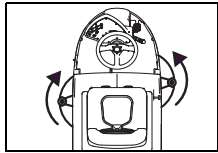

- Turn the left tool clockwise and the right tool anti-clockwise from the brush unit until they uncouple.

- Clean the tools with water.

Removing and cleaning the squeegee

- Pull out the key and apply the parking brake (see page 25).

swingo 2500

- Pull the two suction hoses from the squeegee support.
- Press the locking springs together. The squeegee will thereby be released and can be removed.

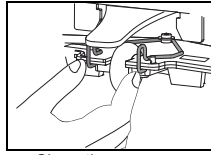

- Clean the squeegee under running water using a brush.
- Hang the squeegee on the tube/hose holder.

swingo 3500

- Remove the suction hose from the squeegee.
- Loosen the fixation knobs on the squeegee.
- Dismount the squeegee.

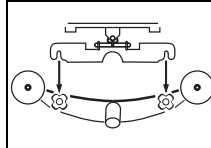

- Clean the squeegee under running water using a brush.
- Hang the squeegee on the tube/hose holder.



Only clean and intact blades will achieve an optimal result!

Cleaning the machine

- Pull out the key and apply the parking brake (refer to page 25).



Caution:
Never clean the machine with high water pressure or a water hose.

The ingress of water into the machine might cause considerable damage to mechanical or electrical parts.

- Wipe down the machine with a damp cloth.

Storage / parking of machine (machine is idle)



We recommend that you disconnect the battery from the machine using the battery disconnection socket when storing / parking the machine and when charging the battery.

Never store the machine with the tank hood closed.

- Pull out the key and apply the parking brake (refer to page 25).
- Push the driver seat forward so that it rests on the steering wheel, and open the tank hood.

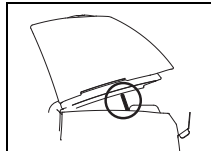

- Rest the tank hood on the metal support.
The ventilation support keeps the tank cover slightly open. In this way, the tank is kept dry and therefore reduces the formation of unpleasant smells and mould.



Caution:
Never store the machine for long period with a discharged battery. The battery could be damaged by this, and may no longer be functional.

Service, maintenance and care



Caution:
Only TASKI branded spare parts must be used, otherwise warranties and liabilities will be omitted!

The correct maintenance of the machine is a precondition for error-free operation and a long service life.

Symbols:
◇ = After use, ◇◇ = every week, ◇◇◇ = every month, ⊗ = Service light

Activity	◇	◇◇	◇◇◇	⊗	page
Recharge batteries	●				25
Refill distilled water (wet batteries). Please follow the manufacturers instructions of use booklet for these batteries!		●			25
Drain and clean the recovery tank	●				27
Clean the suction filter	●				30
Clean the recycling filter (optional)	●				28
Check solution supply pipe and filter and clean if necessary	●				24
Drain and clean the solution tank (Flextank) using fresh water	●				27
Clean the tools	●				28
Clean squeegee, check whether the blades are worn and replace if necessary	●				28
Clean the machine with a damp cloth	●				28
Clean the full recovery tank probe and check that it is functioning properly	●				
Clean seal of the tank hood, check for cracks and replace if necessary.		●			
Maintenance programs by TASKI service made by TASKI technician				●	

Service intervals

TASKI machines are high quality machines that have been checked for safety at the factory by authorised inspectors. Electrical and mechanical components are subject to wear and/or ageing after longer periods of use.

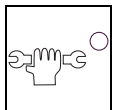

- In order to ensure operational reliability and availability for use, the service must be carried out when the service indicator lights up (factory setting 650 working hours) or at least once a year.

Shorter intervals may be necessary under rough or extreme working conditions and/or in case of insufficient maintenance.

Service centre

Should you contact us due to a malfunction or for placing an order, please always state the type, description and the serial number of your machine.

You can find this information on the name plate of your machine, and the address of your nearest TASKI partner can be found on the last page of this manual.

Blade change on the swingo 3500

Blade on the inner radius.

- Place the clean squeegee unit with the outer radius face down on a solid surface e.g. table, floor.
- Press one hand onto the squeegee body by the hose connector.
- Grasp the blade with your thumb and forefinger in the middle of the arch and pull strongly until the metal band clicks open and the blade is released from the squeegee body.
- Release the metal strap and pull the blade off the squeegee body.
- Clean squeegee (body, metal straps and blades) with a brush under running water.
- Mount the "turned" or the new blade on the squeegee body, so the ridges point outwards.
- Hook the metal strap into place (Check position of mounting slots) and press the centre of it until it clicks into place and presses the blade onto the squeegee body. (Risk of injury)

Blade on the outer radius

- Turn the squeegee upside down by placing it on its suction hose connector and the bumper wheels.
- Release the fixation screw of the blade holder using a screwdriver (Allen screw).
- Release the metal band and pull the blade off the squeegee body.
- Clean squeegee (body, metal straps and blades) with a brush under running water.
- Mount the "turned" or the new blade onto the squeegee body.
- Hook the metal strap into place (check position of mounting slots) and fix it with the screwdriver until the blade is pressed onto the squeegee body.
- The shape of the blades allow them to be used on all sides before needing replacement.

Replacing fuses

- Pull out the key and apply the parking brake (refer to page 25).
- Push the driver seat forward so that it rests on the steering wheel, and open the battery cover.
- Disconnect the battery from the machine using the battery disconnection mechanism.



Caution:
Use fuses with the correct value only!
Wrong fuses can cause damage to the machine.

Replacing main fuse:

- Loosen insulating nut (19mm spanner) of battery pole.
- Remove red insulating nut and detach the battery charger leads.

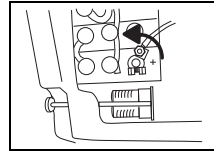

- Remove and replace main fuse.

Fuse ratings:	co 2500/3500
Main fuse	125A (Pudenz)

- Mount battery charger leads onto the battery pole and mount the insulating nut of battery pole.

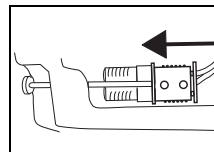

- Reconnect the battery plug to the machine.
- Re-cover the battery compartment and return the driver seat into its normal position.

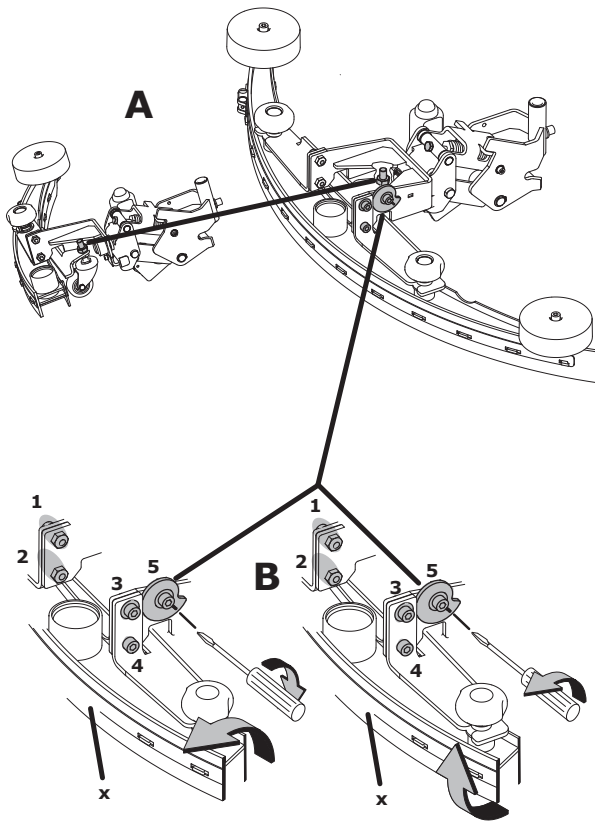

If you experience an uneven suction result, the settings of the squeegee should be corrected. Proceed as follows to do this:

Before carrying out the adjustment, check that:

- the blades are not damaged (replace).
- the suction unit is not damaged.

Height setting (Fig. A)

- Lower the squeegee.
- Pull out the key and apply the parking brake (refer to page 25).
- Unscrew the hexagonal nut.
- Turn the Allen screw left or right.

The distance between the floor and the running wheel (with the blades standing vertically) must be between 1-3 mm.

- Retighten the hexagonal nut.
- Check the result during the cleaning and refer to angle of inclination (Fig B).

Angle of inclination (Fig. B)

- Switch of the brush drive and the suction unit.
- Pull out the key and apply the parking brake (refer to page 25).
- Unscrew the Allen screws (nos. 1 to 4) on the suction unit adjustment (half a turn).
- Insert a screw driver into the slot in the cam and hold it in position while unscrewing the Allen screw No.5.
- Only change the angle of inclination in small steps using the cam.
- Keep the screwdriver in this position while tightening the cylindrical screws numbers 1 to 5.
- Check the result and correct it again if necessary.

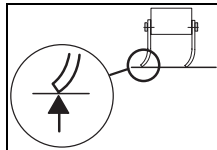

A correct angle has been achieved when the tip of the rear blade (x) is distributed over the complete width of the suction unit.

Malfunction	Possible causes	Troubleshooting	page
Machine does not run	Maschine switched off	• Switch on the keyswitch	24
	Battery plug ^ disconnected	• Reconnect the battery plug to the machine	24
	Main fuse defect	• Check/replace the fuse	29
	Error code on display	• Call your service partner	
Machine does not move	Immobiliser	• Sit on the driver seat	
	Drive pedal activated when switching on	• Make sure no pressure is being applied to the drive pedal, and turn the keyswitch again	
	Parking brake on	• Release the parking brake	25
Batteries not sufficiently charged	Batteries discharged	• Charge batteries	25
	Charger or connecting cable defective	• Call your service partner	
	Battery defect	• Call your service partner	
	Wrong charger type for batteries	• Check and if necessary replace	
Not able to switch off brush or suction unit	Relay defective	• Stop the machine using the battery disconnection socket • Call your service partner	24
Brush does not turn	Brush drive switched off	• Press the brush unit button	24
	Main fuse defect	• Replace fuse	29
	Motor runs but not tool	• Drive belt torn • Call your service partner	
Poor vacuum performance	Suction unit not activated	• Press the suction unit button	24
	Suction hose not connected	• Connect suction hose	26
	Squeegee not on the floor	• Clean the squeegee • Check that the squeegee suspension is functioning correctly	27
	Worn blades	• Replace blades	29
	Floor remains wet		
Soiled solution not picked up	Hose or nozzle blocked (e.g. by pieces of wood or residual material)	• Remove the blockage	
	Suction filter blocked	• Remove the blockage	24
	Indicator lights up but suction unit does not work	• Check fuse and replace if necessary • If the fuse is not defective, call for technical assistance	29
	Squeegee pressure incorrect	• Re-adjust	30
Suction unit switched off	Recovery tank full	• Empty the recovery tank • Check the battery indicator • Check the fuses	27
	Full recovery tank probe soiled	• Check the probe, and clean if necessary	28

Malfunction	Possible causes	Troubleshooting	page
Insufficient out-flow of cleaning solution	Solution tank empty	• Refill the solution tank	27
	Cleaning solution quantity too low	• Choose the volume of cleaning solution with the +/- button	24
	Solution dosing control switched off	• Press the solution button	24

Technical data

Machine type	CO2500	CO3500	
Theoretical performance area operating width x drive speed (7.5) x 1000	5250	6375	m ² /h
Brush width	70	85	cm
Squeegee width	95	108	cm
Solution tank / recovery tank	95	95	l
Machine weight / when ready for operation(max.)	273/633	276/636	kg
Rated voltage	24V	24V	dc
Tools	2 x 35	2 x 43	cm
Brush speed	150	150	min ⁻¹
Brush pressure	52-74	60-102	kg
Dimensions (L x W x H)	169x78x137	169x91x137	cm
Rated power	2000	2000	W
Noise emission level according to EN 60704-1	<70	<70	dB(A)
Total vibration value of hand-arm vibration to ISO 5349	<0.5	<0.5	m /s ²
Splash water protection	IPX3	IPX3	
Protection class	III	III	

Accessories

Nr.	Article	CO2500	CO3500
8501120	Driving disc Instalok 35cm	2X	
8501080	Scrubbing brush 35cm nylon	2X	
8501060	Scrubbing brush for washed concrete 35cm	2X	
8502750	Scrubbing brush abrasive 35cm	2X	
8501130	Driving disc Instalok 43cm		2X
8501100	Scrubbing brush 43cm nylon		2X
8501090	Scrubbing brush for washed concrete 43cm		2X
8502760	Scrubbing brush abrasive 43cm		2X
8502830	Filling hose with universal water coupling	X	X
7508029	Drainage pump	X	X
	Different pads (Polyester brown, blue, red, and contact pad)	X	X

Transport

- Disconnect the battery from the machine using the battery disconnection socket.



Caution:

This machine may only be lifted using a lifting aid, such as a lifting platform for transportation!

Transport the machine in an upright position.

Make sure that the machine is securely fastened within the transportation vehicle and is secured against tipping over.

Refer to page 31 for the dimensions and weights.

Disposal

When it has reached the end of its operational life, the machine and its accessories must be disposed of according to the national regulations. Your TASKI partner can support you with proper disposal upon notification.

Batteries

The batteries must be removed from the machine before being disposed of properly.

Used batteries must be disposed of in an environmentally appropriate way in accordance with the EU guidelines 2006/66/EEC.